

# Unfolding and Dissection of Multiple Cubes, Tetrahedra, and Doubly Covered Squares

ZACHARY ABEL<sup>1,a)</sup> BRAD BALLINGER<sup>2,b)</sup> ERIK D. DEMAINE<sup>3,c)</sup> MARTIN L. DEMAINE<sup>3,d)</sup>  
 JEFF ERICKSON<sup>4,e)</sup> ADAM HESTERBERG<sup>3,f)</sup> HIRO ITO<sup>5,g)</sup> IRINA KOSTITSYNA<sup>6,h)</sup> JAYSON LYNCH<sup>3,i)</sup>  
 RYUHEI UEHARA<sup>7,j)</sup>

Received: November 8, 2016, Accepted: May 16, 2017

**Abstract:** In this paper, we introduce the notion of “rep-cube”: a net of a cube that can be divided into multiple polygons, each of which can be folded into a cube. This notion is inspired by the notion of *polyomino* and *rep-tile*; both are introduced by Solomon W. Golomb, and well investigated in the recreational mathematics society. We prove that there are infinitely many distinct rep-cubes. We also extend this notion to doubly covered squares and regular tetrahedra.

**Keywords:** dissection, folding and unfolding, polyomino, rep-cube, rep-tile

## 1. Introduction

A *polyomino* is a “simply connected” set of unit squares introduced by Solomon W. Golomb in 1954. Since then, sets of polyomino pieces have played an important role in puzzle society (see, e.g., Refs. [7], [9]). In Figure 82 in Ref. [7], it is shown that a set of 12 pentominoes exactly covers a cube that is the square root of 10 units on the side. In this context, there are series of results about the set of polyominoes that covers a cube in recreational math society; see Refs. [4], [5], [6], [10], [12], [13], [14], [15], [16], [17]. There is a comprehensive survey on a web page maintained by Haubrich [11].

In 1962, Golomb also proposed an interesting notion called “rep-tile”: a polygon is a rep-tile of order  $k$  if it can be divided into  $k$  replicas congruent to one another and similar to the original (see Ref. [8], Chap 19 and Ref. [18]).

These notions lead us to the following natural question: is there any polyomino that can be folded to a cube and divided into  $k$

polyominoes such that each of them can be folded to a (smaller) cube for some  $k$ ? That is, a polyomino is a *rep-cube* of order  $k$  if it is a net of a cube, and it can be divided into  $k$  polyominoes such that each of them can be folded to a cube. If each of these  $k$  polyominoes has the same size, we call the original polyomino a *regular rep-cube* of order  $k$ . We note that we do not define crease lines for these nets. That is, although each polyomino consists of unit squares, we may fold along the line that is not orthogonal to the unit squares when we fold to a cube. Simple examples can be found in **Fig. 1**. The first figure indicates two T-shapes that can fold into one cube of size  $\sqrt{2} \times \sqrt{2} \times \sqrt{2}$ . In this net, each T-shape consists of six unit squares and it can fold to a unit cube. On the other hand, gluing these two T-shapes together as shown in the figure, we can fold to a cube of size  $\sqrt{2} \times \sqrt{2} \times \sqrt{2}$ . The dotted lines are not a part of the polyomino which is the net of the cube of size  $\sqrt{2} \times \sqrt{2} \times \sqrt{2}$ , but they are just illustrated to help to understand the squares of size  $\sqrt{2} \times \sqrt{2}$ .

From this viewpoint, we can find some affirmative examples in the previous results. In Refs. [14], [15], [16], we can observe that seven out of eleven developments of a cube have the following property: five copies of each can cover the surface of a cube without overlapping and holes. In our words, there are seven regular rep-cubes of order 5. In Ref. [13], Torbijn also investigated the same notion, which was called *cubic hexomino cubes*, and showed some examples for each  $k = 4, 5, 7, 9, 10^{*1}$ . In this paper, we investigate this notion and show more general results. We first give some regular rep-cubes of order  $k$  for some specific  $k$ . Based on this idea, we give a constructive proof for a series of regular rep-cubes of order  $36gk'^2$  for any positive integer  $k'$  and an integer  $g$  in  $\{2, 4, 5, 8, 9, 36, 50, 64\}$ . That is, there are infinitely many  $k$  that allow regular rep-cube of order  $k$ . We also give some

<sup>1</sup> Mathematics Department, MIT, USA  
<sup>2</sup> Department of Mathematics, Humboldt State University, USA  
<sup>3</sup> Computer Science and Artificial Intelligence Laboratory, MIT, USA  
<sup>4</sup> Department of Computer Science, University of Illinois at Urbana-Champaign, USA  
<sup>5</sup> Graduate School of Informatics and Engineering, the University of Electro-Communications, Chofu, Tokyo 182–8585, Japan  
<sup>6</sup> Computer Science Department, Université libre de Bruxelles, Belgium  
<sup>7</sup> School of Information Science, Japan Advanced Institute of Science and Technology, Nomi, Ishikawa 923–1292, Japan  
<sup>a)</sup> zabel@mit.edu  
<sup>b)</sup> brad@humboldt.edu  
<sup>c)</sup> edemaine@mit.edu  
<sup>d)</sup> mdemaine@mit.edu  
<sup>e)</sup> jeffe@cs.uiuc.edu  
<sup>f)</sup> achesterberg@gmail.com  
<sup>g)</sup> itohiro@uec.ac.jp  
<sup>h)</sup> irina.kostitsyna@ulb.ac.be  
<sup>i)</sup> JaysonL@mit.edu  
<sup>j)</sup> uehara@jaist.ac.jp

\*1 In a preliminary version of this paper presented at JCDCGGG, we have not yet found this article which dealt with the same notion.

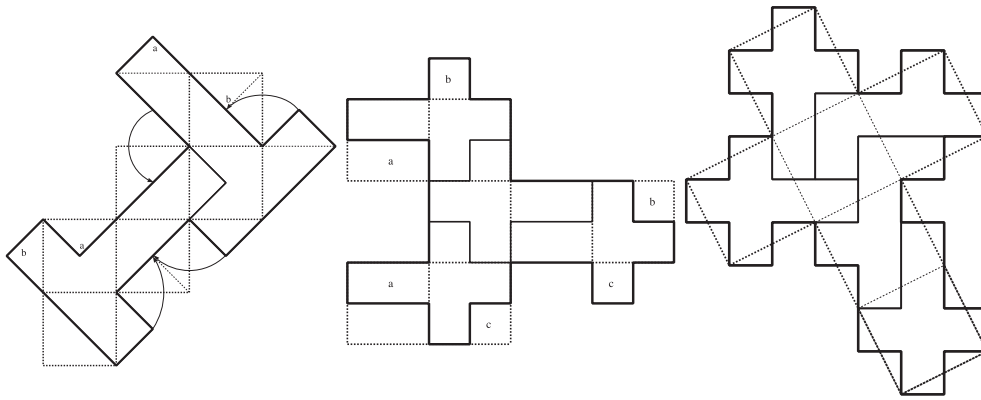

Fig. 1 Rep-cubes of order  $k = 2, 4, 5$ .

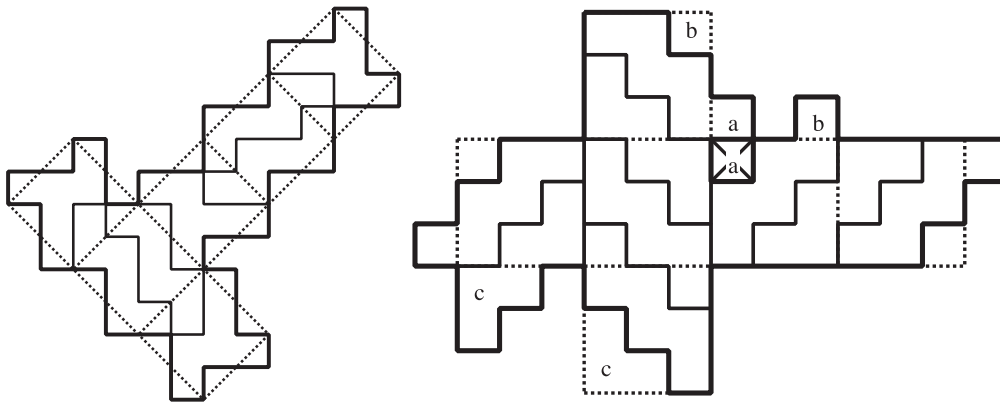

Fig. 2 Rep-cubes of order  $k = 8, 9$ .

non-regular rep-cubes and its variants.

Moreover, we also extend this notion to other dimensions and solids, where each polygon is no longer a polymino. First, we show the universal result for a doubly covered square. That is, for any positive real numbers  $A, a_1, a_2, \dots, a_k$  such that  $\sum_i a_i = A$ , there is a net of a doubly-covered square with area  $A$  that can be cut into  $k$  polygons with areas  $a_1, a_2, \dots, a_k$  such that each of them can be folded into a doubly-covered square. Next, we also show this result can be extended to a regular tetrahedron.

## 2. Results on Rep-Cubes

We first show some specific solutions.

**Theorem 1** There exists a regular rep-cube of order  $k$  for  $k = 2, 4, 5, 8, 9, 36, 50, 64$ .

*Proof.* For each of  $k = 2, 4, 5, 8, 9$ , we give a regular rep-cube in Fig. 1 and Fig. 2. It is not difficult to see that they satisfy the condition of rep-cubes.

For  $k = 36$ , we use six copies of the pattern given in Fig. 3. Using this pattern, we can combine them into any one of eleven nets of a cube.

For  $k = 64$ , we use one copy of the left pattern in Fig. 4 for the bottom of a big cube, four copies of the center pattern in Fig. 4, and one copy of the right pattern in Fig. 4 for the top of the big cube. The consistency can be easily observed.

For  $k = 50$ , we make a program for finding packings of nets of unit cubes on twisted grids on bigger cubes by exhaustive search. We found a packing on a  $(7, 1)$  twist, i.e., a dissection of the surface of a  $\sqrt{50} \times \sqrt{50} \times \sqrt{50}$  cube into 50 nets of unit cubes as

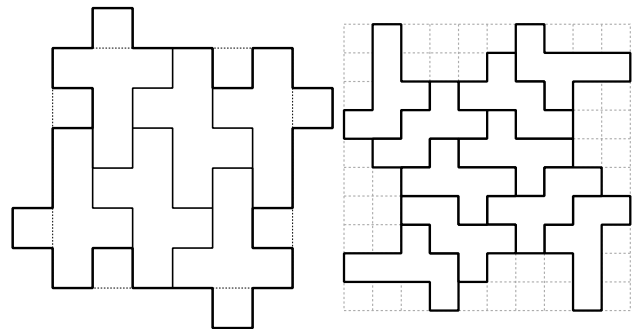

Fig. 3 Pattern for rep-cubes of order  $k = 36$ .

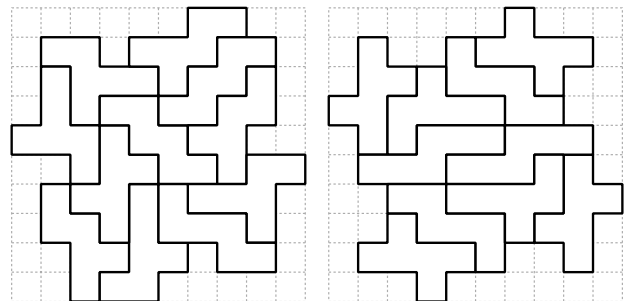

Fig. 4 Patterns for rep-cubes of order  $k = 64$ .

shown in Fig. 5. It is worth mentioning that this pattern contains all eleven edge unfoldings of a cube, while the rep-cube of order  $k = 9$  in Fig. 2 consists of only one kind of them.  $\square$

Based on the solution for  $k = 36$  in Theorem 1, we obtain the following theorem:

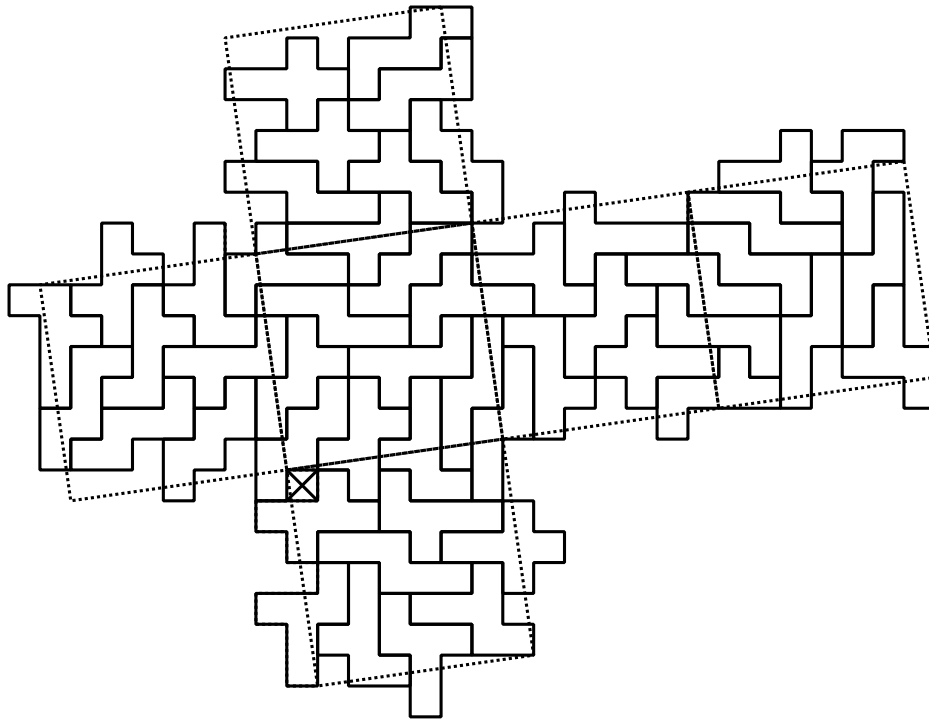

Fig. 5 Pattern for rep-cubes of order  $k = 50$ .

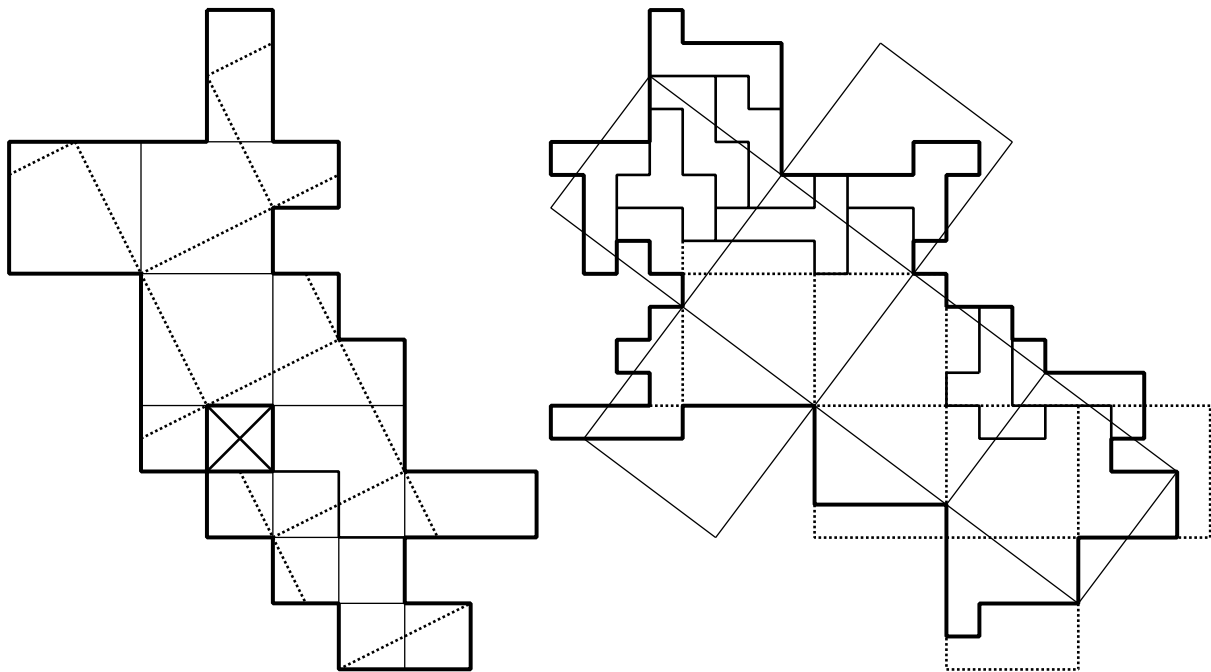

Fig. 6 Patterns for non-regular rep-cubes of order  $k = 2, 10$ .

**Theorem 2** There exists a regular rep-cube of order  $36gk^2$  for any positive integer  $k'$  and an integer  $g$  in  $\{2, 4, 5, 8, 9, 36, 50, 64\}$ . That is, there exists an infinite number of regular rep-cubes. **Proof.** We first choose one pattern in the proof of Theorem 1 according to the value of  $g$ . Next we split each unit square in the pattern into  $k'^2$  small squares. Then we replace each small square by the pattern for  $k = 36$  in Fig. 3. It is not difficult to see that the notches match with each other since they are arranged properly in the pattern. Therefore, we obtain the theorem.  $\square$

One may think that non-regular rep-cubes are more difficult

than regular ones. So far, we have found some:

**Theorem 3** There exists a non-regular rep-cube of order  $k$  for  $k = 2, 10$ .

**Proof.** For  $k = 2$ , the rep-cube is given in Fig. 6 (left): this itself folds to a cube of size  $\sqrt{5} \times \sqrt{5} \times \sqrt{5}$ , and it can be cut into two pieces such that one folds into a cube of size  $2 \times 2 \times 2$ , and the other folds into a unit cube. We note that these areas satisfy  $6 \times (\sqrt{5})^2 = 6 \times 1^2 + 6 \times 2^2 = 30$ .

For  $k = 10$ , the rep-cube is given in Fig. 6 (right): this pattern contains 150 unit squares. It is easy to see that nice nets

of unit cube use 54 unit squares in total. The remaining 96 squares form a net of cube of size  $4 \times 4 \times 4$ . Moreover, this pattern also folds to a cube of size  $5 \times 5 \times 5$ . These areas satisfy  $150 = 6 \times 5^2 = 6 \times (3^2) + 6 \times (4^2) = 6(3^2 + 4^2)$ .  $\square$

### 3. Generalization

One natural extension of the notion of the rep-cube is a different dimension. We first focus on the 2 dimensional case; doubly-covered squares. A *doubly-covered square* consists of two unit squares such that every two corresponding edges of the two squares are glued to each other. A unit doubly covered square has volume 0 and area 2.

Before considering doubly-covered squares, we first show a useful lemma:

**Lemma 4** Let  $P$  be a cylinder of circumference  $a$  and height  $b$ . Then, for any  $0 < \theta \leq 90^\circ$ , we have a common development of  $P$  and the other cylinder  $Q$  that has circumference  $x/2$  and height  $y$  with  $x = \frac{b}{\sin \theta}$  and  $y = a \sin \theta$ .

**Proof.** We give a construction of  $Q$  in Fig. 7. First, we cut the dotted line in Fig. 7 (1). Then we have a parallelogram of edge lengths  $a$  and  $x = \frac{b}{\sin \theta}$ . Rolling it up along the edge of length  $x$ , we have a cylinder of desired size in Fig. 7 (3).  $\square$

We note that by changing  $\theta$  from  $90^\circ$  to any small angle greater than  $0^\circ$ , we can have any long  $x$  greater than or equal to  $b/2$ .

For doubly-covered squares, we have the following theorem:

**Theorem 5** For any positive real numbers  $A, a_1, a_2, \dots, a_k$  such that  $\sum_i a_i = A$ , there is a net of a doubly-covered square with area  $A$  that can be cut into  $k$  polygons with areas  $a_1, a_2, \dots, a_k$ , each of which can be folded into a doubly-covered square.

**Proof.** We first split the doubly-covered square of area  $A$  into  $k$  pieces along horizontal lines so that each piece has area  $a_1, a_2, \dots, a_k$  (see Fig. 8). After the split, we have two pieces of envelope shapes of area  $a_1$  and  $a_k$ , and  $k - 2$  pieces of cylindrical paper strip of area  $a_2, \dots, a_{k-1}$ . We cut two more lines to make two envelope shapes into cylindrical paper strips as well.

Now, we consider the  $i$ th strip of area  $a_k$ . Its circumference is  $2(\sqrt{A}/2) = \sqrt{2A}$ , and hence its height is  $a_k/\sqrt{2A}$ . It is easy to see that  $a_k/\sqrt{2A} < \sqrt{a_k/2}$  since  $a_k < A$ . Therefore, we can apply Lemma 4 to obtain a common development of this  $i$ th cylinder and another cylinder of circumference  $2\sqrt{a_k/2}$  and of height  $\sqrt{a_k/2}$ , which can be glued to a doubly covered square easily.  $\square$

The trick in Theorem 5 also works for regular tetrahedra:

**Theorem 6** For any positive real numbers  $A, a_1, \dots, a_k$  such that  $\sum_i a_i = A$ , there is a net of a regular tetrahedron with area  $A$  that can be cut into  $k$  polygons with areas  $a_1, \dots, a_k$ , each of which can be folded into a regular tetrahedron.

**Proof.** It is known that a tetrahedron of area 4 can be folded by any parallelogram of base of length 2 and height  $\sqrt{3}/2$  (see Fig. 9; the detailed characterization of a regular tetrahedron is given by Akiyama and Nara [3]).

When we cut two skew edges of a regular tetrahedron of area  $A$ , we obtain a cylinder of circumference  $\sqrt{\frac{4A}{3}}$  and of height  $\sqrt{\frac{\sqrt{3}A}{4}}$  (Fig. 10).

Thus, using the same method in the proof of Theorem 5, we

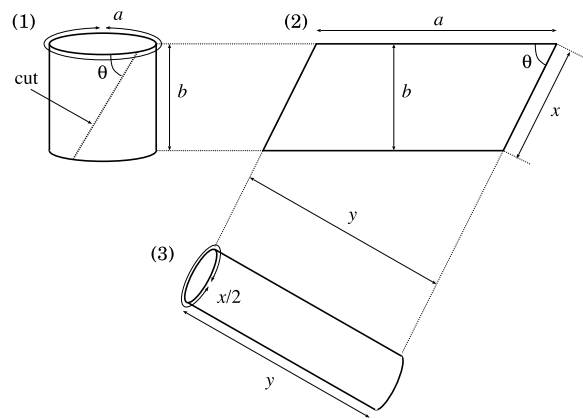

Fig. 7 (1) A cylinder of circumference  $a$  and height  $b$ , (2) a common development of two cylinders, (3) the other cylinder of circumference  $x/2$  and height  $y$ .

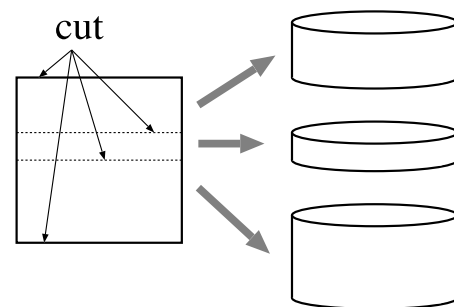

Fig. 8 One doubly-covered square to three doubly-covered squares.

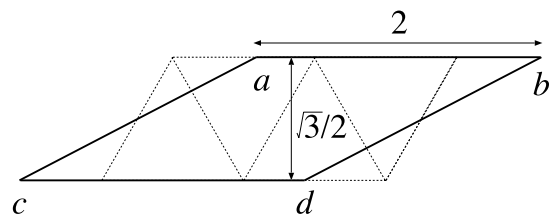

Fig. 9 Any parallelogram of base of length 2 and height  $\sqrt{3}/2$  can fold to a regular tetrahedron; first, glue the edge  $ac$  and  $bd$ , and squash the resulting cylinder along the dotted lines.

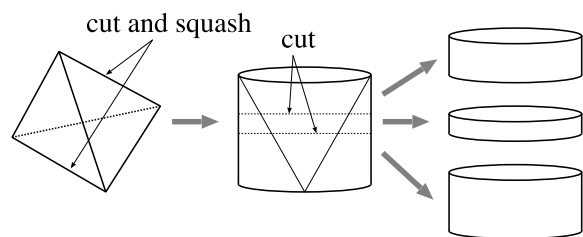

Fig. 10 One regular tetrahedron to three cylinders; each of them can fold to a regular tetrahedron.

obtain the theorem.  $\square$

### 4. Conclusion

In this paper, we introduce a new notion of “rep-cube,” and show several examples. So far, we have no systematic ways to investigate them. However, from the trivial constraint for the areas, we can consider many variants as shown in the last example for  $k = 10$ : Is there a rep-cube of order 6 from a  $3 \times 3 \times 3$  cube into one  $2 \times 2 \times 2$  cube and five  $1 \times 1 \times 1$  cubes, and so on? Especially, one interesting open question is whether there is a rep-cube of or-

der 2 from one  $5 \times 5 \times 5$  cube into one  $4 \times 4 \times 4$  cube and  $3 \times 3 \times 3$  cube. We note that this size comes from the Pythagoras triangle  $3^2 + 4^2 = 5^2$ . We have already known that there are infinitely many Pythagoras triangles. For each of them, can we construct a rep-cube of order 2?

Is there any integer  $k$  such that we have no regular rep-cube of order  $k$ ? It seems to be unlikely that there is a regular rep-cube of order 3. How can we prove that? In this paper, we also introduce “regular” rep-cubes. One natural additional condition may be making every small development congruent; for example, each example for  $k = 2, 4, 9$  satisfies this condition. What happens if we employ this additional condition?

**Acknowledgments** This work was initiated at the 31st Bellairs Winter Workshop on Computational Geometry, co-organized by Erik Demaine and Godfried Toussaint, held on March 18–25, 2016, in Holetown, Barbados. We thank the other participants of that workshop for providing a stimulating research environment. Parts of this paper were presented at JCD-CGGG [2], and WAAC 2016 [1]. This work was partly supported by JSPS/MEXT KAKENHI Grant Numbers 23300001, 24106003, 24106004, 26330009, 15K11985.

## References

- [1] Abel, Z., Ballinger, B., Demaine, E.D., Demaine, M.L., Erickson, J., Hesterberg, A., Ito, H., Kostitsyana, I., Lynch, J. and Uehara, R.: Dissection of Unfolding of Cubes and Its Generalization, *The 19th Japan-Korea Joint Workshop on Algorithms and Computation* (2016).
- [2] Abel, Z., Ballinger, B., Demaine, E.D., Demaine, M.L., Erickson, J., Hesterberg, A., Ito, H., Kostitsyana, I., Lynch, J. and Uehara, R.: Unfolding and Dissection of Multiple Cubes, *Japan Conference on Discrete and Computational Geometry, Graphs, and Games* (2016).
- [3] Akiyama, J. and Nara, C.: Developments of Polyhedra Using Oblique Coordinates, *J. Indonesia. Math. Soc.*, Vol.13, No.1, pp.99–114 (2007).
- [4] Bouwkamp, C.J.: On Benjamin’s Pentomino Cube, Technical report, Eindhoven University of Technology (1997), available from (<http://alexandria.tue.nl/repository/books/508061.pdf>).
- [5] Bouwkamp, C.J.: Tiling the Surface of a Cube by 12 Identical. Pentominoes, Eut report 98-wsk-02, Eindhoven University of Technology (1998), available from (<http://alexandria.tue.nl/repository/books/521176.pdf>).
- [6] Bouwkamp, C.: An Unusual Pentomino Problem, *Cubism For Fun*, Vol.41, pp.39–40 (1996).
- [7] Gardner, M.: *Hexaflexagons, Probability Paradoxes, and the Tower of Hanoi*, Cambridge (2008).
- [8] Gardner, M.: *Knots and Borromean Rings, Rep-Tiles, and Eight Queens*, Cambridge (2014).
- [9] Golomb, S.W.: *Polyominoes: Puzzles, Patterns, Problems, and Packings*, Princeton University (1996).
- [10] Hanegraaf, A.: Covering Cube by 2 Hexominoes, *Cubism For Fun*, Vol.30, pp.27–29 (1992).
- [11] Haubrich, J.: Covering the Surface of a Block by Polyominoes (2006), available from (<http://puzzels.haubrichnet.nl/Arti/Covering/Covering.html>).
- [12] Torbijn, P.: Covering a Cube by 36 Hexominoes, *Cubism For Fun*, Vol.30, p.33 (1992).
- [13] Torbijn, P.: Cubic Hexomino Cubes, *Cubism For Fun*, Vol.30, pp.18–20 (1992).
- [14] Torbijn, P.: General Hexomino Cubes, *Cubism For Fun*, Vol.30 pp.21–26 (1992).
- [15] Torbijn, P.: Covering a Cube with Congruent Polyominoes, *Cubism For Fun*, Vol.58, pp.18–20 (2002).
- [16] Torbijn, P.: Covering a Cube with Congruent Polyominoes (2), *Cubism For Fun*, Vol.59, p.14 (2002).
- [17] Torbijn, P.: Covering a Cube with Congruent Polyominoes (3), *Cubism For Fun*, Vol.61, pp.12–16 (2003).
- [18] Golomb, S.W.: Replicating Figures in the Plane, *Mathematical Gazette*, Vol.48, pp.403–412 (1964).



**Zachary Abel** is a minted Ph.D. from the Department of Applied Mathematics at the Massachusetts Institute of Technology (MIT) working with Professor Erik D. Demaine in the Computer Science and Artificial Intelligence Lab (CSAIL). His primary research is in computational and discrete geometry, including such topics as computational origami and geometry rigidity theory. He received his Bachelors of Arts in Mathematics and Computer Science from Harvard in 2010.



**Brad Ballinger** received his Ph.D. from the University of California, Davis, in 2003. He is now an associate professor in the Mathematics Department at Humboldt State University, where his teaching and research center on the recruitment, preparation, and support of mathematics teachers in the public school setting and issues relating to theoretical computer science.



**Erik D. Demaine** received a B.Sc. degree from Dalhousie University in 1995, and M.Math. and Ph.D. degrees from University of Waterloo in 1996 and 2001, respectively. Since 2001, he has been a professor in computer science at the Massachusetts Institute of Technology. His research interests range throughout algorithms, from data structures for improving web searches to the geometry of understanding how proteins fold to the computational difficulty of playing games. In 2003, he received a MacArthur Fellowship as a “computational geometer tackling and solving difficult problems related to folding and bending—moving readily between the theoretical and the playful, with a keen eye to revealing the former in the latter”. He cowrote a book about the theory of folding, together with Joseph O’Rourke (*Geometric Folding Algorithms*, 2007), and a book about the computational complexity of games, together with Robert Hearn (*Games, Puzzles, and Computation*, 2009).





**Martin L. Demaine** is an artist and mathematician. He started the first private hot glass studio in Canada and has been called the father of Canadian glass. Since 2005, he has been the Angelika and Barton Weller Artist-in-Residence at the Massachusetts Institute of Technology.

Both Martin and Erik work together in paper, glass, and other material. They use their exploration in sculpture to help visualize and understand unsolved problems in mathematics, and their scientific abilities to inspire new art forms. Their artistic work includes curved origami sculptures in the permanent collections of the Museum of Modern Art (MoMA) in New York, and the Renwick Gallery in the Smithsonian. Their scientific work includes over 60 published joint papers, including several about combining mathematics and art.



**Jeff Erickson** is a professor of computer science, University of Illinois at Urbana-Champaign. He is a computational geometer/topologist with more general interests in algorithms, data structures, and lower bounds. He is the area chair for the CS department's theory group.



**Adam Hesterberg** was born in 1989. He received his A.B. degree summa cum laude from Princeton University in 2011 and is now a Ph.D. student at Massachusetts Institute of Technology studying computational geometry and computational complexity.



**Hiro Ito** received B.E., M.E., and Ph.D. degrees in the Department of Applied Mathematics and Physics from the Faculty of Engineering, Kyoto University in 1985, 1987, and 1995, respectively. 1987–1996, 1996–2001, and 2001–2012, he was a member of NTT Laboratories, Toyohashi University of Technology, and

Kyoto University, respectively. Since 2012, he has been a full professor in School of Informatics and Engineering at The University of Electro-Communications (UEC). He has been engaged in research on discrete algorithms mainly on graphs and networks, discrete mathematics, recreational mathematics, and algorithms for big data. Dr. Ito is a member of IEICE, the Operations Research Society of Japan, IPSJ and EATCS.



**Irina Kostitsyna** received her Ph.D. in computer science from Stony Brook University, New York, in 2013. She is a Post-doc in the Algorithms Group at the Computer Science Department at the Université libre de Bruxelles in Belgium. Her main research interests are computational geometry and algorithms.



**Jayson Lynch** is a member of MIT's Computer Science and Artificial Intelligence Laboratory (CSAIL) where he works with Professor Erik D. Demaine. His research interests include computational origami, games and computation, algorithms, and the interplay between physics and computation.



**Ryuhei Uehara** is a full professor in School of Information Science, Japan Advanced Institute of Science and Technology (JAIST). He received B.E., M.E., and Ph.D. degrees from the University of Electro-Communications, Japan, in 1989, 1991, and 1998, respectively. He was a researcher in CANON Inc. during 1991–

1993. In 1993, he joined Tokyo Woman's Christian University as an assistant professor. He was a lecturer during 1998–2001, and an associate professor during 2001–2004 at Komazawa University. He moved to JAIST in 2004. His research interests include computational complexity, algorithms and data structures, and graph algorithms. Especially, he is engrossed in computational origami, games and puzzles from the viewpoints of theoretical computer science. He is a member of IPSJ, IEICE, and EATCS.