

Integrated-optic versus micro-optic devices for fiber-optic telecom systems : a comparison

Citation for published version (APA):

Pennings, E. C. M., Khoe, G. D., Smit, M. K., & Staring, A. A. M. (1996). Integrated-optic versus micro-optic devices for fiber-optic telecom systems : a comparison. *IEEE Journal of Selected Topics in Quantum Electronics*, 2(2), 151-164. <https://doi.org/10.1109/2944.577349>

DOI:

[10.1109/2944.577349](https://doi.org/10.1109/2944.577349)

Document status and date:

Published: 01/01/1996

Document Version:

Publisher's PDF, also known as Version of Record (includes final page, issue and volume numbers)

Please check the document version of this publication:

- A submitted manuscript is the version of the article upon submission and before peer-review. There can be important differences between the submitted version and the official published version of record. People interested in the research are advised to contact the author for the final version of the publication, or visit the DOI to the publisher's website.
- The final author version and the galley proof are versions of the publication after peer review.
- The final published version features the final layout of the paper including the volume, issue and page numbers.

[Link to publication](#)

General rights

Copyright and moral rights for the publications made accessible in the public portal are retained by the authors and/or other copyright owners and it is a condition of accessing publications that users recognise and abide by the legal requirements associated with these rights.

- Users may download and print one copy of any publication from the public portal for the purpose of private study or research.
- You may not further distribute the material or use it for any profit-making activity or commercial gain
- You may freely distribute the URL identifying the publication in the public portal.

If the publication is distributed under the terms of Article 25fa of the Dutch Copyright Act, indicated by the "Taverne" license above, please follow below link for the End User Agreement:

www.tue.nl/taverne

Take down policy

If you believe that this document breaches copyright please contact us at:

openaccess@tue.nl

providing details and we will investigate your claim.

Integrated-Optic Versus Microoptic Devices for Fiber-Optic Telecommunication Systems: A Comparison

Erik Pennings, *Member, IEEE*, Giok-Djan Khoe, *Fellow, IEEE*,
Meint K. Smit, *Associate Member, IEEE*, and Toine Staring

(Invited Paper)

Abstract— We assess the relative merits and prospects of integrated-optics in comparison with microoptic and fiber-based techniques. Firstly, the market for fiber-optic components for telecommunications is analyzed. Secondly, the technological issues which make integrated optics quite different from integrated electronics will be discussed. Thirdly, a specific comparison between the potential of the competing optical technologies will be made for the polarization-diversity hybrid and the optical wavelength (de)multiplexer, two optical devices used in networks that are based on optical frequency division multiplexing (OFDM).

I. INTRODUCTION

INTEGRATED OPTICS has, ever since its inception in 1969 [1], held the promise that the success of integrated electronics could be transferred to the realm of optics. So far, this promise has fallen short of expectations and the market for photonic integrated circuits is still in its infancy. In this paper, we investigate the current status of integrated-optic versus microoptic devices and generate possible explanations for the slow commercialization of integrated-optics. In order to have a practical scope for the paper, the discussion will be confined to optical components for lightwave telecommunication systems, hence to components that have at least one single-mode fiber pigtail.

The single-mode glass fiber is rather important in this context, because it directly affects the viability of waveguide optics. Although single-mode fibers were originally proposed in 1966 [2], attention soon focussed on the graded-index fiber [3]. As it was very difficult to realize integrated optics employing large multimode waveguides, almost all device work concentrated on microoptics at the time. When the use of the graded-index fiber was drastically reduced due to modal noise problems [4], the come-back of the single-mode fiber, thus, also reinvigorated the interest in integrated optics.

Manuscript received August 14, 1996.

E. C. M. Pennings and T. Staring are with Philips Optoelectronics Centre, WAD-1, 5656 AA Eindhoven, The Netherlands.

G.-D. Khoe is with the Technical University of Eindhoven, Faculty of Electrical Engineering EH-12, 5600 MB Eindhoven, The Netherlands.

M. K. Smits with the Delft University of Technology, Faculty of Electrical Engineering, 2628 CD Delft, The Netherlands.

Publisher Item Identifier S 1077-260X(96)09507-X.

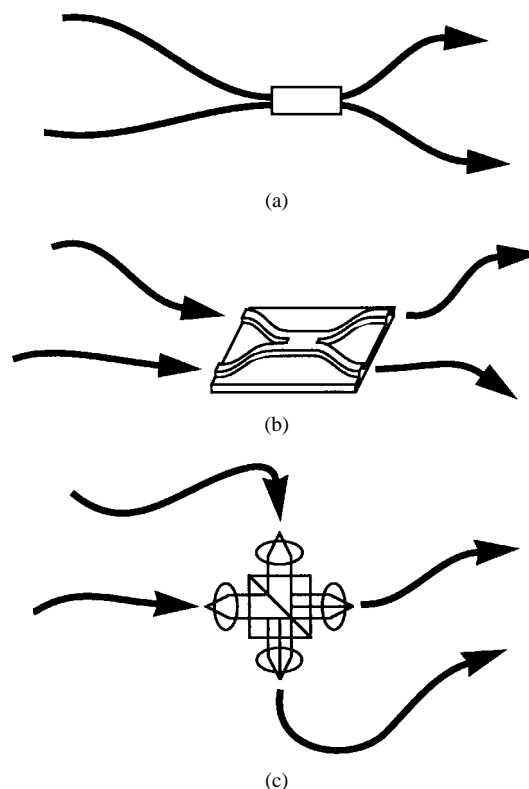

Fig. 1. Illustration of the categories of components considered in this paper, with typical examples: (a) Fiber-based components. Fibers are fused or glued together in a directional coupler. (b) Waveguide-based components. A coupler is made by means of waveguide techniques, fiber pigtailed are subsequently coupled to the interfaces. (c) Microoptics. Bulk optics are used, in combination with fiber pigtailed which are attached to expanded beam lens interfaces. (d) Modules that are assembled from any of the categories just mentioned (not shown).

In this paper, we have distinguished components for lightwave telecommunications into four categories, as illustrated in Fig. 1.

- 1) *Fiber-Based*: Made from fiber, such as couplers, polarizers and filters. Fiber-based components are predominantly fabricated using either the fused-fiber or the side-polishing technique.
- 2) *Integrated-Optic Devices, where Light is Guided in Planar Waveguides*: a) Single-component devices, such

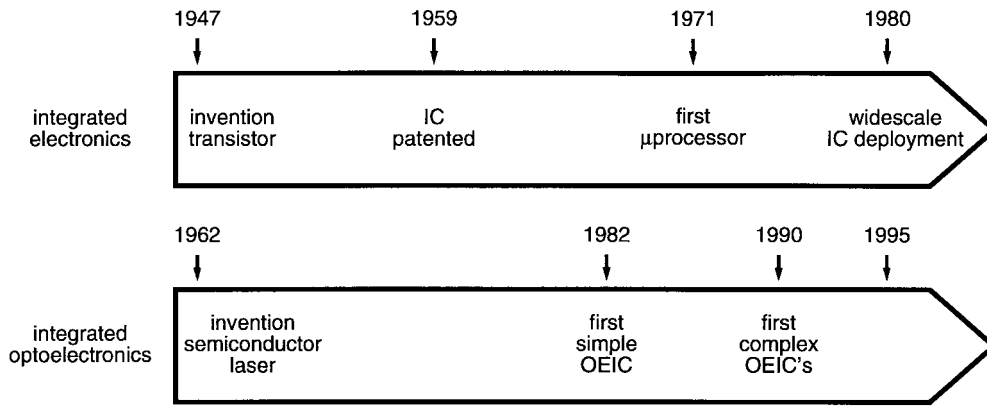

Fig. 2. Time-frames related to the developments of integrated electronics (top) and integrated optics (bottom) on relative time-frames. Progress in the development of integrated optics lags behind electronics.

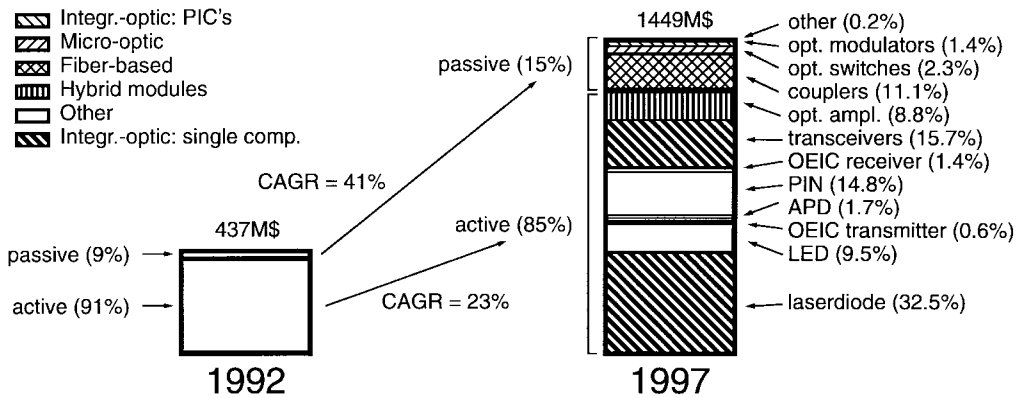

Fig. 3. The 1992 market and 1997 market forecast for fiber-optic components for North America. The CAGR (compounded annual growth rate) percentages, divided into passive and active components, express compound annual growth rates for 1992–1997. Keys to the abbreviations in the figure are: PIC—photonic integrated circuits, OEIC—optoelectronic integrated circuits, PIN—pin photodiode, APD—avalanche photodiode, LED—light-emitting diode.

as lasers, semiconductor optical amplifiers, and phase-modulators and b) photonic integrated circuits (PIC's), where a number of optical elements are monolithically integrated.

- 3) *Microoptic*: Single-component or a combination of components employing techniques where light is not guided, but which rely on diffractive or reflective elements such as lenses or mirrors.
- 4) *Modules*: Assemblies from any of the above categories.

Note that it is the purpose of this paper, considering an increase in functionality in the future, to mainly investigate the potential of photonic integrated circuits, rather than integrated-optic components with a single functionality. We, thus, exclude most lasers and OEIC's, such as PIN/FET combinations from the comparison, but include advanced lasers such as DFB lasers with integrated modulator.

When making the analogy between integrated electronics and integrated optics, one has to bear in mind that there is a large difference in time-frame, as illustrated in Fig. 2. Whereas the starting point for integrated electronics is the invention of the transistor in 1947, the equivalent starting point for integrated optics is the invention of the semiconductor laser diode in 1962, thus 15 years later. The development of integrated electronics continues with the integrated circuit which was patented in 1959, the first microprocessor which was reported

in 1971, and the widescale deployment of the microprocessor in PC's during the 1980's. For optics, the first OEIC was reported in 1978 [5] and complex photonic integrated circuits were reported from 1990 onwards [26]. The time difference in development between integrated electronics and integrated optics, thus, has increased to about 20 years. Based on this analogy, widescale deployment of photonic integrated circuits is not likely to happen before the turn of the century.

II. THE FIBER-OPTIC COMPONENT MARKET

When comparing integrated optics and microoptics, it is a good starting point for the discussion to first identify which components have already established a place in the fiber-optic component market. Fig. 3 shows the fiber-optic component market for 1992 and 1997 in the US. A direct comparison between integrated-optic and microoptic techniques can only be made for passive components and Fig. 3 shows that the comparison therefore applies to the smaller part of the market (15%), since the larger part consists of active devices such as lasers and photodiodes. For passive components, the largest market segment is formed by couplers (11%) which are almost exclusively fiber-based. This shows that the market segments captured by integrated-optic and microoptic products are both quite small (of the order of 1%–2%).

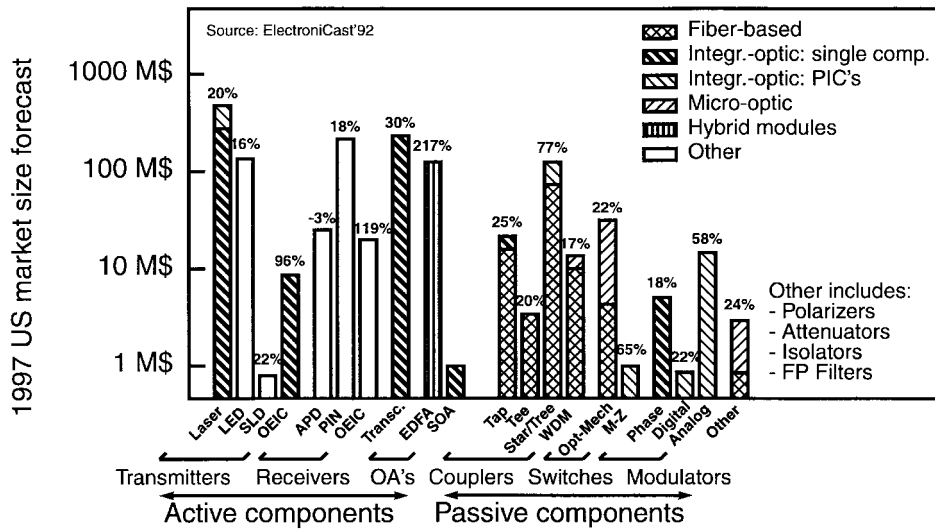

Fig. 4. The 1997 market forecast for fiber-optic components for North America. Specific technologies used for the components are shown. The CAGR percentages for 1992–1997 are given for each type of the components considered. Keys to abbreviations not mentioned earlier in Fig. 3 are: SLD—super luminescent diode, Transc.—transceiver, EDFA—Erbium doped fiber amplifier, SOA—semiconductor optical amplifier, WDM—wavelength division multiplexer, MZ—Mach-Zehnder, FP—Fabry-Perot, OA—optical amplifier.

The microoptic segment consists of products such as switches, isolators/circulators, attenuators, and filters. The integrated-optic segment mainly consists of LiNbO₃ switches and modulators. Another proven integrated-optic product (though active) is the DFB laser with integrated electro-absorption modulator.

The 1997 market forecast for active and passive fiber-optic components for North America is shown in Fig. 4, provided with specific details on the technologies involved and on the CAGR (compounded annual growth rate) for each component.

The market for OEIC's shows a very strong growth, but consists of the integration of optics with electronics such as laser/driver and PIN/FET combinations rather than of an integration of optical elements. Optical amplifier modules show a strong growth as well and contain pump lasers, fiber WDM's and microoptic isolators. Microoptical components have a small but well-established presence in the form of isolators, fiber FP filters, optomechanical switches, and demultiplexers for three or more wavelengths (91% of the demultiplexers involve two wavelengths only and are fiber-based). For advanced PIC's the market is still small at the moment.

One area, where integrated optics seems to have a competitive edge, is in lithiumniobate modulators and in tree couplers, such as 1 × 32 couplers, where integrated-optic couplers are smaller, cheaper and show better port-to-port reproducibility. At the same time, the market for single-function components is very large, consisting of lasers and transceivers. It is likely that these devices will function as “enablers” for more advanced PIC's. Lasers become more advanced leading to three-section DFB or DBR lasers, and DFB lasers with integrated modulators. The success of lithiumniobate modulators allows lithiumniobate foundries to be set up that can also fabricate customized PIC's.

The market analysis shows that the demand for components with a larger degree of optical functionality has been negligible so far. This is important because the competitive

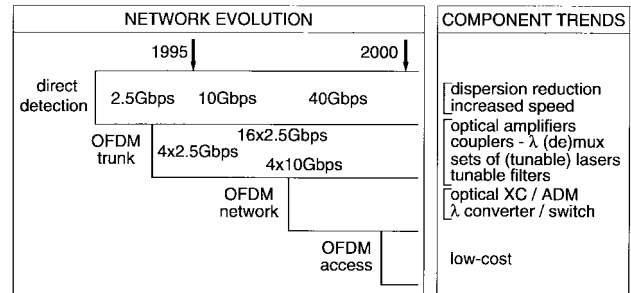

Fig. 5. Expected component trend in relation to optical system evolution. Issues related to dispersion reduction and increased speed will not lead to the massive use of components with complex functionalities. Market for complex optical functionalities is therefore not likely to be substantial before the year 2000. Future developments will depend on the deployment of OFDM (optical frequency division multiplex) techniques in XC's (crossconnects), ADM (add-drop multiplexers) and in the access.

edge for PIC's is precisely in integrating complex optical functionality. This situation, however, is likely to change: the market is not only growing fast (more than 25% a year), but also changing due to the rapid commercialization of OFDM (Optical Frequency Division Multiplex) systems, as illustrated in Fig. 5. However, the first OFDM transmission systems will merely require optical devices with a single functionality, so that the demand for complex optical functionality will only increase later on, i.e., when the wavelength domain is used to realize add-drop multiplexing and cross-connecting functions. Significant cost reduction of the components is required before OFDM systems can be deployed in the access.

One reason for the fact that integrated optics has, up to now, not been able to match the speed of development of integrated electronics is the observation that the market for photonic integrated circuits is still in its infancy, but it is also true that the telecommunication industry is, by tradition, not very market oriented. For example, many of the companies and institutes performing integrated-optics research do not have a direct commercial interest in the component market. In the coming years, substantial changes are expected due to the

deregulation of the telecommunication market and the gradual global break-up of the monopolies of network operators. As a result from the deregulation process and increasing competition, integrated-optics research will, to an increasing extent, be performed by component manufacturers and as a consequence will become more market driven.

III. TECHNOLOGICAL CONSIDERATIONS

It has been argued many times that the competitive edge of photonic IC's comes from increased scale of integration plus the corresponding cost reduction. This argument is in fact based on an implicit analogy between photonic and electronic IC's. This analogy, however, has to be treated with care. Firstly, the markets for photonic and electronic IC's are very different. As was argued in the previous section, the demand for complex optical functionality is still in its infancy. Secondly, there are several technical reasons why photonic and electronic IC's are quite different. In this section, we want to identify the technological factors that make integrated optics differ from integrated electronics. It is these differences that cause the development of photonic integrated circuits to take longer than the corresponding development for integrated electronics.

A. Packaging

It is important to notice that packaging issues form, on one hand, the major economic incentive for integration, but that they, at the same time, form a technical obstacle against integration. Due to difficulties in reducing packaging costs it will take a long time, before integrated optic components with a limited functionality can compete with microoptic or fiber-optic alternatives. The best way to offset packaging costs is to increase the functionality of the chip by integration of multiple components on a single chip. Three specific issues which influence the packaging configuration are the fiber-pigtailing, problems related to components which are sensitive to optical reflections and the need to stabilize the temperature of certain devices.

- 1) *Fiber-Pigtailing*: In electronics, input and output connections are usually simple, unless very high signal frequencies are involved. The single-mode optical fiber connection problem is usually complicated and rather demanding. In fiber-pigtailed lasers, for example, the packaging costs are usually a multitude of the chip costs. Pigtailing costs are very different for a) fiber-matched waveguides such as those based on lithiumniobate or silica, when compared to b) compact waveguides as used in semiconductor optical chips. Fiber-matched waveguides can be coupled relatively easy to fibers, by means of butt-coupling. It is obvious that connections between multiple fibers and multiple waveguides will be even more demanding.

Commercially available integrated-optic couplers, switches and modulators are, therefore, almost exclusively realized with fiber-matched waveguides. Fiber coupling to unmatched waveguides is much more complicated due to the large difference between the fiber

and the (usually) semiconductor waveguide dimensions. The temporary success of multimode fibers was partly due to the fact that it strongly relaxed the coupling problem to the laser. Presently, the coupling problem to single-mode fibers has been solved technically, but fiber coupling to lasers is still expensive and until recently communication lasers were the only semiconductor components which possess sufficient functionality to justify the coupling costs economically. Semiconductor optical amplifiers (SOA's) are the next class of components to take this hurdle.

- 2) *Reflections*: Many fiber-optic communication systems are extremely sensitive to reflections. Optical reflections can cause power fluctuations, noise, nonlinearity, and dispersion. In coherent transmission systems and CATV applications, for example, reflections should be kept below -50 dB. Many components such as narrow linewidth lasers and semiconductor optical amplifiers, therefore, require the use of optical isolators which complicates packaging and increases costs. In addition, on-chip optical isolators are not available for implementation today and there are no breakthroughs in laser designs which may lead to more immunity against optical reflections.
- 3) *Temperature Control*: Accuracy imposed on the optical frequency value of certain components can necessitate the incorporation of Peltier coolers and thermistors. Examples are active components such lasers for use in OFDM systems and passive components such as phased array WDM components for implementation in optical networks.

B. On-Chip Optical Amplification

In electronic IC's compensation of losses is not a problem due to the availability of the amplifier. Until recently there were no means for loss compensation in optical circuits. Unfortunately, losses in optical IC's are often considerable. For example, in semiconductor switching matrices 2–5 dB per switch is not exceptional. The integration scale is therefore strongly restricted by the component losses. In fiber matched waveguide systems component losses are usually much lower. It has to be seen whether on-chip optical amplifiers can be used lavishly to compensate loss in the near future. Spontaneous emission noise may hamper the implementation of large numbers of on-chip amplifiers.

C. Dimensions

Modern transistors have dimensions of only a few microns. Optical couplers or switches in fiber-matched waveguide systems have lengths ranging from many millimeters to several centimeters, so that only a few components can be cascaded on a single wafer. Semiconductor components are usually smaller, but suffer from higher losses. Improvements in waveguide technology and the design of bends have gradually reduced the dimensions of certain optical elements, but the gap with electronics remains large.

D. Feedback Control

Both in optical and electronic IC's it is difficult to accurately control the component parameters. In electronic IC's the feedback principle is used to reduce the sensitivity of the circuit performance to the spread in component performance. In photonic IC's such a principle is not (yet) available. The requirements on process technology are, therefore, much more severe, which is doubly complicating because integrated-optic technology is a young technology and the variety in integrated-optic components which have to be integrated is considerably larger than the variety of components used in electronic IC's today.

E. The Wave Nature of Light

Dealing with optical waveguides leads to issues similar to those encountered in microwave electronics. Optical waveguides can radiate light, leading to loss of power and the possible onset of cross-talk. Similarly, single-mode operation of waveguides is usually desirable, which can complicate PIC design and leads to strict tolerances on waveguide dimensions. Recent work, however, has shown that the single-mode condition can, in many cases, be relaxed by employing the imaging properties of multimode waveguides [50].

In conclusion, one might be tempted to think that integrated-optic components are and will remain futuristic. We do not adhere to that opinion and believe that there is a future for integrated-optic components, but that the following issues deserve attention in order to speed up the commercialization of photonic integrated circuits:

- 1) reduction of packaging and pigtailed costs;
- 2) incorporation of on-chip optical amplification;
- 3) reduction of component size;
- 4) improvement of process technology and development of fabrication-tolerant components.

The last five years have shown tremendous progress. The gradual reduction of packaging costs will broaden the class of components where integrated-optics can compete with microoptic and fiber-based components. The major breakthrough for integrated optics, however, can be expected when both technology and market are ready for photonic integrated circuits with an increased functionality due to larger-scale integration.

IV. POLARIZATION-DIVERSITY

In this section, a specific comparison will be made between the potential of integrated-optic, fiber-based, and microoptic polarization-diversity hybrids. Polarization-diversity hybrids are needed in coherent lightwave receivers and in systems where polarization sensitive components are used.

The wavelength tunability of coherent receivers can be used to construct flexible photonic networks based on optical frequency division multiplexing (OFDM). For such applications, coherent receivers could provide a cost-effective alternative to direct-detection systems, where the cost and performance of the coherent receiver need to be compared to that of a direct-detection receiver in combination with an EDFA preamplifier

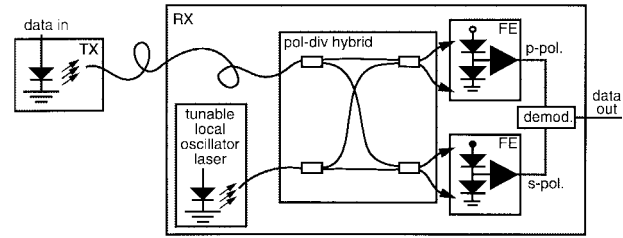

Fig. 6. Schematics of a coherent system employing a polarization diversity receiver. An incoming signal with arbitrary and varying polarization state must be efficiently combined with the local oscillator signal. Key elements in the receiver are the local oscillator laser, a polarization hybrid which consist of optical power splitters and polarization splitters and balanced detectors.

and a narrow tunable filter [47]. Optical front-ends for coherent polarization-diversity receivers have been regarded as prime candidates for monolithic integration and are thus very suitable for a comparison with microoptic and fiber-optic solutions. A coherent system employing the polarization-diversity receiver is shown schematically in Fig. 6.

Most active and passive waveguide-based components are polarization sensitive. Examples are semiconductor optical amplifiers and waveguide-type optical multiplexers and demultiplexers. Substantial efforts are being spent to make these components less polarization sensitive and important progress is being made. Another option to avoid the polarization problem to combine such components with a polarization diversity unit. This solution may become attractive if the polarization sensitive components can be monolithically integrated with the polarization-diversity unit. We will not elaborate this area further and focus on polarization diversity for coherent receivers.

Fig. 7 lists all polarization-diversity hybrids that have to our knowledge been reported in the literature for different competing technologies, tracing their development in time in the form of subcomponents, complete hybrids, packaged versions, systems experiment, and commercial availability. Table I summarizes the parameters of several types of the components.

A. Assemblies

Polarization-diversity hybrids, assembled from separate components, has been used in the first polarization-diversity system experiments which were reported from 1987 onwards by Tokyo University [6], AT&T [7], [8], KDD [9], and others [13]–[15], [17]. Although an assembly can produce a reliable polarization-diversity hybrid ready for field use as was reported by KDD [10] and NTT [16], assembly procedures are cumbersome, and produce rather bulky polarization-diversity hybrids with increased losses, reduced polarization extinction, and reduced robustness when compared to a single component. This soon initiated a trend toward completely fiber-based, microoptic or integrated polarization-diversity hybrids.

B. All-Fiber

All-fiber polarization-diversity hybrids, as shown in Fig. 8, have been fabricated by AT&T [18], using side-polishing techniques, and by Daimler-Benz [20], using fused-fiber tech-

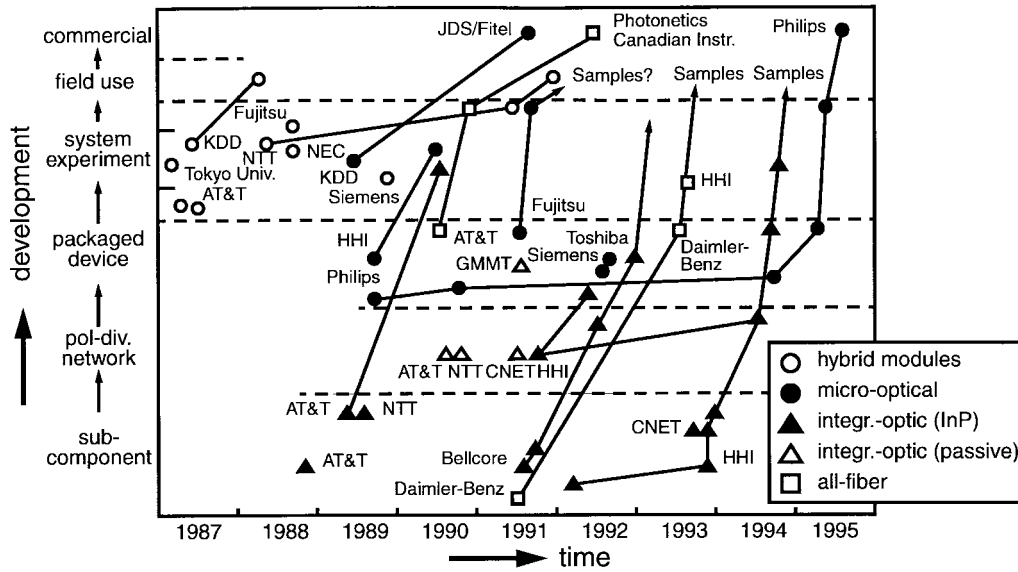

Fig. 7. Overview of reported polarization-diversity networks and their development in time. A distinction is made between integrated optics based on semiconductor (InP), which can be monolithically integrated with active components, and those based on other materials.

TABLE I

Parameter	Fiber Polish / Fused	Micro-Optic	Integr. Optic Passive / InP
Loss (dB)	0.6 / 0.2	0.5 - 1	1 - 3 / 3 - 10
Balance	OK (order of 50 ± 3%)		
Pol.Ext. (dB)	> 15	> 25	> 15
$\Delta\lambda$ (nm)	100 / 20	> 90	> 70
Reflection	OK (< -50dB)		?
# Groups	2	6	9
# System Exp.	1 / 1	4	0 / 2-3
Receiver Sensitivity (dBm) (Polarization Dependence (dB))			
@ 0.14 Gbps	-48.5 (?)		-33.5 (1.4)
@ 0.2 Gbps			-39.7 (no div.)
@ 0.28 Gbps		-43.0 (0.7)	
@ 0.565 Gbps		-43.4 (0.4)	
@ 2.5 Gbps	-38.0 (?)	-39.5 (0.5) -44.0 (0.5)	
Avail. (comm.)	2 / 0	2	0 / 0
Avail. (sample)	0 / 1	1?	0 / 1

nology. All-fiber hybrids offer excellent insertion losses of 0.2–0.7 dB and ultra-low reflection, but they show weak polarization–extinction ratios of around 15 dB. It is illustrative for fiber-optics, that both reported hybrids were immediately used in system experiments [18], [21], and were available either as samples or as a product. The critical component in the fused-fiber hybrid is the polarization splitter [19]. Usable bandwidths are 17 nm for the fused-fiber technology [20] and over 100 nm for the side-polishing technique [18]. The side

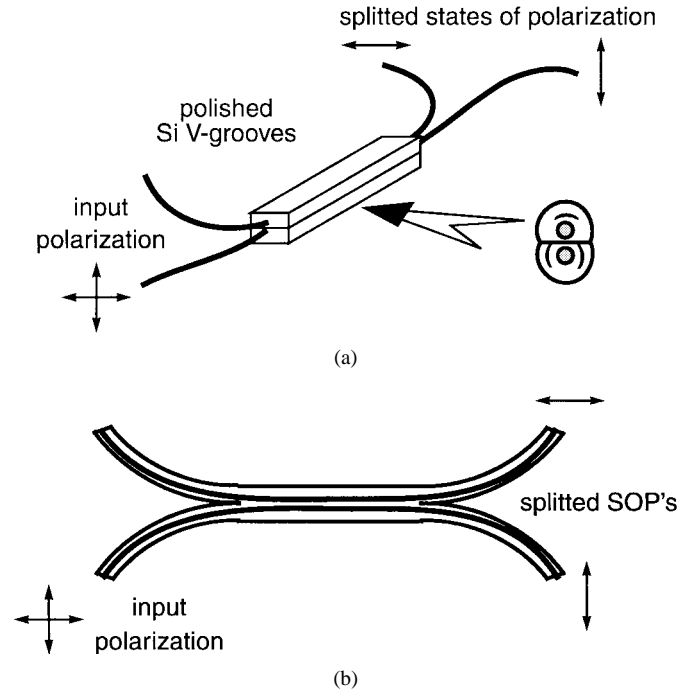

Fig. 8. Illustration of the fiber-based components used in polarization-diversity fiber networks. A side polished version of a fiber polarization splitter (a) is shown on top [18]. The second example (b) is made with the aid of a fused fiber technique [20].

polishing technique, however, may show serious reliability problems due to aging of the epoxy which forms the coupling layer between both fibers.

C. Microoptical

Microoptical polarization-diversity hybrids, in principle, can offer low insertion losses, excellent polarization-handling and ultralow reflection, as demonstrated by Fujitsu [37], and HHI [33]. The main disadvantages of most microoptic designs are the strict tolerances on fabrication and alignment procedures.

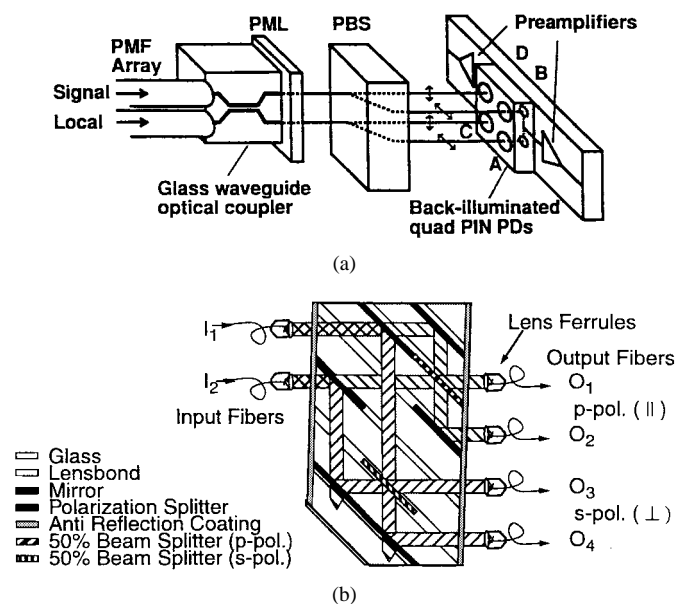

Fig. 9. Examples of diversity optics employing microoptical techniques. The example on top (a) shows a hybrid which contain microoptics and waveguide optics, packaged together with a quad PIN detector [37]. At the bottom, an example is illustrated (b) where critical angle alignments of each expanded beam fiber interface have been avoided owing to a design based on a stack of glass plates with parallel surfaces [46].

The optical beams travelling through the component have to be expanded in diameter and as a result, very severe angle alignment tolerances have to be met to keep losses within reasonable limits. This affects cost, performance and robustness and as a result several microoptical hybrids were reported without subsequent system experiments or commercialization [39], [40].

A different approach minimizing both fabrication and alignment procedures was reported by Philips [46]. This resulted in a high performance hybrid which combines compact size, insertion loss of 0.7 dB, polarization extinction ratio of 25–42 dB, balancing $50\% \pm 3\%$, reflection of less than -58 dB, and usable bandwidth of over 90 nm. Two examples of components made with microoptical techniques are shown in Fig. 9.

Although microoptics requires high-precision manual operations, this does in no way prevent low-cost mass-fabrication as demonstrated by the microoptical recording heads used in CD players.

D. Monolithically Integrated

Monolithically integrated polarization-diversity hybrids were quite promising, but required much more research. The very first device was reported by AT&T [25] and was also immediately used in a system experiment [26], though not polarization-diversity. Much research was still required on subcomponents such as integration of the polarization-rotator (HHI [34]), photodiodes (e.g., AT&T [11]), polarization splitter (Bellcore [31]), FET (CNET [41] and HHI [42]) and laser (AT&T [25], NTT [24], and HHI [45]). In addition, the packaging of such a PIC is far from trivial.

If the laser is not integrated, both a SMF fiber and a PMF fiber need to be coupled to the PIC simultaneously using, for

example, a Si V-groove technique as used by GMMT [28]. If photodetectors are not integrated, such as in the versions made by AT&T [22], NTT [23], CNET [27], and HHI [29], then the output waveguides must be coupled to four fibers, which has not been reported so far, or quad photodetectors need to be packaged together with the hybrid as was reported by HHI [35]. But even if photodetectors are integrated with the hybrid, the high-frequency behavior will still be limited by the electrical connection between the photodetectors and the front-end electronics. If SMA connectors are used between the photodetectors and the electronic front-end, a cutoff frequency of 6 GHz is still achievable (Bellcore [30]), but optimum high-frequency behavior actually requires that either the electronic front-end is placed inside the package (5 GHz, GMMT [28]) or that FET's are integrated as well (1 GHz, HHI [42]).

E. Discussion and Conclusion

Given technological difficulties that needed to be overcome, it is not surprising that only very recently the first system results were reported employing a polarization-diversity receiver PIC, as shown in Fig. 10, which is made by HHI [48], yielding a best receiver sensitivity of -33.5 dBm for a 140-Mb/s FSK system.

Despite of quite impressive achievements in the field of monolithic integration, PIC's are still not competitive with fiber-based or microoptic polarization-diversity hybrids for a number of reasons. Firstly insertion losses are considerably larger for integrated-optic than for either fiber-based or microoptic solutions. Secondly, coherent systems are extremely sensitive to reflections, which are required to be smaller than -50 dB.

So far, the influence of reflections by photonic integrated circuits has been little studied and often neglected, but there is growing evidence that PIC's cause nonnegligible reflections, not only by the facets, but also by integrated-optic elements and by active/passive transitions [49], [51]. Also, monolithic integration of many different optical functions on a single chip constitutes a compromise on the performance of each single element, so that overall system performance does not match the system performance achieved when using separate components. It is, therefore questionable whether there will be a market for polarization diversity PIC's since they have to outperform their fiber-based or microoptic counterparts, or they have to be much cheaper which, however, will put serious constraints on the total PIC size.

V. (DE)MULTIPLEXERS

In this section, a specific comparison is made for the wavelength demultiplexer for dense WDM applications in OFDM systems. The development of these demultiplexers is shown in Fig. 11. WDM is used in point to point transmission links to enhance the capacity of the system and is currently being studied for implementation in future optical networks in order to improve the flexibility and upgradability of those networks. A point to point link using WDM is shown in Fig. 12.

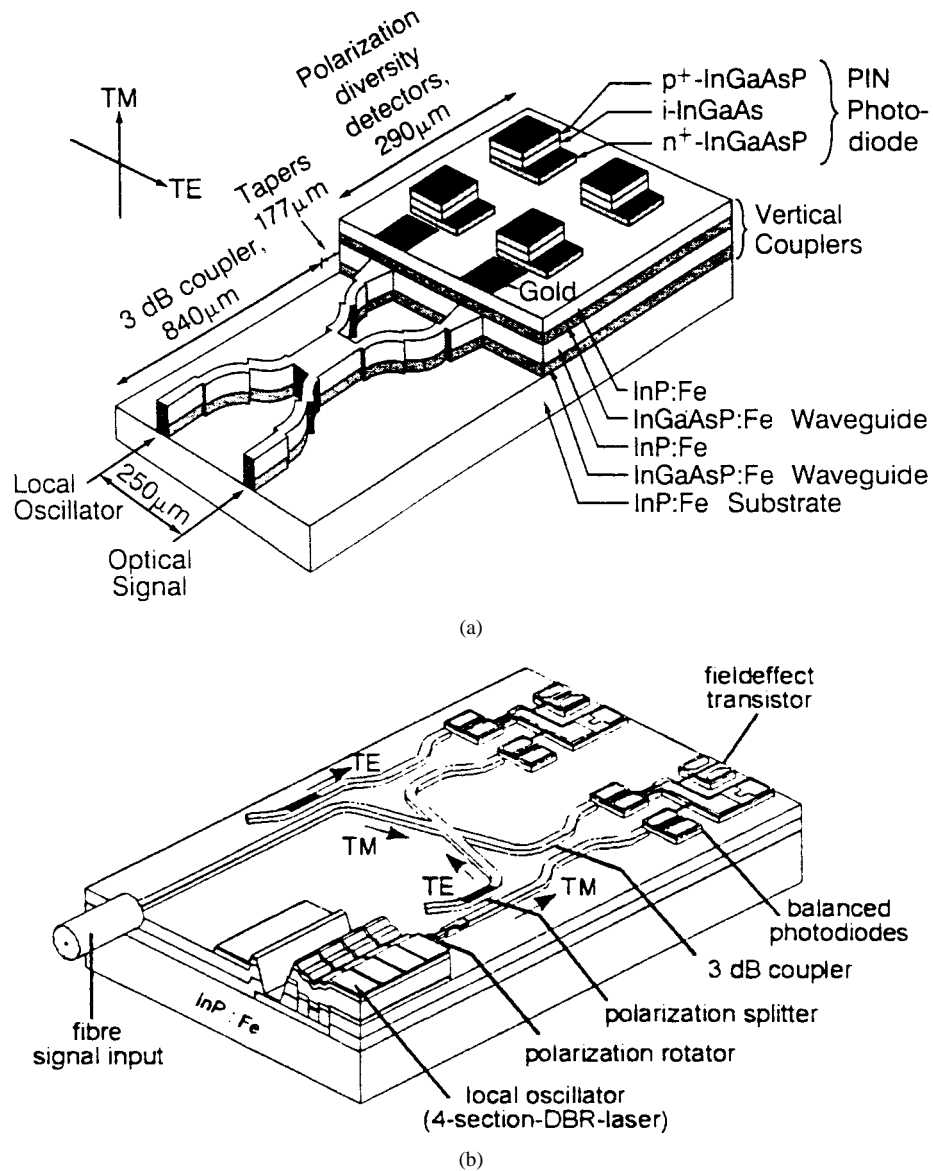

Fig. 10. Monolithically integrated polarization diversity hybrids. The first example shown on top (a) combines polarization diversity detectors with a polarization-independent 3-dB coupler [30]. The second example (b) also includes a local oscillator laser and field-effect transistors [48].

A. Fiber-Based

Two-wavelength fiber-based demultiplexers are mainly used as duplexers for two-channel communication ($1.3/1.5 \mu\text{m}$), or are employed in EDFA's ($0.98/1.55 \mu\text{m}$ and $1.48/1.55 \mu\text{m}$). The market for WDM couplers consists for about 90% of duplexers and is completely dominated by fiber-couplers. It is, therefore, unsuitable for a comparison between microoptics and integrated optics. For dense WDM applications in OFDM networks on the other hand, fiber-based couplers are less suitable because they need to be cascaded [90], [91]. This market relies entirely on microoptics or integrated optics, as can be seen in Fig. 11.

B. Modules

Fibers can, of course, be used in combination with filters to realize wavelength demultiplexers for dense WDM. These filters can be placed in series (cascaded) or in parallel by using a fiber splitter. Examples with cascaded and parallel

filters and a fiber splitter are shown in Fig. 13. The filters can be of a variety of types. Tunable fiber Fabry-Perot filters are commercially supplied by, for example, Micron Optics and Queensgate. Fixed interference filters are offered by, among others, OCA and JDS, and the performance in a system is reported [92]. Experiments employing fiber duplexers for DWDM [90] and using fiber Bragg gratings [91] have also been reported.

C. Microoptics

Fig. 11 shows that much of the work on microoptical demultiplexers was already carried out in the early eighties when multimode fibers were used with wavelengths of in the range of 700–900 nm. Microoptical wavelength demultiplexers can be divided into the cascaded interference filter type and the grating-based type.

In the early eighties, a large number of microoptical (de)multiplexers were published. This focus was due to the fact

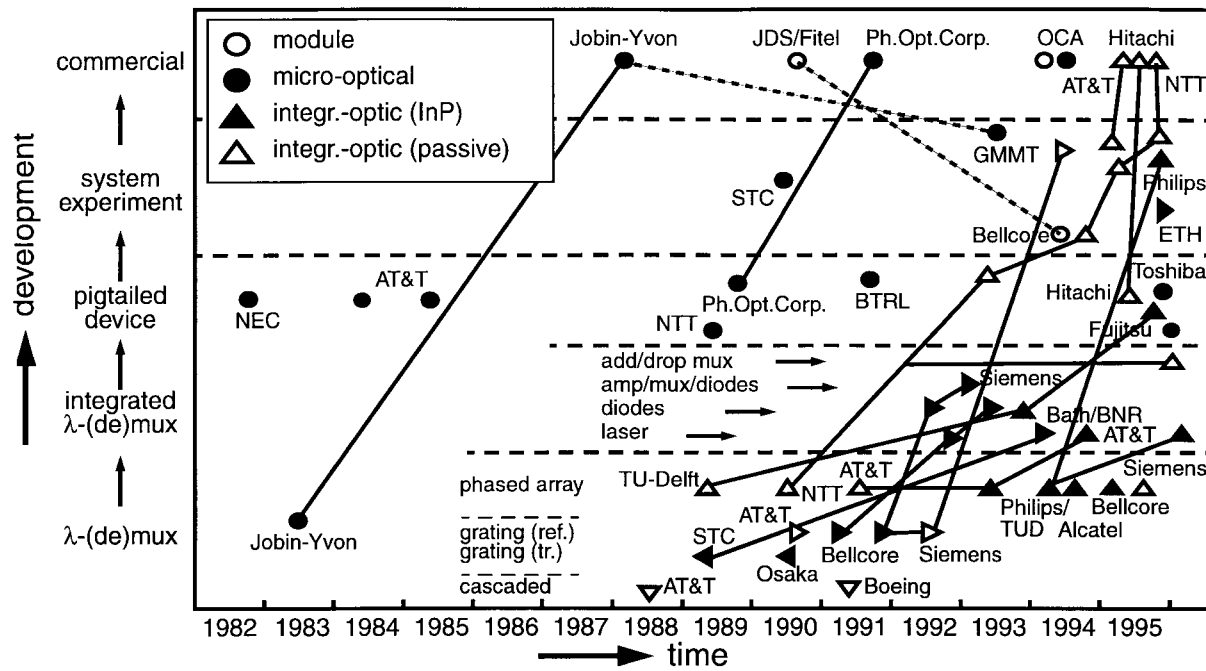

Fig. 11. Overview of reported wavelength demultiplexers and their development in time for DWDM (Dense Wavelength Division Multiplex).

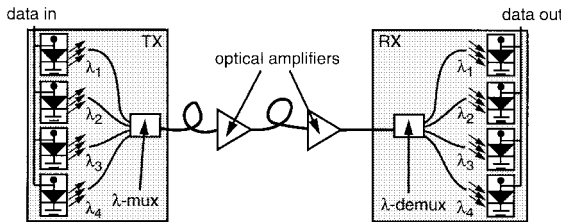

Fig. 12. Principle of an optical point to point system employing wavelength multiplexers and demultiplexers. Key specifications of the WDM components are the optical loss, the maximum number of wavelength channels, the spacing between the channels, the 3-dB bandwidth of the optical passband of each channel, polarization dependence of the location of the passbands and the influence of temperature.

that microoptics is the natural solution for multimode fiber-based systems, which were dominant in the early eighties as explained in the introduction. Although some demultiplexer designs employ dichroic or interference filters, such as those made by NTT [88] and OCA, most microoptical WDM designs use collimating optics and a reflecting grating, such as those made by Jobin-Yvon [89], STC [94], NEC [84], AT&T [86], [93], BTRL [85], and Physical Optics Corporation [87]. The designs of OCA and Jobin-Yvon are illustrated in Fig. 14.

Despite the availability of good components only a few publications on WDM transmission experiments explicitly mention the use of wavelength demultiplexers, examples are reports by STC [94] and GMMT [95]. Most WDM system experiments at that time use ordinary couplers and filters to perform the (de)multiplexing function. Obviously the emergence of WDM transmission systems did not automatically create a market for demultiplexers.

In the second half of the eighties, research on microoptic WDM's slowed down due to the advent of the monomode fiber and a shift of interest to coherent systems. When the interest in WDM returned in the early nineties because of the need to enhance transmission capacity, previously developed

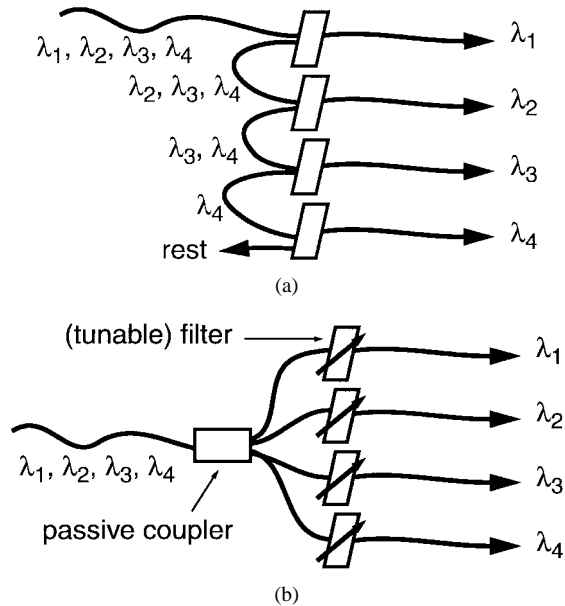

Fig. 13. Demultiplexers which combine fiber components and filters: (a) with the filters in cascade, and (b) with the filters in parallel.

microoptic (de)multiplexers were conveniently introduced on the market. Research in OFDM networks has further increased the interest in WDM components. Recently, the phased array design, which is typical for integrated optics discussed in the following section, has also been realized in microoptics [96].

D. Integrated-Optic

Starting at the end of the eighties an increasing number of integrated-optic devices is reported. Early planar demultiplexers relied on cascaded duplexers, such as Mach-Zehnder filters as reported by AT&T [52], or as interference couplers such as made by Boeing [81]. Later on, focusing elements and

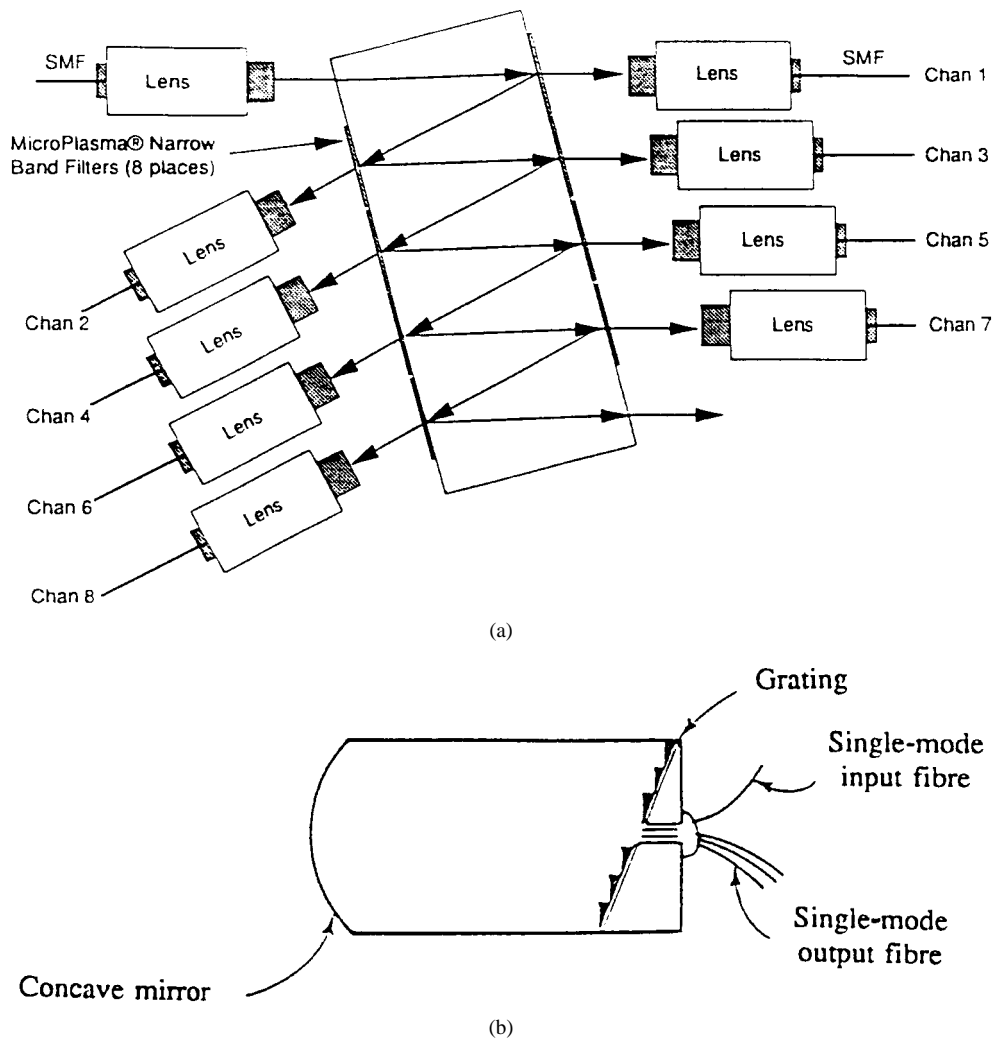

Fig. 14. Microoptic type demultiplexers which are commercially available. The example on top (a), made by Optical Corporation of America, is based on cascaded narrowband filters [104] aligned between expanded beam fiber interfaces. The other example (b), made by Jobin-Yvon, is based on a combination of a concave mirror and a grating [89].

dispersive gratings were used, such as realized by STC/BNR [79], [80], thus creating a planar equivalent of the microoptical design. In a subsequent period in time, devices combined dispersive and focusing properties in a single (curved) reflecting grating, such as those reported by Bellcore [66]–[68] and Siemens [70]–[74]. A module containing an InP grating demultiplexer and pin-JFET receiver array is made recently by ETH [97].

A problem for grating-based devices is formed by the reflection loss of the grating (>6 dB), which is extremely sensitive to the steepness of the reflecting sidewall. This problem is avoided by applying an optical phased array as the focusing and dispersive element. The concept, proposed by TU Delft [54]–[58], has now found widespread application, for example by NTT [59]–[62], AT&T [63]–[65], Philips [76], Alcatel [77], [78], Bellcore [69], Hitachi [83], and Siemens [75].

Since 1992, realization of integrated devices combining (de)multiplexers with detectors have been reported by Siemens [71], [72], Bellcore [68], and TU Delft [57], [58]. Combinations with lasers were made by Bellcore [67], AT&T [65], and

Bath University [80]. An add-drop multiplexer has been made using the phased array (de)multiplexer [98].

First system experiments were carried out by NTT [61], [62] using an add-drop filter and by Siemens [74] using a multiwavelength receiver. Recently more system experiments have been carried out [99]–[101]. These experiments apply silica-based components. A system experiment with InP-based components has been carried out by TU Delft and Philips [102].

E. Discussion and Conclusion

At present, high-performance microoptic (de)multiplexers are commercially available. However, integrated optical components are rapidly approaching the commercial stage. For example, AT&T, Hitachi, and NTT recently introduced the first integrated-optic demultiplexers. The performance of these (de)multiplexers compares well with their microoptic counterparts, as shown in Table II. In addition, multiwavelength networks, employing direct detection schemes, combine modest component requirements with the level of integration (e.g., in add-drop filters or optical cross-connects) where scaling

TABLE II

technique	type	N	$\Delta\lambda$ (nm)	ins. loss (dB)	ret. loss (dB)	x-talk (- dB)	drift (nm/°C)	pol.dep. (dB)	Vendor
module	splitter + FFP-filter			<1.5-2.5	?	?	act. tuning	<0.5	Micron Optics
				<4	>22-40	?	act. tuning	?	Queensgate
	cascaded filter			<1.5	>40-55	>15	0.004	?	OCA
4		4	<2.2-4.3	>45	>20	0.06	<0.1	JDS	
micro-optic	cascaded filter	4-8	1.6	<3-4	>40-55	>30	0.004	<0.1	OCA
	grating	4-41	1 - 16	<3-5	?	>30-55	0.02-0.004	?	Jobin-Yvon
integr. opt.	PHASAR (passive)	8	?	<10	>25	>20	?	<1	Hitachi
		8	1.61	<10	>30	>20	0.01(tuning)	?	AT&T
		4-32	0.8 - 2	<6-7	>40	>20-22	Peltier/NTC	<0.3	NTT

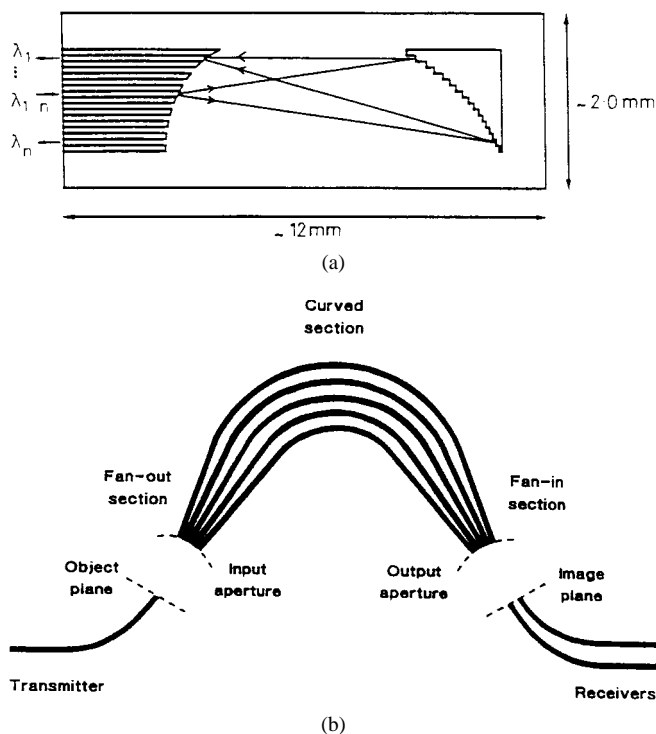

Fig. 15. Two examples of integrated type optical demultiplexers: (a) with a planar reflection grating [66] and (b) with a phased array design [55].

effects might provide integrated optics with a competitive edge over other techniques.

The performance of a variety of commercial demultiplexers is compared in Table II. The splitter plus filter configuration is rather popular due to its simplicity and tunability, but it poses an intrinsic splitter loss of $10 * \log(N)$ and may show unwanted back-reflections. Fixed demultiplexers will gain in importance, as soon as WDM channels have been standardized. For cascaded filters, the loss increases proportional to number of channels, which may limit its suitability to 4–8 channels.

Microoptic demultiplexers offer proven reliability in addition to excellent performance in terms of number of channels, insertion loss, cross-talk, polarization-dependence and thermal

stability [103]. Integrated-optic demultiplexers, especially the phased array type, have seen an enormous development and the recently commercialized Si-based demultiplexers show a very competitive performance. The performance of these commercial versions can, however, not yet match that of microoptic versions. This leads us to conclude that the real breakthrough for WDM integrated optics has to be expected when both technology and market are ready for photonic IC's with increased functionality due to a larger scale of integration.

VI. CONCLUSION

In this paper, the status of integrated-optics has been reviewed in comparison with microoptic and fiber-based technology. Early expectations of integrated optics based on the analogy with the success of integrated electronics, were found to be ill-based considering the many differences between integrated optics and integrated electronics.

For two components in OFDM networks, a specific comparison has been made between integrated-optic, microoptic and fiber-optic solutions. Presently, integrated-optic polarization-diversity solutions can not compete with fiber-optic or microoptic solutions, and it seems unlikely that they will in the future.

For dense WDM, competitive microoptical wavelength-demultiplexers are commercially available, but market developments, technological considerations and scale of integration seem to be advantageous for integrated-optic solutions, as indicated by recent introductions of integrated-optic demultiplexers. Although these developments are promising, we do not expect a major breakthrough of integrated-optic components before the turn of the century.

Finally, it should be noted that the different optical technologies cannot be too sharply distinguished. A butterfly-packaged digital telecommunication laser, for example, incorporates, apart from the laser, a Peltier cooler, a monitor photodiode, an NTC element, an isolator, fiber-chip coupling optics, and an internal bias and impedance matching network, so that it is more appropriate to view the laser as a hybrid module than as a planar waveguide component. As different technologies become more mature, the best solution for each individual

application very likely consists of combining the best fiber-based, microoptic or integrated-optic subcomponents in a single module.

REFERENCES

- [1] S. E. Miller, "Integrated optics: An introduction," *Bell Syst. Tech. J.*, vol. 48, no. 7, pp. 2059–2069, 1969.
- [2] K. C. Kao and G. A. Hockham, "Dielectric-fiber surface waveguides for optical frequencies," *Proc. Inst. Elect. Eng.*, vol. 113, no. 7, 1966, pp. 1151–1158.
- [3] D. Gloge and E. A. J. Marcatili, "Multimode theory of graded-core fibers," *Bell Syst. Tech. J.*, vol. 52, no. 9, pp. 1563–1578, 1973.
- [4] K. O. Hill, Y. Tremblay, and B. S. Kawasaki, "Modal noise in multimode fiber links: Theory and experiment," *Opt. Lett.*, vol. 5, no. 6, pp. 270–272, 1980.
- [5] C. P. Lee, S. Margalit, I. Ury, and A. Yariv, "Integration of an injection laser with a Gunn oscillator on a semi-insulating GaAs substrate," *Appl. Phys. Lett.*, vol. 32, no. 12, pp. 806–807, 1978.
- [6] T. Okoshi and Y. H. Cheng, "Four-port homodyne receiver for optical fiber communications comprising phase and polarization diversities," *Electron. Lett.*, vol. 23, no. 8, pp. 377–378, 1987.
- [7] L. D. Tzeng, W. L. Emkey, C. A. Jack, and C. A. Burrus, "Polarization-insensitive coherent receiver using a double balanced optical hybrid system," *Electron. Lett.*, vol. 23, no. 22, pp. 1195–1196, 1987.
- [8] T. E. Darcie, B. Glance, K. Gayliard, J. R. Talman, B. L. Kaspar, and C. A. Burrus, "Polarization-diversity receiver for coherent FSK communications," *Electron. Lett.*, vol. 23, no. 25, pp. 1369–1371, 1987.
- [9] S. Ryu, S. Yamamoto, and K. Mochizuki, "Polarization-insensitive operation of coherent FSK transmission system using polarization diversity," *Electron. Lett.*, vol. 23, no. 25, pp. 1382–1384, 1987.
- [10] S. Ryu, S. Yamamoto, Y. Namihira, K. Mochizuki, and H. Wakabayashi, "First sea trial of FSK heterodyne optical transmission system using polarization diversity," *Electron. Lett.*, vol. 24, no. 7, pp. 399–400, 1988.
- [11] S. Chandrasekhar, J. C. Campbell, F. G. Storz, A. G. Dentai, C. H. Joyner, and G. J. Qua, "Balanced dual photodiodes integrated with a 3 dB directional coupler for coherent lightwave receivers," *Electron. Lett.*, vol. 24, no. 23, pp. 1457–1458, 1988.
- [12] S. Ryu, K. Mochizuki, and H. Wakabayashi, "Pattern independent FSK polarization diversity transmission experiment using a laser module with built-in LiNbO₃ waveguide phase modulator as external cavity," in *Proc. 7th IOOC*, Kobe, Japan, July 18–21, 1989, paper 18C2–2.
- [13] S. Watanabe, T. Naito, T. Chikama, T. Kiyonaga, Y. Onada, and H. Kuwahara, "Polarization-insensitive 1.2 Gb/s optical DPSK heterodyne transmission experiment using polarization diversity," in *Proc. 14th ECOC*, Brighton, U.K., Sept. 11–15, 1988, pp. 90–93.
- [14] T. Imai, "Polarization diversity receiver using a simple weight controller for coherent FSK communications," *Electron. Lett.*, vol. 24, no. 15, pp. 979–980, 1988.
- [15] M. Shibutani, S. Yamazaki, and S. Murata, "Polarization diversity coherent optical receiver with a balanced receiver configuration," in *Proc. 14th ECOC*, Brighton, UK, Sept. 11–15, 1988, pp. 151–154.
- [16] T. Imai, N. Ohkawa, Y. Hayashi, and Y. Ichihashi, "Polarization diversity detection performance of 2.5-Gb/s CPFSK regenerators intended for field use," *J. Lightwave Technol.*, vol. 9, pp. 761–769, June 1991.
- [17] R. Noé, H. Rodler, G. Gaukel, B. Noll, and A. Ebberg, "High-performance, two-channel optical FSK heterodyne system with polarization diversity receiver," *Electron. Lett.*, vol. 26, no. 15, pp. 1109–1110, 1990.
- [18] J.-M. P. Delavaux, Y. K. Park, S. Barski, H. Lefevre, M. Failes, and C. Warner, "All-fiber optical hybrid for coherent polarization diversity receivers," *Electron. Lett.*, vol. 26, no. 16, pp. 1303–1305, 1990.
- [19] M. Eisenmann and E. Weidel, "Single-mode fused biconical coupler optimized for polarization beamsplitting," *J. Lightwave Technol.*, vol. 9, pp. 853–858, July 1991.
- [20] R. Deufel, M. Eisenmann, H. Gottsmann, B. Hillerich, A. Schurr, and E. Weidel, "All-fiber optical frontend for a balanced polarization diversity receiver with 0.2 dB excess loss and high noise rejection," *J. Opt. Commun.*, vol. 14, no. 3, pp. 96–100, 1993.
- [21] U. Hilbk, H. Bunning, M. Burmeister, E. Grossmann, Th. Hermes, B. Hoen, P. Meissner, F. Raub, J. Saniter, F. Schmidt, and F. J. Westphal, "Eight-channel coherent TV distribution system with all-fiber optical frontends," in *Proc. OFC'91*, San Diego, CA, Feb. 18–22, 1991, paper ThC1.
- [22] Y. Shani, C. H. Henry, R. C. Kistler, R. F. Kazarinov, and K. J. Orlowsky, "Integrated optic front end for polarization diversity reception," *Appl. Phys. Lett.*, vol. 56, no. 21, pp. 2092–2093, 1990.
- [23] T. Oguchi, A. Sugita, and J. Noda, "Integrated polarization diversity front end optics," *IEEE Photon. Technol. Lett.*, vol. 2, pp. 830–831, Nov. 1990.
- [24] H. Takeuchi, K. Kasaya, Y. Kondo, H. Yasaka, K. Oe, and Y. Imamura, "Monolithic integrated coherent receiver on InP substrate," *IEEE Photon. Technol. Lett.*, vol. 1, pp. 398–400, Nov. 1989.
- [25] T. L. Koch, U. Koren, R. P. Gnall, F. S. Choa, F. Hernandez-Gil, C. A. Burrus, M. G. Young, M. Oron, and B. I. Miller, "GaInAs/GaInAsP multiple-quantum-well integrated heterodyne receiver," *Electron. Lett.*, vol. 25, no. 24, pp. 1621–1623, 1989.
- [26] T. L. Koch, F. S. Choa, U. Koren, R. P. Gnall, F. Hernandez-Gil, C. A. Burrus, M. G. Young, M. Oron, and B. I. Miller, "Balanced operation of a GaInAs/GaInAsP multiple-quantum-well integrated heterodyne receiver," *IEEE Photon. Technol. Lett.*, vol. 2, pp. 577–580, Aug. 1990.
- [27] J. Saulnier, C. Ramus, F. Huet, and M. Carre, "Optical polarization-diversity receiver integrated on titanium-diffused lithium niobate," *IEEE Photon. Technol. Lett.*, vol. 3, pp. 926–928, Oct. 1991.
- [28] J. Hankey, P. T. Johnson, R. Cush, C. A. Park, and M. Owen, "A balanced polarization diversity receiver using hybrid assembly methods and its use in optical coherent multichannel systems," in *Proc. 17th ECOC/IOOC*, Paris, France, Sept. 9–12, 1991, paper TuC4-2.
- [29] H. Heidrich, M. Hamacher, P. Albrecht, H. Engel, D. Hoffmann, D. Imhof, H.-P. Nolting, F. Reier, and C. M. Weinert, "Polarization diversity waveguide network integrated on InP for a coherent optical receiver front-end," in *Proc. 17th ECOC/IOOC*, Paris, France, Sept. 9–12, 1991, paper TuC4-3.
- [30] R. J. Deri, E. C. M. Pennings, A. Scherer, A. S. Gozdz, C. Caneau, N. C. Andreadakis, V. Shah, L. Curtis, R. J. Hawkins, J. B. D. Soole, and J.-I. Song, "Ultrapact monolithic integration of balanced, polarization diversity photodetectors for coherent lightwave receivers," *IEEE Photon. Technol. Lett.*, vol. 4, pp. 1238–1240, Nov. 1992.
- [31] R. J. Deri, R. J. Hawkins, C. Caneau, E. C. M. Pennings, and N. C. Andreadakis, "Ultrapact monolithic integration of polarization diversity waveguide/photodiodes," *Appl. Phys. Lett.*, vol. 59, no. 15, pp. 1823–1825, 1991.
- [32] G. D. Khoe, K. G. Wright, and H. A. van Esch, "Low loss integrated polarization diversity device with standard coatings and low assembly tolerance," in *Proc. 16th ECOC*, Amsterdam, The Netherlands, Sept. 16–20, 1990, pp. 411–414.
- [33] R. Langenhorst, W. Pieper, M. Eiselt, D. Rohde, and H. G. Weber, "Balanced phase and polarization diversity coherent optical receiver," *IEEE Photon. Technol. Lett.*, vol. 3, pp. 80–82, Jan. 1991.
- [34] H. Heidrich, P. Albrecht, M. Hamacher, H.-P. Nolting, H. Schroeter-Janssen, and C. M. Weinert, "Passive mode converter with a periodically tilted InP/GaInAsP rib waveguide," *IEEE Photon. Technol. Lett.*, vol. 4, pp. 34–36, Jan. 1992.
- [35] M. Hamacher, H. Heidrich, U. Krüger, R. Stenzel, J. G. Bauer, and H. Albrecht, "Coherent receiver front-end module including a polarization diversity waveguide OIC and a high-speed InGaAs twin-dual p-i-n photodiode OEIC both based on InP," *IEEE Photon. Technol. Lett.*, vol. 4, pp. 1234–1237, Nov. 1992.
- [36] S. Ryu, S. Yamamoto, Y. Namihira, K. Mochizuki, and H. Wakabayashi, "Polarization diversity techniques for the use of coherent optical fiber submarine cable systems," *J. Lightwave Technol.*, vol. 9, pp. 675–682, May 1991.
- [37] G. Ishikawa, Y. Onoda, T. Naito, H. Hamaguchi, and T. Chikama, "Compact, high-performance dual-balanced polarization diversity receiver using quad pin photodiodes and a glass waveguide coupler," in *Proc. 17th ECOC/IOOC*, Paris, France, Sept. 9–12, 1991, paper TuC4-1.
- [38] G. D. Khoe and K. G. Wright, "Integrated microoptic polarization diversity devices for coherent communications systems," in *Proc. 3rd Microoptic Conf., Proc. 3rd MOC*, Yokohama, Japan, Oct. 24–25, 1991, pp. 52–55, paper E1.
- [39] T. Tomioka, M. S. Nakamura, H. Furuyama, M. Onomura, and S. Ohshima, "Balanced polarization diversity with built-in local laser diode," *Electron. Lett.*, vol. 28, no. 19, pp. 1788–1790, 1992.
- [40] E. Hormann, K.-A. Steinhauser, K. Deubel, G. Schmidt-Sodingen, and J. Smola, "Compact optical heterodyne receiver in silicon technology," in *Proc. OFC'92*, San Jose, CA, Feb. 2–7, 1992, paper WG2.
- [41] A. Bruno, L. Giraudet, E. Legros, F. Ghirardi, L. Menigaux, A. Scavennec, and A. Carencio, "3 dB coupler-balanced pin pair JFET circuit integrated on InP for coherent detection," *Electron. Lett.*, vol. 29, no. 22, pp. 1986–1987, 1993.
- [42] D. Trommer, A. Umbach, W. Passenberg, and G. Unterbütsch, "A monolithically integrated balanced mixer OEIC on InP for coherent receiver applications," *IEEE Photon. Technol. Lett.*, vol. 5, pp. 1038–1040, Sept. 1993.

- [43] E. C. M. Pennings, D. Schouten, and G. D. Khoe, "Ultra fabrication-tolerant micro-optical polarization-diversity hybrid," in *Proc. 20th ECOC*, Firenze, Italy, Sept. 25–29, 1994, pp. 217–220.
- [44] E. C. M. Pennings, D. Schouten, R. A. J. C. M. van Gils, G. F. G. Depovere, and G.-D. Khoe, "Fully packaged ultra fabrication-tolerant micro-optical polarization-diversity hybrid," in *Proc. OFC'95*, San Diego, CA, Feb. 26–Mar. 3, 1995, paper TuE3.
- [45] R. Kaiser, F. Fidorra, H. Heidrich, P. Albrecht, W. Rehbein, S. Malchow, H. Schroeter-Janssen, D. Franke, and G. Sztefka, "Integration of tunable DBR-lasers with waveguides for heterodyne receiver OEIC applications using selective area MOVPE," in *Proc. 6th Conf. InP and Related Materials*, Santa Barbara, USA, Mar. 28–31, pp. 476–480.
- [46] E. C. M. Pennings, D. Schouten, G.-D. Khoe, R. A. J. C. M. van Gils, and G. F. G. Depovere, "Ultra fabrication-tolerant fully packaged micro-optical polarization-diversity hybrid," *J. Lightwave Technol.*, vol. 13, pp. 1985–1991, Oct. 1995.
- [47] H. Heidrich, F. Fidorra, M. Hamacher, R. Kaiser, K. Li, D. Trommer, and G. Unterbüsch, in *Proc. 20th ECOC*, Firenze, Italy, Sept. 25–29, 1994, pp. 77–80.
- [48] U. Hilbk, Th. Hermes, P. Meissner, F.-J. Westphal, G. Jacumeit, R. Stenzel, and G. Unterbüsch, "Stable operation of a monolithically integrated InP-heterodyne polarization diversity receiver-module including a tunable laser in an experimental OFDM system," in *Proc. 20th ECOC*, Firenze, Italy, Sept. 25–29, 1994, pp. 75–78.
- [49] E. C. M. Pennings, R. van Roijen, M. J. N. van Stralen, P. J. de Waard, R. G. M. P. Koumans, and B. H. Verbeek, "Reflection properties of multimode interference devices," *IEEE Photon. Technol. Lett.*, vol. 6, pp. 715–718, June 1994.
- [50] L. B. Soldano and E. C. M. Pennings, "Optical multi-mode interference devices based on self-imaging: Principles and applications," *J. Lightwave Technol.*, vol. 13, pp. 615–627, Apr. 1995.
- [51] L. Gillner, E. Berglind, C. P. Larsen, and E. Almström, "Dynamic effects in integrated 4×4 InGaAsP/InP semiconductor optical gate amplifier switch matrices," in *Proc. OAA'95*, Davos, Switzerland, June 15–17, 1995, pp. 111–114.
- [52] B. H. Verbeek, C. H. Henry, N. A. Olsson, K. J. Orlowsky, R. F. Kazarinov, and B. H. Johnson, "Integrated four-channel Mach-Zehnder multi/demultiplexer fabricated with phosphorous doped SiO₂ waveguides on Si," *J. Lightwave Technol.*, vol. 6, pp. 1011–1015, June 1988.
- [53] C. H. Henry, R. F. Kazarinov, Y. Shani, R. C. Kistler, V. Pol, and K. J. Orlowsky, "Four-channel wavelength division multiplexers and bandpass filters based on elliptical Bragg reflectors," *J. Lightwave Technol.*, vol. 8, May pp. 748–755, 1990.
- [54] M. K. Smit, "New focusing and dispersive planar component based on an optical phased array," *Electron. Lett.*, vol. 24, no. 7, pp. 385–386, 1988.
- [55] A. R. Vellekoop and M. K. Smit, "A polarization independent planar wavelength demultiplexer with small dimensions," in *Proc. ECOISA'89*, Amsterdam, The Netherlands, Sept. 25–28, 1989, paper D3.
- [56] A. R. Vellekoop and M. K. Smit, "Four-channel integrated-optic wavelength demultiplexer with weak polarization dependence," *J. Lightwave Technol.*, vol. 9, pp. 310–314, Mar. 1991.
- [57] M. R. Amersfoort, M. K. Smit, Y. S. Oei, B. H. Verbeek, P. Demeester, F. H. Groen, and E. G. Metaal, "Small-size, 4-channel phased-array wavelength division (de)multiplexer on InP," in *Proc. ECOC'93*, Montreux, Switzerland, Sept. 12–16, 1993, pp. 49–52, post-deadline paper.
- [58] C. A. M. Steenbergen, L. C. N. de Vreede, C. van Dam, T. L. M. Scholtes, M. K. Smit, J. L. Tauritz, J. W. Pedersen, I. Moerman, B. H. Verbeek, and R. G. F. Baets, "Integrated 1 GHz 4-channel InP phasor based WDM-receiver with Si bipolar frontend array," in *Proc. ECOC'95*, Brussels, Belgium, Sept. 17–21, 1995, paper Tu.A.3.4.
- [59] H. Takahashi, S. Suzuki, K. Kato, and I. Nishi, "Arrayed-waveguide grating for wavelength division multi/demultiplexer with nanometer resolution," *Electron. Lett.*, vol. 26, no. 2, pp. 87–88, 1990.
- [60] H. Takahashi, S. Suzuki, and I. Nishi, "Multi/demultiplexer for nanometer-spacing WDM using arrayed-waveguide grating," in *Proc. IPR'91*, Monterey, CA, Apr. 9–11, 1991, post-deadline PDI.
- [61] Y. Tachikawa, Y. Inoue, M. Kawachi, H. Takahashi, and K. Inoue, "Arrayed-waveguide grating add-drop multiplexer with loop-back optical paths," *Electron. Lett.*, vol. 29, no. 24, pp. 2133–2134, 1993.
- [62] S. Suzuki, A. Himeno, Y. Tachikawa, and Y. Yamada, "Multichannel optical wavelength selective switch with arrayed-waveguide grating multiplexer," *Electron. Lett.*, vol. 30, no. 13, pp. 1091–1092, 1994.
- [63] C. Dragone, C. A. Edwards, and R. C. Kistler, "Integrated optics $N \times N$ multiplexer on silicon," *IEEE Photon. Technol. Lett.*, vol. 3, pp. 896–899, Oct. 1991.
- [64] M. Zirngibl, C. H. Joyner, L. W. Stulz, Th. Gaiffe, and C. Dragone, "Polarization independent 8×8 waveguide grating multiplexer on InP," *Electron. Lett.*, vol. 29, no. 2, pp. 201–202, 1993.
- [65] M. Zirngibl and C. H. Joyner, "12 frequency WDM laser based on a transmissive waveguide grating router," *Electron. Lett.*, vol. 30, no. 9, pp. 701–702, 1994.
- [66] J. B. D. Soole, A. Scherer, H. P. Leblanc, N. C. Andreadakis, R. Bhat, and M. A. Koza, "Monolithic InP-based grating spectrometer for wavelength-division multiplexed systems at 1.5 micron," *Electron. Lett.*, vol. 27, no. 2, pp. 132–134, 1991.
- [67] J. B. D. Soole, K. Poguntke, A. Scherer, H. P. LeBlanc, C. Chang-Hasnain, J. R. Hayes, C. Caneau, R. Bhat, and M. A. Koza, "Multistripe array grating integrated cavity (magic) laser: A new semiconductor laser for WDM applications," *Electron. Lett.*, vol. 28, no. 19, pp. 1805–1807, 1992.
- [68] J. B. Soole, A. Scherer, Y. Silberberg, H. P. LeBlanc, N. C. Andreadakis, C. Caneau, and K. R. Poguntke, "Integrated grating demultiplexer and pin array for high-density wavelength division multiplexed detection at 1.5 micron," *Electron. Lett.*, vol. 29, no. 6, pp. 558–560, 1993.
- [69] M. R. Amersfoort, J. B. D. Soole, H. P. LeBlanc, N. C. Andreadakis, A. Rajhel, and C. Caneau, " 8×2 nm polarization-independent WDM detector based on compact arrayed waveguide demultiplexer," in *Proc. IPR'95*, Dana Point, CA, Feb. 23–25, 1995, post-deadline paper PD3.
- [70] C. Cremer, G. Ebbinghaus, G. Heise, R. Müller-Nawrath, M. Schienle, and L. Stoll, "Grating spectrograph in InGaAsP/InP for dense wavelength division multiplexing," *Appl. Phys. Lett.*, vol. 59, no. 6, pp. 627–629, 1991.
- [71] C. Cremer, N. Emeis, M. Schier, G. Heise, G. Ebbinghaus, and L. Stoll, "Grating spectrograph integrated with photodiode array in InGaAsP/InGaAs/InP," *IEEE Photon. Technol. Lett.*, vol. 4, pp. 108–110, Jan. 1992.
- [72] C. Cremer, M. Schier, and G. Ebbinghaus, "Monolithically integrated grating receivers for DWDM," in *Proc. ECIO'93*, Neuchatel, Switzerland, Apr. 18–22, 1993, pp. 2–10.
- [73] P. C. Clemens, R. Marz, A. Reichelt, and H. W. Schneider, "Flat-field spectrograph in SiO₂/Si," *IEEE Photon. Technol. Lett.*, vol. 4, pp. 886–887, Aug. 1992.
- [74] J. G. Bauer, G. Baumeister, P. C. Clemens, G. Heise, L. Hoffmann, M. Klein, W. Kunkel, R. Marz, H. Michel, A. Reichelt, M. Schier, and H. W. Schneider, "8-channel DWDM-receiver frontend based on a SiO₂/Si-spectrograph and an InGaAs/InP PIN-photodiode-array," in *Proc. ECOC'94*, Florence, Italy, Sept. 25–29, 1994, pp. 751–754.
- [75] P. C. Clemens, G. Heise, R. Marz, H. Michel, A. Reichelt, and H. W. Schneider, "Optical phased array in SiO₂/Si with adaptable center wavelength," in *Proc. 7th ECIO'95*, Delft, The Netherlands, Apr. 3–6, 1995, pp. 505–508.
- [76] B. H. Verbeek, A. A. M. Staring, E. J. Jansen, R. van Roijen, J. J. M. Binsma, T. van Dongen, M. R. Amersfoort, C. van Dam, and M. K. Smit, "Large bandwidth polarization independent and compact 8 channel PHASAR demultiplexer/filter," in *Proc. OFC'94*, San Jose, CA, Feb. 20–25, 1994, post-deadline paper PDP13.
- [77] H. Bissessur, F. Gaborit, B. Martin, P. Pagnod-Rossiaux, J.-L. Peyre, and M. Renaud, "16 channel phased array wavelength demultiplexer on InP with low polarization sensitivity," *Electron. Lett.*, vol. 30, no. 4, pp. 336–337, 1994.
- [78] H. Bissessur, F. Gaborit, B. Martin, G. Ripoché, and P. Pagnod-Rossiaux, "Tunable phased-array wavelength demultiplexer on InP," *Electron. Lett.*, vol. 31, no. 1, pp. 32–33, 1995.
- [79] M. Gibbon, G. H. B. Thompson, S. J. Clements, D. J. Moule, C. B. Rogers, and C. G. Cureton, "Optical performance of integrated 1.5 micron grating wavelength demultiplexer on InP-based waveguide," *Electron. Lett.*, vol. 25, no. 21, pp. 1441–1442, 1989.
- [80] M. Asghari, B. Zhu, I. H. White, C. P. Seltzer, C. Nice, I. D. Henning, A. L. Burness, and G. H. B. Thompson, "Demonstration of an integrated multichannel grating cavity laser for WDM applications," *Electron. Lett.*, vol. 30, no. 20, pp. 1674–1675, 1994.
- [81] J. P. Lin and S. Thaniyavarn, "Four-channel Ti:LiNbO₃ wavelength division multiplexer for 1.3 micron wavelength operation," *Opt. Lett.*, vol. 16, no. 7, pp. 473–475, 1991.
- [82] S. Ura, M. Morisawa, T. Suhara, and H. Nishihara, "Integrated optic wavelength demultiplexer using a coplanar grating lens," *Appl. Opt.*, vol. 29, no. 9, pp. 1369–1373, 1990.
- [83] H. Uetsuka, K. Akiba, H. Okano, Y. Kurosawa, and K. Morosawa, "Novel $1 \times N$ guided-wave multi/demultiplexer for FDM," in *Proc. OFC'95*, San Diego, CA, Feb. 26–Mar. 3, 1995, paper TuO7.
- [84] M. Seki, K. Kobayashi, Y. Odagiri, M. Shikada, T. Tanigawa, and R. Ishikawa, "20-channel micro-optic grating demultiplexer for 1.1–1.6 micron band using a small focusing parameter graded-index rod lens," *Electron. Lett.*, vol. 18, no. 6, pp. 257–258, 1982.

- [85] D. R. Wisely, "32 channel WDM multiplexer with 1 nm channel spacing and 0.7 nm bandwidth," *Electron. Lett.*, vol. 27, no. 6, pp. 520–521, 1991.
- [86] J. Lipson, W. J. Minford, E. J. Murphy, T. C. Rice, R. A. Linke, and G. T. Harvey, "A six-channel wavelength multiplexer and demultiplexer for single mode systems," *J. Lightwave Technol.*, vol. LT-3, pp. 1159–1162, May 1985.
- [87] B. Moslehi, P. Harvey, J. Ng, and T. Jansson, "Fiber-optic wavelength-division multiplexing and demultiplexing using volume holographic gratings," *Opt. Lett.*, vol. 14, no. 19, pp. 1088–1090, 1989.
- [88] Y. Fujii and J. Minowa, "Four-channel wavelength multiplexing composed of phase plates and polarizing beam splitters," *Appl. Opt.*, vol. 28, no. 7, pp. 1305–1308, 1989.
- [89] J. P. Laude, J. Flamand, J. C. Gautherin, D. Lepere, P. Gacoin, F. Bos, and J. Lerner, "Stimax, a grating multiplexer for monomode or multimode fibers," in *Proc. 9th ECOC'83*, Geneva, Switzerland, Oct. 23–26, 1983, pp. 417–420.
- [90] M. N. McLandrich, R. J. Orazi, and H. R. Marlin, "Polarization independent narrow channel wavelength division multiplexing fiber couplers for 1.55 micron," *J. Lightwave Technol.*, vol. 9, pp. 442–447, Apr. 1991.
- [91] G. P. Agrawal and S. Radic, "Phase-shifted fiber Bragg gratings and their application for wavelength demultiplexing," *IEEE Photon. Technol. Lett.*, vol. 6, pp. 995–997, Aug. 1994.
- [92] L. Eskildsen, E. L. Goldstein, G. K. Chang, M. Z. Iqbal, and C. Lin, "Self-regulating WDM amplifier module for scalable lightwave networks," *IEEE Photon. Technol. Lett.*, vol. 6, pp. 1321–1323, Nov. 1994.
- [93] J. Hegarty, S. D. Poulsen, K. A. Jackson, and I. P. Kaminow, "Low-loss single-mode wavelength-division multiplexing with etched fiber arrays," *Electron. Lett.*, vol. 20, no. 17, pp. 685–686, 1984.
- [94] G. J. Cannell, A. Robertson, and R. Worthington, "Practical realization of a high density diode-coupled wavelength demultiplexer," *IEEE J. Select. Areas Commun.*, vol. 8, no. 6, pp. 1141–1145, 1990.
- [95] K. J. Hood, P. W. Walland, C. L. Nuttall, L. J. St. Ville, T. P. Young, A. Oliphant, R. P. Marsden, J. T. Zubrzycki, G. Cannell, C. Bunney, J. P. Laude, and M. J. Anson, "Optical distribution systems for television studio applications," *J. Lightwave Technol.*, vol. 11, pp. 680–687, May/June 1993.
- [96] M. Shirasaki, "Large angular-dispersion by virtually-imaged phased-array (vipa) and its application to wavelength demultiplexing," in *Proc. MOC'95*, Hiroshima, Japan, Oct. 18–20, 1995, paper PD3.
- [97] E. Gini, M. Blaser, W. Hunziker, and H. Melchior, "Packaged 2.5 Gb/s 4-channel WDM receiver module with InP grating demultiplexer and pin-JFET receiver array," in *Proc. ECOC'95*, Brussels, Belgium, Sept. 17–21, 1995, pp. 207–210.
- [98] K. Okamoto, K. Takiguchi, and Y. Ohmori, "16 ch optical add/drop multiplexer using silica-based arrayed-waveguide gratings," in *Proc. OFC'95*, San Diego, CA, Feb. 26–Mar. 3, 1995, paper PD10.
- [99] O. Ishida, T. Hasegawa, M. Ishii, S. Suzuki, and K. Iwashita, "4 × 4, 7-FDM-channel reconfigurable network hub employing arrayed-waveguide-grating (AWG) multiplexers," in *Proc. OFC'95*, San Diego, CA, Feb. 26–Mar. 3, 1995, paper PD9.
- [100] B. R. Hemenway, M. L. Stevens, D. M. Castagnozzi, D. Marquis, S. A. Parikh, J. J. Carney, S. G. Finn, and E. A. Swanson, "A 20-channel wavelength-routed all-optical network deployed in the Boston metro area," in *Proc. OFC'95*, San Diego, CA, Feb. 26–Mar. 3, 1995, paper PD8.
- [101] K. Oda, M. Fukui, M. Fukutoku, A. Umeda, T. Kitoh, and H. Toba, "10 channel × 10 Gb/s over 500 km optical FDM-add/drop multiplexing experiment employing a 16-channel arrayed-waveguide-grating ADM filter," in *Proc. ECOC'95*, Brussels, Belgium, Sept. 17–21, 1995, pp. 59–62.
- [102] L. H. Spiekman, A. A. M. Staring, C. van Dam, E. J. Jansen, J. J. M. Binsma, M. K. Smit, and B. H. Verbeek, "Space-switching using wavelength conversion at 2.5 Gb/s and integrated phased array routing," in *Proc. ECOC'95*, Brussels, Belgium, Sept. 17–21, 1995, pp. 1055–1058.
- [103] M. Miyachi, M. Ogusu, and S. Ohshima, "Cross-talk penalty-free dense WDM system with a Littrow-mounted optical wavelength mux.," in *Proc. ECOC'95*, Brussels, Belgium, Sept. 17–21, 1995, pp. 67–70.
- [104] M. A. Scobey and P. Stupik, "Improved temperature and humidity stability of ultra-narrow band filters," in *Soc. Vacuum Coaters 37th Annu. Tech. Conf. Proc.*, Boston, May 8–13, pp. 47–52.
- [105] A. A. M. Staring, L. H. Spiekman, J. J. M. Binsma, E. J. Jansen, T. van Dongen, P. J. A. Thijs, M. K. Smit, and B. H. Verbeek, "A compact nine-channel multiwavelength laser," *IEEE Photon. Technol. Lett.*, vol. 8, pp. 1139–1141, Sept. 1996.



Erik Pennings (S'88–M'90) was born in Sassenheim, The Netherlands, on November 3, 1960. He received the M.Sc. degree (*cum laude*) in applied physics from Groningen University in 1986, and the Ph.D. degree in electrical engineering from Delft University of Technology, The Netherlands, in 1990.

His thesis describes modeling and experiments on bends in optical waveguides and on multimode interference couplers. He subsequently joined Bell Communications Research in Red Bank, NJ, as a Post-Doctoral Member of Technical Staff, where he worked on InP-based photonic integrated circuits. In 1992, he joined the group Wideband Communication Systems of Philips Research Laboratories, Eindhoven, The Netherlands, where he developed micro-optical components for high bit rate optical communication systems. From 1994 to 1995, he participated in a multimedia strategy project located in Redhill, U.K. In 1995, he joined Philips Optoelectronics, Eindhoven, The Netherlands, where his responsibilities include the business development of advanced components such as tunable lasers, semiconductor optical amplifiers, high-speed lasers and WDM components. He has written and coauthored over fifty scientific papers and conference contributions, six invited papers, and holds several patents. Dr. Pennings is a member of the OSA and recently initiated the formation of an IEEE/LEOS chapter for the Benelux.



Giok-Djan Khoe (S'71–M'71–SM'85–F'91) was born in Magelang, Indonesia, on July 22, 1946. He received the degree of Elektrotechnisch Ingenieur (*cum laude*) from the Eindhoven University of Technology, Eindhoven, The Netherlands, in 1971.

He worked at the FOM Institute of Plasma Physics, Rijnhuizen, The Netherlands, on laser diagnostics of plasmas from 1971 to 1972. In 1973, he joined the Philips Research Laboratories and in addition, he was appointed as part time professor at the Eindhoven University of Technology since 1983. He became a full Professor at the same University in 1994 and is currently chairman of the Department of Telecommunication Technology and Electromagnetism. His work has been devoted to single-mode fiber systems and components. He has more than 40 U.S. patents, and has authored and coauthored more than 70 papers, invited papers and books.

Dr. Khoe's professional activities include many conferences, where he has served in technical committees, management committees and advisory committees as a member or chairman. He has numerous involvements in journal activities, as associate editor or as member of the advisory board. In Europe, he is closely involved in Community Research Programs and Dutch national research programs, as participant, evaluator, auditor and program committee member. He is one of the founders of the Dutch COBRA University Research Institute, and is currently a member of the board. He was European Representative at the IEEE/LEOS Board of Governors, is currently VP of Membership & Region 8 Activities and is member of the Executive Section Committee of the IEEE Benelux Section.

Meint K. Smit, for photograph and biography, see this issue, p. 150.



Toine Staring was born in Tilburg, The Netherlands, on October 9, 1964. He received the M.Sc. and Ph.D. degrees in engineering physics from the Eindhoven University of Technology, Eindhoven, The Netherlands, in 1988 and 1992, respectively.

He joined the Philips Research Laboratories in 1990, continuing his work on electrical transport in zero- and one-dimensional semiconductor structures. In 1993, he moved to the Philips Optoelectronics Centre, where his current research interests mainly are in the field of tunable DBR lasers, and integrated-optic components for WDM applications.