

## Resource allocation in optical beam-steered indoor networks

**Citation for published version (APA):**

Torres Vega, M., Famaey, J., Koonen, A. M. J., & Liotta, A. (2016). Resource allocation in optical beam-steered indoor networks. In *IEEE/IFIP Network Operations and Management Symposium (NOMS 2016), 25-29 April 2016, Istanbul, Turkey* (pp. 418-426). Institute of Electrical and Electronics Engineers.  
<https://doi.org/10.1109/NOMS.2016.7502839>

**DOI:**

[10.1109/NOMS.2016.7502839](https://doi.org/10.1109/NOMS.2016.7502839)

**Document status and date:**

Published: 04/07/2016

**Document Version:**

Accepted manuscript including changes made at the peer-review stage

**Please check the document version of this publication:**

- A submitted manuscript is the version of the article upon submission and before peer-review. There can be important differences between the submitted version and the official published version of record. People interested in the research are advised to contact the author for the final version of the publication, or visit the DOI to the publisher's website.
- The final author version and the galley proof are versions of the publication after peer review.
- The final published version features the final layout of the paper including the volume, issue and page numbers.

[Link to publication](#)

**General rights**

Copyright and moral rights for the publications made accessible in the public portal are retained by the authors and/or other copyright owners and it is a condition of accessing publications that users recognise and abide by the legal requirements associated with these rights.

- Users may download and print one copy of any publication from the public portal for the purpose of private study or research.
- You may not further distribute the material or use it for any profit-making activity or commercial gain
- You may freely distribute the URL identifying the publication in the public portal.

If the publication is distributed under the terms of Article 25fa of the Dutch Copyright Act, indicated by the "Taverne" license above, please follow below link for the End User Agreement:

[www.tue.nl/taverne](http://www.tue.nl/taverne)

**Take down policy**

If you believe that this document breaches copyright please contact us at:

[openaccess@tue.nl](mailto:openaccess@tue.nl)

providing details and we will investigate your claim.

# Resource Allocation in Optical Beam-Steered Indoor Networks

Maria Torres Vega\*, Jeroen Famaey†, A.M.J. Koonen\*, Antonio Liotta\*

\* Eindhoven University of Technology

Email: m.torres.vega, a.m.j.koonen, a.liotta@tue.nl

† University of Antwerp-iMinds

Email : jeroen.famaey@uantwerpen.be

**Abstract**—Optical Wireless (OW) technologies deploying narrow multiwavelength light beams offer a promising alternative to traditional wireless indoor communications as they provide higher bandwidths and overcome the radio spectrum congestion typical of the 2.4 and 5GHz frequency bands. However, unlocking their full potential requires exploring novel control and management techniques. Specifically, there is a need for efficient and intelligent resource management and localization techniques that allot wavelengths and capacity to devices. In this paper we present a resource allocation model for one such indoor optical wireless approach, a Beam-steered Reconfigurable Optical-Wireless System for Energy-efficient communication (BROWSE). BROWSE aims to supply each user within a room with its own downstream infrared light beam with at least 10Gbps throughput, while providing a 60GHz radio channel upstream. Using Integer Linear Programming (ILP) techniques, we have designed and implemented a resource allocation model for the BROWSE OW downstream connection. The designed model optimises the trade-off between energy-consumption and throughput, while providing TDM capabilities to effectively serve densely deployed devices with a limited number of simultaneous available wavelengths. Through several test-scenarios we have assessed the model's performance, as well as its applicability to future ultra-high bandwidth video streaming applications.

**Index Terms**—Resource allocation, Wireless Optics, Beam steering, ILP models.

## I. INTRODUCTION

The world of communications is evolving towards an era of interconnectivity, where everyone and everything is connected [1]. This is often referred to as the Internet of Things (IoT) vision, which predicts that by 2020 between 50 and 100 billion devices will be wirelessly connected to the Internet [2] [3]. These devices bring with them their own protocols and management architectures which need to be transported over the wireless network [4]. At the same time, applications do not cease to increase in complexity and bandwidth requirements. In fact, multimedia services have seen an exponential growth [5] not only in number but in terms of variety of requirements [6], [7]. This evolution, which has taken only a few years, has gone from a few hundred kilobits per second quality videos to the current high

definition (roughly 8Mbps). Furthermore, new standards such as 4K, 8K or UDHTV1 will be requiring transmissions speed in the order of gigabits per second for a single video [8]. These services have traditionally been delivered by standard wireless radio technologies such as IEEE 802.11. However, due to the increase of devices and bandwidth needs, the already congested radio spectrum is struggling to fulfill the users' requirements [9] and novel transmission techniques are being developed. Thus, the current challenges of these novel techniques come in the form of congestion avoidance and ultra-high bandwidths, in the context of high-density wireless communications.

One such approach is the Beam-steered Reconfigurable Optical-Wireless System for Energy-efficient communication (BROWSE) [1]. BROWSE proposes a hybrid system providing services by means of narrowly confined optical light beams accurately directed to the devices, achieving interference-free ultra-high data rates (a minimum of 10Gbps per beam [10]) for the downstream; combined with a shared 60GHz radio channel for the upstream. BROWSE shows several characteristics not present in existing wireless LAN technologies, including hybrid optical-radio communications, a limited number of simultaneous beams and the need to accurately align beams to devices. Consequently, there is a need for novel intelligent control and management solutions that can cope with these characteristics [11], while satisfying the BROWSE performance and energy requirements. Especially critical are the resource allocation tasks of the optical wireless downstream connections. Deciding which beam, when and with how much energy needs to be connected to which device in order to maximize system performance and minimize energy consumption poses a great challenge to the resource optimisation component.

In this paper, we present an optimization model that can address the stringent requirements of a wireless optical system, using the BROWSE framework as case study. Making use of Integer Linear Programming (ILP) techniques, we have developed a theoretical formulation of the communications in the BROWSE system. With this model we tackle the challenges of distributing service to all the devices in an energy efficient way. Furthermore, we solve the resource allocation problem in congested environments due to densely populated and limited resources situations (i.e. limited number of si-

### Pre-printed version.

Please cite as: M. Torres Vega, J. Famaey, A. M. J. Koonen and A. Liotta: Resource Allocation in Optical Beam-Steered Indoor Networks. in proc. of the IEEE/IFIP Network Operations and Management Symposium (NOMS2016), 25-29 April 2016, Istanbul (Turkey).

multaneous beams) by means of time-division multiplexing (TDM). Through varied test-scenarios we have assessed the performance-energy trade-off in the BROWSE system, as well as its applicability to future ultra-high bandwidth multimedia applications.

The remainder of this paper is organized as follows. Section II gives a short overview on the state-of-the-art of optical wireless technologies, the techniques for resource management currently used and how they are compared to the BROWSE system. Section III provides a description of the basic functionality of the envisioned management system of BROWSE. The ILP formulation is provided in Section IV. Section V describes how the BROWSE system is organized and provides rules to correctly dimensioning a room. Section VI describes and discusses the evaluation results. Finally, some conclusions and directions for future work are summarized in Section VII.

## II. RELATED WORK

Reducing network congestion and interference while achieving ultra-high capacity are major challenges in wireless transmissions. Cognitive Radio and Software Defined Radio intend to solve these challenges within the current radio spectrum. These techniques propose to dynamically select available radio channels to perform congestion-free transmission. Examples of these are the Quality of Service analysis approach of Ishibashi et al. [12] or the more recent Heterogeneous Cloud Radio Access Networks resource sharing technique by Marotta et al. [13]. However, although efficiently dealing with the congestion, intelligent approaches in the radio part of the electromagnetic spectrum fail to provide the interference free and ultra-high speeds communication that the future services and users will require. In the quest to surmount these constrains, time has come to seriously consider the upper parts of the electromagnetic spectrum, i.e. Optical Wireless technologies (OWs) [14].

Characteristics such as virtually unlimited available bandwidth, inherent security and limited interference with domestic appliance and conventional radio communications [9], make OWs the perfect candidate for future wireless communications. Quite some research has already been done in Visual Light Communication (VLC) [15], where LED lighting is used both for ambient illumination and communication. However, the non-directivity of the LED-light and the big area to be covered (usually a whole room) cause a limited bandwidth per user due to sharing as well as interference [1]. Thus, the current challenges in OW technologies for indoor communications come in the form of ultra-high capacity and interference free transmission.

The BROWSE [1] approach proposes a system which provides ultra-high capacity (transmissions of 42.8Gbps per link have been demonstrated in [16]) and interference free transmission. Inside a BROWSE building, the rooms are equipped with pencil radiating antennas (PRAs), each one able to emit multiple optical infrared (in the  $1.5\mu\text{m}$  range) pencil beams simultaneously. In addition, a shared 60GHz radio channel is proposed to cover the upstream needs as well as the task

to localize the users. The BROWSE concept does not suffer from interference, but instead requires a clear line of sight, which may result in degradations due to obstacles and user mobility. In addition, it needs high precision user's localization (in the order of a centimeter), which, to our knowledge has not been achieved yet (algorithms using triangulation [17] or fingerprinting [18] techniques have reported localization accuracy in the order of decimeter). These characteristics, as well as the extremely high achievable throughput, make BROWSE differ significantly from traditional wireless LAN technologies, therefore calling for novel control and management mechanisms in order to unlock its full potential.

Especially critical is the task of allocating the resources, which will vary depending on the network under study. Extensive research has been performed on resource allocation in optical networks. However, in the field of fibre optics the focus of attention has mostly been on how to allocate resources in optical transport networks. Such are the cases of the scalable dimensioning approach of Thysebaert et al. [19] or the Virtualization algorithm of Vilalta et al. [20]. On the topic of indoor infrared OW resource management, already in 1996 Marsh et al. [21] studied the use of traditional radio channel reuse techniques, such as TDMA and CDMA, for indoor optical infrared communications. Further on, Dimitrov et al. [22] discussed the importance of the Signal-to-Interference (SIR) ratio while dealing with indoor infrared optics. Based on these results, Ghimire et al. [23] presented an algorithm for indoor infrared light networks. These cases focus their effort on solving the interference problem among channels and users. Furthermore, diffuse light, absence of obstacles and user localization were assumed. In contrast, allocating resources for the beam-steered technique of BROWSE requires selecting the beam which provides perfect user-beam alignment, obstacle detection, ultra-high capacity control and optimal integration with the 60GHz radio uplink. Furthermore, energy consumption and optimal management of the limited resources (i.e. the number of possible simultaneous beams) are key factors to solve in our resource allocation model.

## III. THE BROWSE SYSTEM MANAGEMENT

Inside a BROWSE building (Figure 1) each room has one or more PRAs installed on the ceiling. These PRAs are capable of providing each of the users connected to it with an ultra-high bandwidth downlink (10Gbps is expected, 42.8Gbps transmissions have been demonstrated in [16]). For the uplink, these PRAs provide a shared 60GHz radio channel. Radio beam forming by using phased array antennas is foreseen to create multiple spatial channels within the same frequency band. In addition to the tasks of the uplink data transport, the radio channel takes charge of the user's localization. The system management is centralized in the CCC (Central Communication Controller) located on the side of the building. Its purpose is to manage and control the communications of the rest of the system in a fast and optimized manner so that neither the incoming users nor the devices already in the room suffer any noticeable disturbance on their communication.

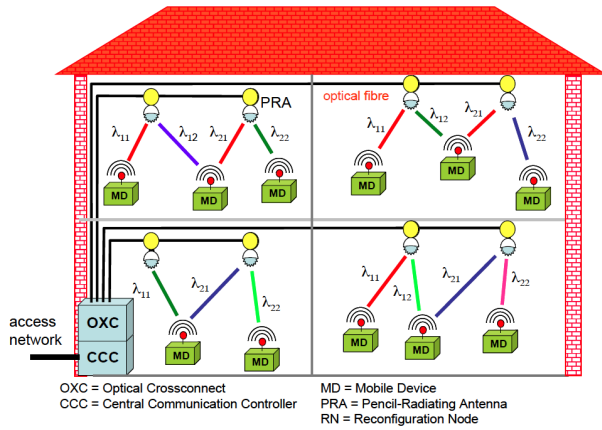

Fig. 1: BROWSE building.

Figure 2 shows a flow diagram of the BROWSE's system management. On entering the room, the user is firstly detected. This can be done by means of a wake up signal from the user's receiver or by active search of the PRAs. Then, it tries to estimate its position. The localization is performed by the radio subsystem and it needs to provide a real time accuracy in the order of a centimeter (the diameter of the beams steered as downstream is foreseen to be about 3cm). A strong localization algorithm in combination with machine learning, and specifically online learning techniques, can be used to speed up the process and output more accurate positions.

The localization information is used to allocate the new user's resources. Both the radio slot and optical wireless beam are allocated in parallel according to the user's location, its initial requirements (i.e. bandwidth needs) and, the current load in the system. Allocating the optical beam means to first assing the PRA and beam that better fulfill the user's bandwidth requirements for the estimated position. Further on, the beam is steered to the accurate position of the user and the power is tuned according to the bandwidth requirements of the user (higher bandwidth needs higher power). These bandwidth requirements can be extracted from the user's behavioural patterns and further tuned by online learning techniques in the quality monitoring phase. When the connection is established, the quality starts to be monitored. Physical layer parameters such as bit error rates (BER), Signal to Noise Ratio (SNR) or the received power, network parameters, such as packet loss and bitrate, and application parameters, such as the feedback from the user, are monitored and carefully studied in order to discover service degradations. In this way, low degradations (service failures) will be tackled by means of tuning the beam both in location (steering to a most accurate position) and strength (changes on the power provided). Furthermore, if the service degrades in a great manner, it can mean two things: (1) the beam is blocked, (2) the receiver has moved. In the first case the system needs to select a new beam and PRA, which avoid the blocking and are well suited to the user's position.

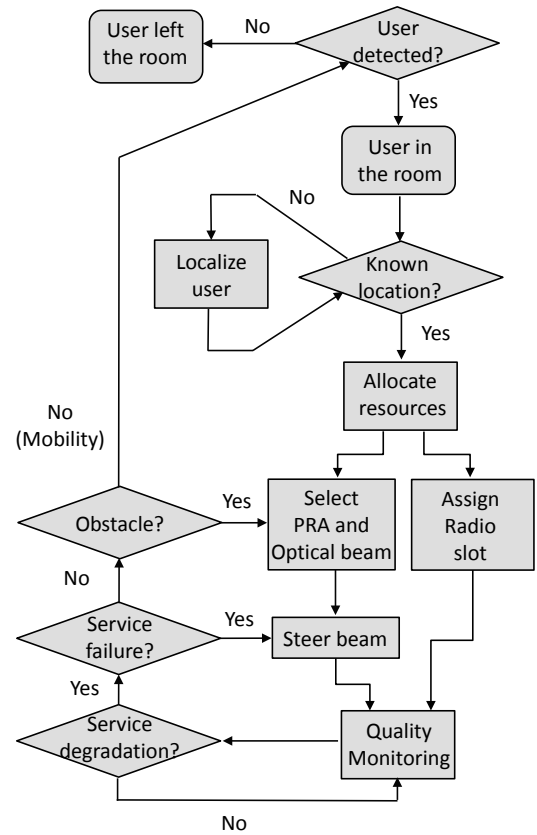

Fig. 2: BROWSE management flow chart.

In the second case, the system will trigger a new search for the user's current location. Obstacles or mobility detection and handover are very sensitive tasks that have to be performed fast enough such that the user does not experience a flaw in its service. Different protocols and services require their own distinct transmission conditions. For example, serving a skype call will require more exhaustive monitoring and faster proaction time than an FTP transmission, in which the change-over between beams would not bring a strong effect on the users.

#### IV. BROWSE BEAM-STEERED RESOURCE ALLOCATION MODEL

When a device has been localized within the room and its service needs have been identified, the resource allocation algorithm assigns a beam that fits both its position and requirements. Allocating resources in such a system requires two actions. First, the system needs to decide which beam and bandwidth to provide to the user while ensuring the desired service quality and energy efficiency. Second, it needs to be able to service users even in densely populated environments. In these situations, a TDM approach offers the possibility to split the service to multiple devices within a single interval, i.e. an optical beam can be switched fast among a number of devices, and serve each of them subsequently within that interval. With these two purposes in mind, in this section we present the resource allocation model for the BROWSE

TABLE I: Symbols and notations used in the resource allocation model.

Variable	Description
$\tau_s$	Simulation duration in milliseconds
$\tau_q$	Quality assessment period in milliseconds
$\tau_c$	TDM cycle in milliseconds
$N_{TDM}$	TDM factor, number of TDM cycles ( $\tau_c$ ) in a Quality assessment period ( $\tau_q$ )
$\mathcal{T}_c$	set of time intervals ranging from 0 to $\frac{\tau_s}{\tau_c}$
$\mathcal{T}_q$	set of time intervals ranging from 0 to $\frac{\tau_s}{\tau_q}$
$\mathcal{P}$	Set of PRAs in one room
$loc_p$	Location of PRA p
$\mathcal{D}$	Set of devices in one room
$\mathcal{B}_p$	Set of beams assigned to PRA p
$loc_b$	location of beam b assigned to PRA p
$\epsilon_b$	Maximum power possible for beam b
$\mathcal{E}_p$	energy consumed by PRA p when powered up
$\lambda_r$	maximum number of beams available
$\rho_d$	minimum bandwidth required by device d
$Q_d(r_{t,b,d}, loc_p, loc_b)$	Quality function for device d
$e_{t,b,d}$	Real decision variable between 0 and $\epsilon_b$ ; Power intensity delivered by PRA p to device d in time interval t
$c_{t,b,d}$	Binary decision variable; Device d is connected to beam b $\in \mathcal{B}_p$ in t
$s_{t,p}$	Binary decision variable (1-Active, 0-Idle); Status of PRA p in interval t

downstream. Section IV-A introduces the variables used to determine the optimal allocation decision. Then, the objective function is described in Section IV-B. Finally, we define the set of constraints managing our BROWSE model (Section IV-C). Table I shows a list of the variables and constants used for the formal model definition.

#### A. Decision Variables

Our model relies on three decision variables. First,  $e_{t,b,d}$  (Equation 1) represents the power intensity delivered by beam  $b \in \mathcal{B}_p$  to device  $d$ . Second,  $c_{t,b,d}$  (Equation 2) is set to 1 if beam  $b \in \mathcal{B}_p$  provides service to device  $d \in \mathcal{D}$ . Finally, the status of PRA  $p$  during time interval  $t$  is decided by means of the binary variable  $s_{t,p}$  (Equation 3). If set to 1, the PRA is in active mode. Otherwise, it is in sleep mode (low consumption mode).

$$e_{t,b,d} \in [0, \epsilon_b] \quad (1)$$

$$c_{t,b,d} = \{0, 1\} \quad (2)$$

$$s_{t,p} = \{0, 1\} \quad (3)$$

#### B. Objective function

The BROWSE resource allocation model fulfills two objectives. First, reducing energy consumption to its optimal minimum is fundamental. The concept and technicalities of the system energy efficiency objectives will be discussed in Section IV-B1. Second, it needs to maximize the service quality experienced by each user per device and application (Section IV-B2). These two objectives have to be combined into a function which will be the one to be optimized for solving the allocation model (section IV-B3).

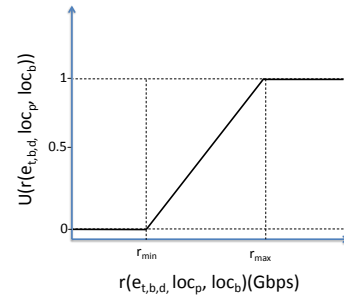

Fig. 3: Bitrate utility function.

1) *Energy consumption*: BROWSE's energy consumption is linearly dependent on the number of PRAs, beams and power per beam used to connect to the devices. In addition, the PRAs consume an extra residual energy when they are active, i.e. providing service to at least one device ( $\mathcal{E}_p$ ).

$$EO = \sum_{t_c \in \mathcal{T}_c} \sum_{p \in \mathcal{P}} (s_{t_c,p} * \mathcal{E}_p + \sum_{b \in \mathcal{B}_p} \sum_{d \in \mathcal{D}} e_{t_c,b,d}) \quad (4)$$

Equation 4 shows the system's energy consumed. We minimize the energy consumption by reducing the number of active PRAs in each time interval as well as the power consumed by each connected beam.

2) *User's quality*: Quality can be defined through different Quality of Service (QoS) attributes and parameters depending on the type of application which is being analysed [24]. Delays, expected responses and bandwidth have been considered among the parameters which determine the quality received by the user. Given the fact that the system at hand provides interference-free communication and speed of light transmission, we have considered that the service quality mainly depends on the bandwidth provided by the beam to the user ( $r_{t,b,d}$ ). The delivered bitrate depends on the energy provided to the device,  $e_{t,d,p}$ , as well as the location of the PRA ( $loc_p$ ) and that of the beam in use ( $loc_b$ ).

The experienced service quality increases with the bitrate, however, depending on the application's requirements, it will saturate after the point in which the devices have their bitrate requirements fulfilled. For this reason, we define a Utility function  $U$  (in range  $[0,1]$ ) representing the dependence of service quality versus the received bitrate [25]. Figure 3 shows the utility function of the quality-bitrate where  $r_{d,min}$  is the minimum bitrate required by the device in order for the quality to be at threshold ( $=0$ ) and  $r_{d,max}$  is the maximum needed bitrate by the device to achieve full quality ( $=1$ ).

$$Q_d(r(e_{t,d,p}, loc_p, loc_b)) = U(r(e_{t,b,d}, loc_p, loc_b)) \quad (5)$$

Finally, the quality function consists of maximizing the service experienced quality for each quality assessment period (period of time used to assess the served quality, which is typically set to 1 second due to the fact that the bitrate is analyzed in Gigabits per second), for all devices (Equation 6). As already introduced, in this model we use TDM techniques

in order to avoid over-provisioning and serving the maximum number of devices possible per time interval. This is done by means of the relation between the quality assessment period  $\tau_q$  and the TDM cycle duration  $\tau_c$  (the minimum operation time slot). The ratio between these two values is called TDM factor ( $N_{TDM}$ ) and determines the granularity of the TDM scheme. Thus, the quality is calculated fit to the bitrate provided to the user in the whole quality assessment period, i.e. as the averaged sum of the bitrates supplied in each of the TDM cycles within the quality period.

$$QO = \sum_{t_q \in \mathcal{T}_q} \sum_{d \in \mathcal{D}} Q_d \left( \sum_{p \in \mathcal{P}} \sum_{b \in \mathcal{B}_p} \sum_{t_c = t_q * N_{TDM}}^{(t_q+1) * N_{TDM} - 1} \frac{1}{N_{TDM}} * r(e_{t_c, d, p}, loc_p, loc_b) \right) \quad (6)$$

3) *Combined objective function*: Our model's objective is a linear combination of the energy and the quality components (Equation 7). The constant  $\alpha$  determines the weight of each of the objectives.

$$\max(\alpha * QO - (1 - \alpha) * EO) \quad (7)$$

### C. General Constraints

The BROWSE system is limited by the following constraints.

- 1) *Unique provisioning*: For each TDM cycle interval  $t_c$ , device  $d$  can only be served by 1 beam (Equation 8) and each beam can only serve one device (Equation 9).

$$\forall t_c \in \mathcal{T}_c, \forall d \in \mathcal{D} : \sum_{p \in \mathcal{P}} \sum_{b \in \mathcal{B}_p} c_{t_c, b, d} \leq 1 \quad (8)$$

$$\forall t_c \in \mathcal{T}_c, \forall p \in \mathcal{P}, \forall b \in \mathcal{B}_p : \sum_{d \in \mathcal{D}} c_{t_c, b, d} \leq 1 \quad (9)$$

- 2) *PRA energy policy*: For each TDM cycle interval  $t_c$ , if PRA  $p$  is providing service to at least one device, then it is set to active mode (Equation 10). Otherwise it is in sleep mode (low power consumption mode).

$$\forall t_c \in \mathcal{T}_c, \forall p \in \mathcal{P}, \forall b \in \mathcal{B}_p : \sum_{d \in \mathcal{D}} c_{t_c, b, d} \leq s_{t_c, p} * |\mathcal{D}| \quad (10)$$

- 3) *Connectivity*: For each TDM cycle interval  $t_c$ , if a PRA  $p$  that is not providing energy to a device  $d$ , it cannot be connected to it.

$$\forall t_c \in \mathcal{T}_c, \forall p \in \mathcal{P}, \forall b \in \mathcal{B}_p, \forall d \in \mathcal{D} : e_{t_c, b, d} \leq c_{t_c, b, d} * \epsilon_b \quad (11)$$

- 4) *Limited resources*: For each TDM cycle interval  $t_c$ , the maximum of concurrent beams is limited by the maximum number of available wavelengths.

$$\forall t_c \in \mathcal{T}_c : \sum_{p \in \mathcal{P}} \sum_{b \in \mathcal{B}_p} \sum_{d \in \mathcal{D}} c_{t_c, b, d} \leq \lambda_r \quad (12)$$

- 5) *Minimum bandwidth*: For each quality assessment interval  $t_q$ , device  $d$  requires to be served by a bandwidth of at least  $\rho_d$  (Equation 13).

$$\forall t_q \in \mathcal{T}_q, \forall d \in \mathcal{D} :$$

$$\sum_{p \in \mathcal{P}} \sum_{b \in \mathcal{B}_p} \sum_{t_c = t_q * \frac{\tau_q}{\tau_c}}^{(t_q+1) * \frac{\tau_q}{\tau_c} - 1} \frac{\tau_c}{\tau_q} * r(e_{t_c, d, p}, loc_p, loc_b) \geq \rho_d \quad (13)$$

## V. DIMENSIONING THE BROWSE ROOM

In an average BROWSE room of dimensions  $D \times D \times H$ ,  $N$  PRAs are uniformly installed within the whole area. Each PRA covers an area of  $L \times L \times H$  (Figure 4) ( $L = D / \sqrt{N}$ ) by means of a 2-dimensional beam scanning mechanism [26].

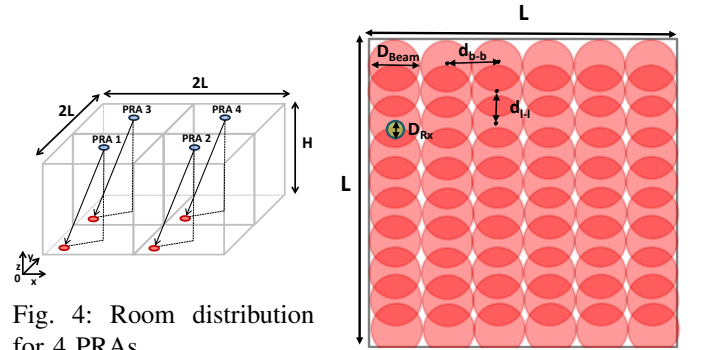

Fig. 4: Room distribution for 4 PRAs.

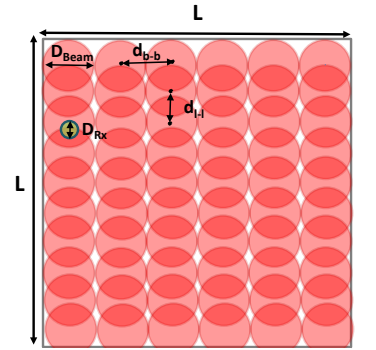

Fig. 5: Beam distribution on the PRA surface.

Dimensioning the PRA area with the purpose of maximizing its coverage (i.e. reducing the number of blind spots or spots not covered by any beam) means to set four parameters (Figure 5). However, this selection has to be done in such a way that we avoid stressing the physical limitations of the system. First of all, the diameter of the scanning beam ( $D_{beam}$ ) determines the area covered by each of the beams. Choosing a very small diameter value would lead to infinite scanning steps both in the horizontal and vertical lines, becoming infeasible to achieve with the current technology, as well as delaying substantially the scanning and selection procedure. A value between  $10mm$  and  $10cm$  is acceptable for this parameter. Second,  $d_{b-b}$  is the in-line distance between the beams. The more beams the PRA sets in a line the less blind spots in the area. This value is limited not only by the commercially available devices but also by the diameter of the beam. Setting this distance to the diameter of the beam provides close to full coverage of the horizontal line. Third,  $d_{l-l}$  is the vertical distance between scanning lines. A value of at most the beam diameter will reduce the blind spots in the service area. Finally, the receptor diameter ( $D_{Rx}$ ) has to be selected. Knowing the maximum bitrate that the system should provide per user, the receiver sensitivity ( $P_{Rx}$ ), i.e. the minimum power needed to achieve the bitrate, is obtained from the curve of sensitivities and bitrates depicted (Figure 6). This curve has been obtained based on the sensitivity-bitrate coupled-values

of commercially available optical systems [27] [28] [29]. From there, the  $D_{Rx}$  can be derived using the Equation 14.

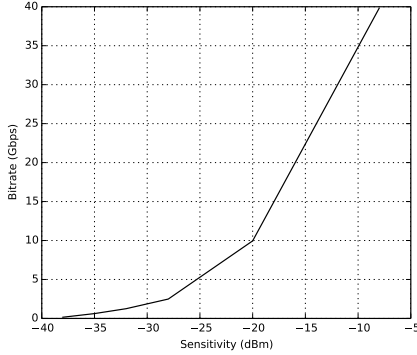

Fig. 6: Bitrate vs receiver sensitivity.

$$D_{Rx} = \sqrt{\frac{P_{Rx}}{P_{Beam}} * \frac{1}{D_{Beam}^2} * (1 + \frac{(x_p - x_b)^2 + (y_p - y_b)^2}{H^2})} \quad (14)$$

In it,  $x_p$ ,  $y_p$  and  $x_b$ ,  $y_b$  are the x, y coordinates of the PRA and the projected beam respectively.  $P_{Beam}$  is the maximum power that the beam can provide, which is stated by the ANZI-136 and international IEC 60825 to 10mW. Further details on the dimensioning of the room can be found in [26].

## VI. RESULTS AND DISCUSSION

This section first presents the simulation setup (Section VI-A). Then, the experiments performed and their results are to be found in Section VI-B.

### A. Simulation setup

We dimensioned a room of  $3 \times 3 \times 2.5 \text{ m}^3$ . 4 PRAs are uniformly distributed in it, each one of them covering an area of  $1.5 \times 1.5 \times 2.5 \text{ m}^3$ . The beam diameter  $D_{beam}$  is set to 3cm (according to [26]). In the horizontal line ( $d_{b-b}$ ), the beams are spaced by their diameter (3cm). In the vertical line,  $d_{l-l}$ , they are separated by the beam radius,  $D_{beam}/2$ , 1.5cm. Finally, as each beam is to provide a maximum of 10Gbps per user (which corresponds to  $-20\text{dBm}$ , i.e. 0.01mW), the receivers' diameter is set to 1mm (according to [26]).

In the near future some applications will require an ultra-high bandwidth (1Gbps and more). For example, 8K, in some of its forms (for example  $3840 \times 2160$  pixels, 120fps), requires bandwidths of up to 500Mbps per video or UHDTV1 and 3D-Stereoscopic videos expect transmissions of 1Gbps and 10Gbps [8], respectively. In addition, lower bandwidth services, such as high quality browsing, HD and SD video streaming or video conferencing, will still be in use and co-exist with the ultra-high bandwidth ones. Thus, we defined three device categories according to the user's bandwidth demands: High bandwidth (HB), low bandwidth (LB) and best effort (BE) (Table II). We set the high and low bandwidth limits according to the predicted bandwidth requirements of future multimedia services. In this way, a HB-user would

want to receive UHDTV1 video streamings, which requires at least 6Gbps per ultra high quality video transmission [30] and a minimum of 1Gbps for low quality transmission. The LB-user would require 1Gbps, i.e. lower quality UHDTV1 or 8K and in its default, HD video streaming, high quality browsing and conferencing [31]. Finally the BE-user would be provided a maximum bandwidth of 0.1Gbps (equivalent to HD video streamings, browsing and conferencing) and a minimum of 5Mbps, which is the value typically assigned to browsing and low quality traffic [31]. It is important to notice that these bitrates cannot be achieved with the current state-of-the-art WiFi technologies. The new standard 802.11ac reports a theoretical throughput of close to 7Gbps [32]. However, in practice only a bandwidth of at maximum 600Mbps has been achieved [33] [34].

TABLE II: User categories.

Category	Bandwidth Limit Low (Gbps) ( $r_{d,min}$ )	Bandwidth Limit High (Gbps) ( $r_{d,max}$ )
HB	1	10
LB	0.1	1
BE	0.005	0.1

### B. Experiments

For the purpose of these experiments, we have designed 6 use cases in which number of devices and user requirements change (Table III). Each of the cases is either 40 or 10 devices and follows one category type (All HB, All LB and HB, LB & BE). The devices are uniformly located in the room and are fixed in location during the simulation.

TABLE III: Case studies.

Type	Dev.	HB	LB	BE
All	10	10	0	0
HB	40	40	0	0
All	10	0	10	0
LB	40	0	40	0
HB, LB & BE	10	3	3	4
	40	13	13	14

TABLE IV: Constant values used for the experiments.

	Exp.1	Exp.2
$\tau_c$	100ms	10ms - 1s
$\tau_s$	1000ms	1000ms
$\tau_q$	1000ms	1000ms
$N_{TDM}$	10	1, 2, 10, 100
$\epsilon_p$	10mW	10mW
$\mathcal{E}_p$	0.1mW	0.1mW
$\lambda_r$	40	1 - 40
$\alpha$	0 - 1	0.8
$\rho_d$	$r_{d,min}$	0

1) *Exp. 1-Energy and Quality*: The purpose of this first experiment is to understand the trade-off between energy and quality optimization by means of the  $\alpha$  constant. Moreover, we aim to understand how this relation is affected by the changing conditions of the users of the room.

Table IV column Exp. 1 shows the configured parameters for this evaluation. The quality assessment period  $\tau_q$  is set to 1000ms as our quality is measured in Gigabits per second. The TDM factor  $N_{TDM}$  is set to 10, i. e. each TDM cycle ( $\tau_c$ ) lasts 100ms. Due to the fact that each TDM interval ( $t_c$ ) is independent from the previous ones, we set  $\tau_s$  to the same value as  $\tau_q$  (1000ms). The number of available lasers is set to 40 (each of them providing a maximum of 10Gbps) which

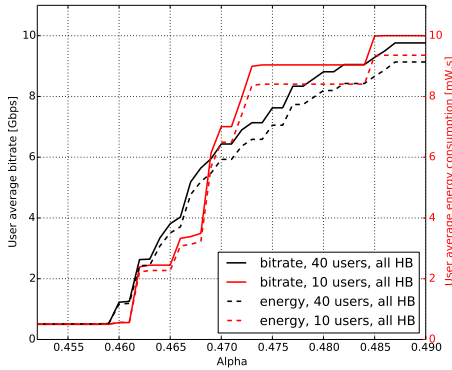

Fig. 7: Exp 1. "All HB" scenarios.

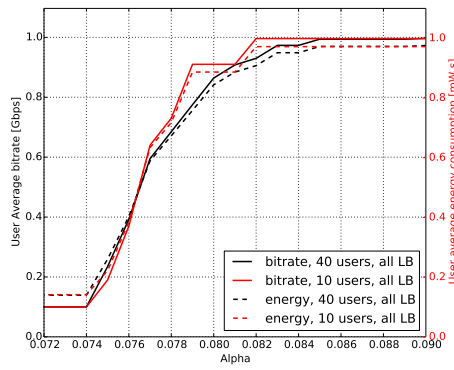

Fig. 8: Exp 1. "All LB" scenarios.

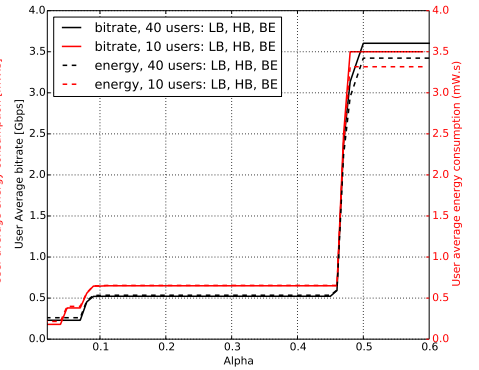

Fig. 9: Exp.1 "HB, LB & BE" scenarios.

means that in all the cases the resources are unlimited. Finally, the minimum bandwidth required per user  $\rho_d$  is set to the device low bandwidth limit ( $r_{d,min}$ ), i.e. 0.5Gbps, 0.1Gbps and 0.005Gbps for HB user, LB user and BE user respectively.

Figures 7, 8 and 9 show the average user bitrate and the user average energy consumption (i.e. how much energy needs to be allocated per user in the system) for different values of the constant  $\alpha$ . First, it can be observed that within each of the cases, independently from the number of the devices to be served, both performance and energy follow a very similar  $\alpha$  trend. However, if we compare the three cases, the critical  $\alpha$  points and the curve-trends are completely different. In the All HB cases (Figure 7) both values are at their constant minimum until  $\alpha$  reaches 0.46. From that moment, energy and average bitrate start increasing until their maximum at  $\alpha$  0.487. They maintain the maximum for the remaining  $\alpha$  values evaluated. The All LB cases, in contrast, have their inflexion points at  $\alpha$  0.074 and  $\alpha$  0.084. Finally, the miscellaneous case (HB, LB & BE) combines the behaviour of both the HB and LE cases, roughly 0.46 and 0.08 respectively, plus an extra critical point at 0.04, which corresponds to the BE users being optimally served.

From these results we can conclude that the optimal value of  $\alpha$  depends only marginally on the number of users and is rather more sensitive to the user's quality requirements. This fact is in itself already an advantage compared to the state-of-the-art on WiFi technologies, 802.11ac. Dianu et al. reported in [34] a decrease of throughput of 30-40% (600Mbps to 400Mbps) due to interference of other channels. Furthermore, due to the energy consumption remaining relatively constant, choosing a value of  $\alpha$  within certain range to fulfill a service quality would suffice. Integrating an automatic selection of the  $\alpha$  of the system could be done by means of machine learning tools based on the users' behavioural patterns.

2) *Exp. 2-Limited resources*: The purpose of this experiment is to quantify the need for TDM techniques in scenarios with limited resources (i.e. limited number of lasers). Furthermore, we aim to determine the impact of the TDM factor  $N_{TDM}$  on the performance.

In order to analyse the influence of the TDM scheme on the overall performance, we chose the All LB and the

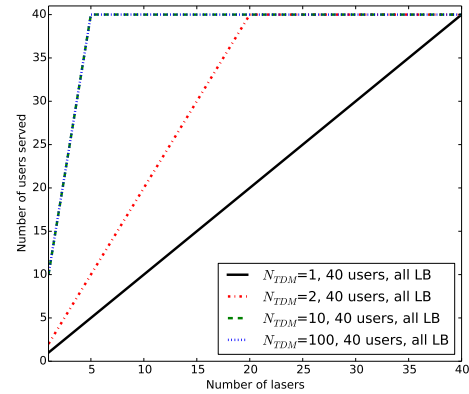

Fig. 10: Exp.2: "All LB", 40 users scenario

miscellaneous cases in their 40 users' variants. The reason for not experimenting with the All HB case, comes from the fact that these users require the full beam to fulfill their requirements, and thus, the number of devices served is equal to the number of lasers available for the room, independently from the TDM granularity ( $N_{TDM}$ ). The value  $\alpha$  was set to 0.8 (Table IV, Exp. 2 column) ensuring maximum quality for all the cases while reducing energy (i.e. switching off PRAs when not in used, etc.). The minimum bandwidth required by the users  $\rho_d$  is set to 0. In this way, we ensure that the optimization algorithm allocates users even if not all them can be serviced (i.e., the resources are not enough to allocate all the users). If the  $\rho_d$  were to be set as in the previous experiment, no optimal solution would be found in certain cases (very low resources, many users). During the tests the TDM factor,  $N_{TDM}$ , takes values ranging from 1 to 100. The number of lasers used ranges from 1 to the number of users in the room (40). Each laser provides a maximum of 10Gbps.

Figures 10, 11 compare the overall performance, in terms of users optimally serviced (qos=1) in relation to the number of lasers used and the TDM factor  $N_{TDM}$ . In both cases, as the number of TDM slots,  $N_{TDM}$ , increases, the number of devices serviced by a small amount of lasers increases. 15 and 5 lasers are required to allocate 40 users for the miscellaneous and the All LB cases respectively.



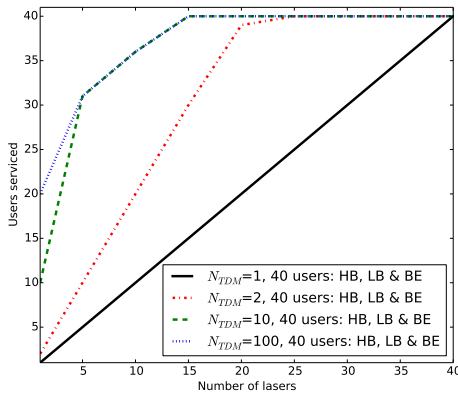

Fig. 11: Exp.2: "HB, LB & BE", 40 users scenario

## VII. CONCLUSION

With the exponential increase of interconnected devices (predicted by the IoT vision), the radio spectrum struggles to fulfill the user's ever growing demands. This situation is even more critical in indoor home environments, in which it is not possible to perform radio management, such as the ones proposed by the Cognitive Radio approaches. In these cases, the standard WiFi, although currently the most widely used, has some physical hurdles that create limitations to the deployment of scenarios such those envisioned by IoT. This motivates the study of alternative solutions that are energy and spectrum efficient, in addition to providing considerably higher bandwidth. OWs offer a very strong alternative to the radio spectrum solution further providing ultra-high bandwidth and interference free transmissions. However, due to the OWs systems stringent requirements, intelligent and novel management techniques have to be developed.

In this paper we have presented a QoS-aware resource allocation model that can provide the tools to fulfill the requirements of a wireless optical system, using the BROWSE framework as case study. We have designed an ILP model that assigns wavelengths to devices and tunes the resulting beams' energy consumption based on device QoS requirements. Given the limited number of simultaneous beams that can be transmitted, due to economical and technical limitations, the model supports TDM to service a large number of users simultaneously in densely populated wireless indoor environments. Only with this simple resource allocation model, the OW system would bring the transmissions of the IoT environments to the next level overpassing the limitations of the congested indoor WiFi systems by providing higher bandwidths and interference-free transmissions.

The satisfactory results provided by our solution, encourage us to continue working towards unlocking the full potential of these new technologies. Our next step is to study how the mobility of users and obstacles affect this type of technology as well as understanding how to integrate it in current WiFi environments and use it complementary, towards hybrid wireless networks.

## ACKNOWLEDGMENT

Funding from the European Research Council in the project BROWSE (Beam-steered Reconfigurable Optical-Wireless System for Energy-efficient communication - Grant 291632) is gratefully acknowledged.

## REFERENCES

- [1] A. Koonen, C. Oh, and E. Tangdiongga, "Reconfigurable Free-Space Optical indoor network using multiple pencil beam steering," in *In Proceedings of OECC / ACOFT 2014*, 2014.
- [2] H. Sundmaeker, P. Guillemin, P. Friess, and S. Woelfflé, Eds., *Vision and Challenges for Realising the Internet of Things*. Luxembourg: Publications Office of the European Union, 2010.
- [3] A. Liotta, "The cognitive NET is coming," *IEEE Spectrum*, vol. 50, no. 8, pp. 26–31, Aug. 2013.
- [4] M. A. Marotta, C. B. Both, J. Rochol, L. Z. Granville, and L. M. R. Tarouco, "Evaluating management architectures for internet of things devices," in *Wireless Days*. IEEE, 2014, pp. 1–7. [Online]. Available: <http://dblp.uni-trier.de/db/conf/wd/wd2014.html#MarottaBRGT14>
- [5] Cisco, "Cisco Virtual Networking Index: Forecast and Methodology, 2010-2015."
- [6] M. Torres Vega, D. C. Mocanu, R. Barresi, G. Fortino, and A. Liotta, "Cognitive streaming on android devices," in *in proc. of the 1st. IEEE/FIP IM 2015 International Workshop on Cognitive Network & Service Management*, May 2015.
- [7] V. Menkovski, G. Exarchakos, and A. Liotta, "Online qoe prediction," in *Quality of Multimedia Experience (QoMEX), 2010 Second International Workshop on*, June 2010, pp. 118–123.
- [8] S. of Motion Picture and I. S. Television Engineers, "SMTPE 2036: Ultra High Definition Television."
- [9] G. Dede, T. Kamalakis, and D. Varoutas, "Evaluation of Optical Wireless Technologies in Home Networking: Analytical Hierarchy Process Approach," *Journal of Optical Communications and Networking*, vol. 3, no. 11, Nov. 2011.
- [10] C. Oh, E. Tangdiongga, and A. Koonen, "Steerable pencil beams for multi-gbps indoor optical wireless communication," *OPTICS LETTERS*, vol. 39, no. 18, Sep. 2014.
- [11] A. Liotta and G. Exarchakos, *Network for Pervasive Applications*. Springer, 2011.
- [12] B. Ishibashi, N. Bouabdallah, and R. Boutaba, "Qos performance analysis of cognitive radio-based virtual wireless networks," in *INFOCOM*. IEEE, 2008, pp. 2423–2431. [Online]. Available: <http://dblp.uni-trier.de/db/conf/infocom/infocom2008.html#IshibashiBB08>
- [13] M. A. Marotta, N. Kaminski, L. Z. Granville, J. Rochol, L. A. DaSilva, and C. B. Both, "Resource sharing in heterogeneous cloud radio access networks," *IEEE Wireless Commun.*, vol. 22, no. 3, pp. 74–82, 2015. [Online]. Available: <http://dblp.uni-trier.de/db/journals/wc/wc22.html#MarottaKGRDB15>
- [14] M. Uysal and H. Nouri, "Optical wireless communications-an emerging technology," in *16th International Conference on Transparent Optical Networks (ICTON)*, Jul. 2014.
- [15] A. M. J. Koonen and E. Tangdiongga, "Photonic Home Area Networks," *Journal for Lightwave Technologies*, vol. 32, no. 4, Feb.
- [16] C. W. Oh, E. Tangdiongga, and A. M. J. Koonen, "42.8 gbit/s indoor optical wireless communication with 2-dimensional optical beam-steering," 2015.
- [17] M. Kotaru, K. R. Joshi, D. Bharadia, and S. Katti, "Spotfi: Decimeter level localization using wifi," in *Proceedings of the 2015 ACM Conference on Special Interest Group on Data Communication, SIGCOMM 2015, London, United Kingdom, August 17-21, 2015*, 2015, pp. 269–282. [Online]. Available: <http://doi.acm.org/10.1145/2785956.2787487>
- [18] P. Jiang, Y. Zhang, W. Fu, H. Liu, and X. Su, "Indoor mobile localization based on wi-fi fingerprints important access point," *Int. Journal of Distributed Sensor Networks*, vol. 2015, 2015.
- [19] P. Thysebaert, M. D. Leenheer, B. Volckaert, F. D. Turck, B. Dhoedt, and P. Demeester, "Scalable dimensioning of optical transport networks for grid excess load handling," *Photonic Network Communications*, vol. 12, no. 2, pp. 117–132, 2006. [Online]. Available: <http://dblp.uni-trier.de/db/journals/pnc/pnc12.html#ThysebaertLVTDD06>

- [20] R. Vilalta, R. Muñoz, R. Casellas, and R. Martínez, "Virtual optical network resource allocation using pce global concurrent optimization for dynamic deployment of virtual gmpls-controlled wson," *Journal of Optical Communications and Networking*, vol. 5, no. 12, 2013.
- [21] G. Marsh and J. M. Kahn, "Channel reuse strategies for indoor infrared wireless communications," in *Global Telecommunications Conference, 1996. GLOBECOM '96. 'Communications: The Key to Global Prosperity'*, 1996.
- [22] S. Dimitrov, R. Mesleh, H. Haas, M. Cappitelli, M. Olbert, and E. Bassow, "On the sir of a cellular infrared optical wireless system for an aircraft," *IEEE Journal on Selected Areas in Communications*, vol. 27, no. 9, pp. 1623–1638, 2009. [Online]. Available: <http://dblp.uni-trier.de/db/journals/jsac/jsac27.html#DimitrovMHCOB09>
- [23] B. Ghimire and H. Haas, "Resource Allocation in Optical Wireless Networks," in *22nd IEEE International Symposium on Personal Indoor and Mobile Radio Communications (PIMRC)*.
- [24] Y. Chen, T. Farley, and Y. Nong, "Qos requirements of network applications on the internet," *Systems Management*, vol. 4, 2004.
- [25] N. Gvozdiev, B. Karp, and M. Handley, "Fubar: Flow utility based routing," in *13th ACM Workshop on Hot Topics in Networks, SIGCOMM*, 2014.
- [26] A. M. J. Koonen, C. Oh, K. Mekonnen, and E. Tangdiongga, "Ultra-high capacity indoor optical wireless communication using steered pencil beams," in *In proc. of the Int. Topical Meeting on Microwave Photonics (MWP)*, Oct. 2015.
- [27] "Discovery Semiconductors, Inc." <http://www.discoverysemi.com/Product>
- [28] "u2t," <https://www.finisar.com/optical-components>.
- [29] "Gooch & housego," <http://goochandhousego.com/>.
- [30] S. of Motion Picture and Television Engineers (SMTPE), "Initial Report of the UHDTV Ecosystem Study Group," 2013.
- [31] R. R. White, P., "Performance and Reliability: Home Network Technology Standard Comparison," 2015.
- [32] ExtremeTech, "What is 802.11ac wifi, and how much faster than 802.11n is it?" <http://www.extremetech.com/computing/160837-what-is-802-11ac-and-how-much-faster-than-802-11n-is-it>.
- [33] O. Femijemilohun and S. Walker, "Empirical performance evaluation of enhanced throughput schemes of IEEE802.11 technology in wireless area networks," *CoRR*, vol. abs/1309.2789, 2013. [Online]. Available: <http://arxiv.org/abs/1309.2789>
- [34] M. D. Dianu, J. Riihijarvi, and M. Petrova, "Measurement-based study of the performance of ieee 802.11ac in an indoor environment," in *2014 IEEE International Conference on Communications (ICC)*, Jun. 2014.