

## Assessment criteria for assessing energy-absorbing front underrun protection on trucks

**Citation for published version (APA):**

Schram, R., Leneman, F. J. W., Zweep, van der, C. D., Wismans, J. S. H. M., & Witteman, W. J. (2006). Assessment criteria for assessing energy-absorbing front underrun protection on trucks. In *International Crashworthiness Conference Proceedings ICrash 2006, Athens Greece, 4th-7th July 2006* (pp. 597-604). (International Journal of Crashworthiness; Vol. 11). <https://doi.org/10.1533/ijcr.2006.0154>

**DOI:**

[10.1533/ijcr.2006.0154](https://doi.org/10.1533/ijcr.2006.0154)

**Document status and date:**

Published: 01/01/2006

**Document Version:**

Accepted manuscript including changes made at the peer-review stage

**Please check the document version of this publication:**

- A submitted manuscript is the version of the article upon submission and before peer-review. There can be important differences between the submitted version and the official published version of record. People interested in the research are advised to contact the author for the final version of the publication, or visit the DOI to the publisher's website.
- The final author version and the galley proof are versions of the publication after peer review.
- The final published version features the final layout of the paper including the volume, issue and page numbers.

[Link to publication](#)

**General rights**

Copyright and moral rights for the publications made accessible in the public portal are retained by the authors and/or other copyright owners and it is a condition of accessing publications that users recognise and abide by the legal requirements associated with these rights.

- Users may download and print one copy of any publication from the public portal for the purpose of private study or research.
- You may not further distribute the material or use it for any profit-making activity or commercial gain
- You may freely distribute the URL identifying the publication in the public portal.

If the publication is distributed under the terms of Article 25fa of the Dutch Copyright Act, indicated by the "Taverne" license above, please follow below link for the End User Agreement:

[www.tue.nl/taverne](http://www.tue.nl/taverne)

**Take down policy**

If you believe that this document breaches copyright please contact us at:

[openaccess@tue.nl](mailto:openaccess@tue.nl)

providing details and we will investigate your claim.

## **Assessment criteria for assessing energy absorbing Front Underrun Protection on Trucks**

R Schram\*, F J W Leneman\*, C D van der Zweep\*, J S H M Wismans\*/\*\*  
and W J Witteman\*\*

\* *TNO Science and Industry, Business Unit Automotive, Safety Department, Schoemakerstraat 97, Delft, The Netherlands*

\*\**Eindhoven University of Technology, Faculty of Mechanical Engineering, Section Materials Technology Den Dolech 2, Eindhoven, The Netherlands*

**Abstract** - The objective of this paper is to investigate the possibilities to assess (energy absorbing) Front Underrun Protection (FUP) devices with respect to injuries of the car occupant without using a car and dummy in the test procedure. A large number of different crash configurations are simulated to search for a clear relationship between injury and vehicle criteria. Secondly, a representative structure that can replace a car was found.

The simulation results show a correlation between injury levels given by the HARM and the accident severity, given by the ASI value. Furthermore, the simulation results show that energy absorption in the FUP lowers the ASI level for all crash scenarios which consequently results in lower injury levels.

The main conclusion is that it is possible to assess the eaFUP performance based on vehicle acceleration signals (non-dummy signals). A component test procedure for assessing eaFUP can be developed based on these simulation results.

For a future test procedure a combination of experimental and virtual testing is proposed. With virtual testing the behaviour of the eaFUP in different crash scenarios can be evaluated.

### **NOTATION**

<i>FUP</i>	<i>Frontal Underrun Protection</i>
<i>eaFUP</i>	<i>energy absorbing FUP</i>
<i>AIS</i>	<i>Abbreviated Injury Scale</i>
<i>ASI</i>	<i>Acceleration Severity Index</i>
<i>THIV</i>	<i>Theoretical Head Impact Velocity</i>
<i>MDB</i>	<i>Moving Deformable Barrier</i>
<i>MPDB</i>	<i>Moving Progressive Deformable Barrier</i>

### **INTRODUCTION**

In the European Union, around 40,000 traffic fatalities occur and over 1.6 million people are injured annually [1]. The aim of the European Commission is to reduce the fatality figures by 50% by the year 2010 with the year 2000 as a reference. Different research projects are initialized to help realize this goal. One of these projects is Vehicle Crash Compatibility (VC-Compat). This project is focused on the development of test procedures to improve vehicle crash compatibility [2]. The VC-Compat project contains two legs; car-to-car and car-to-truck. This paper describes work performed for the car-to-truck leg of the project.

Compatibility is an issue of self- and partner protection. There are four major factors within compatibility: mass, structural interaction, stiffness and compartment strength [2]. In car-to-truck collisions compatibility is mainly partner protection from the trucks point of view due to the large difference in weight and size of both vehicles. Compartment strength of the passenger car is needed to provide sufficient survival space for the car occupant. This is mainly an issue of self protection of the car and in this paper it is assumed to be present. The difference in mass is a given factor. Structural interaction and stiffness are the two main compatibility factors in car-to-truck compatibility which can be influenced.

Of all the traffic fatalities, car-to-truck crashes account for 15%, of which half is front-to-front [3]. The main reason for fatalities in front-to front car-to-truck crashes is underrun due to poor structural interaction. Since August 2003, in the European Union new trucks must be installed with an adequate FUP corresponding to ECE R93 [3]. The regulation states that the FUP is allowed to deflect 400mm backwards after applying a static load representing 50% of the maximum weight of the truck with a maximum load of 160kN.

All FUPs deform during a crash and therefore absorb energy. Research performed by EEEVC Working Group 14 shows that a substantial amount of energy absorption in the FUP is beneficial with respect to injuries [4,5]. In the VC-Compat project full scale car-to-truck tests were performed to show the effect of energy absorption in the FUP on the injury level of the car occupant. They showed that energy absorption in the FUP is beneficial with respect to injury values.

The goal of the car-to-truck leg of the VC-Compat project is to develop a simplified test procedure for assessing eaFUPs, where the car is replaced by a 'representative structure'. Nowadays the effectiveness of an energy absorbing underride system can only be assessed by investigating injury criteria from the passenger car colliding with the truck.

The goal of this research is to investigate criteria for the assessment of energy absorbing FUP on trucks without using a car and dummy in the testprocedure [1].

## **METHODOLOGY**

This research starts with a short review of the used vehicle criteria and injury severity quantities. When it would be possible to establish a clear relationship between dummy and vehicle criteria the injury severity could be predicted directly from the vehicle data, which would exclude the dummy in the test procedure. This possible relationship will be based on a large number of different simulated crash configurations. Accident analysis showed that the initial velocity and overlap are the main crash parameters [3]. They will be varied in a range based on accident analysis performed in the VC-Compat project. In addition the benefit of an energy absorbing FUP compared to a rigid one is investigated based on the relationship found.

The next step is to find a 'representative structure' that can replace the car in the test procedure. This structure needs to be representative for the European passenger car fleet. In a numerical study by van Ast, different Moving Deformable Barriers were investigated as impactor in a new testprocedure for assessing compatibility of cars [12]. The USNCAP Side Impact trolley equipped with a Progressive Deformable Barrier (PDB) was chosen as the best Moving Deformable Barrier and called the Moving Progressive Deformable Barrier (MPDB) because this barrier replicates a standard European car the best. The numerical model of the MPDB is compared with the vehicle models used in this study.

Finally, the influence of rigid parts in the front-end of the truck on energy absorption in the FUP is investigated to make clear which parts need to be taken into account in a future procedure where the truck is replaced by components.

## **CRITERIA**

The most well-known injury severity quantity is the AIS. The AIS distinguishes six levels of injury as shown in Table 1. The AIS is a "threat to life" ranking. The numerical values have no significance other than to designate order. Therefore the AIS are not based on any measurable parameter [6].

Table 1 The Abbreviated Injury Score (AIS) [6]

AIS	Severity code
0	No injury
1	Minor
2	Moderate
3	Serious
4	Severe
5	Critical
6	Maximum (virtually unsurvivable)
9	Unknown

NHTSA developed Injury Risk Functions to give the relationship between injury criteria and the probability of having a certain AIS-level or higher. For six injury criteria these injury risk curves are available; HIC, Nij, CTI, C3ms, Chest Deflection and FFC. The injury risk curves will be used to transform these six injury criteria into one AIS value. Because the AIS numbering has no significance other than designate order, other weight factors are used to combine the probabilities of having certain AIS levels into one single AIS value. The medical cost is taken as weight factors for the different MAIS levels because they are the only recent values found in literature and are shown in Table 2.

Table 2 The medical costs for each MAIS level [10]

MAIS	Medical cost [\$]
0	1
1	2.380
2	15.625
3	46.495
4	131.306
5	332.457
6	22.095

The HARM concept is an attempt to assign an average economic cost to an AIS value [3]. The US government uses the HARM score for instance to calculate the effect of various governmental interventions.

For each injury criterium where the injury risk function is known, the expected medical cost is calculated by summing the probabilities of the injury risk curves using the medical cost for every AIS level as weight factors as shown below [7]:

$$E(X) = \sum_i w_i P(X, w_i), \text{ where } i \in [0..6] \quad [1]$$

Where:

$E(X)$ : Expected medical cost for injury criterion value X

$X$ : Injury criterion value

$w_i$ : Medical cost for every AIS level

$P(X, w_i)$ : Probability of injury criterion value X at given AIS level

$$\begin{pmatrix} w_0 \cdot P(0) \\ w_1 \cdot P(1) \\ w_2 \cdot P(2) \\ w_3 \cdot P(3) \\ w_4 \cdot P(4) \\ w_5 \cdot P(5) \\ \frac{w_6 \cdot P(6) +}{E} \end{pmatrix} = \begin{pmatrix} w_0 \cdot (P(0+) - P(1+)) \\ w_1 \cdot (P(1+) - P(2+)) \\ w_2 \cdot (P(2+) - P(3+)) \\ w_3 \cdot (P(3+) - P(4+)) \\ w_4 \cdot (P(4+) - P(5+)) \\ w_5 \cdot (P(5+) - P(6)) \\ \frac{w_6 \cdot P(6) +}{E} \end{pmatrix} \quad [2]$$

$$\Rightarrow E(X) = \sum (w_i - w_{i-1})P(X, w_i)$$

The economic values shown in Table 2 are medical costs for the Maximum AIS level of a car crash victim. Therefore the HARM is set equal to the maximum value medical cost calculated for the six injury criterion used because this automatically corresponds to the MAIS level. It is chosen not to transform the HARM back to an expected MAIS level, but to use the HARM as a measure to see the benefit of an energy absorbing FUP compared to a rigid one.

## VEHICLE CRITERIA

Vehicle criteria are not as well known as injury criteria. Measurable parameters are vehicle deformation, vehicle acceleration and intrusion. The Acceleration Severity Index (ASI), Equation 3, is used to assess road side barriers [8], and is intended to give a measure of the severity of the vehicle motion for an occupant seated at the drivers' seat during an impact.

$$ASI(t) = \left[ (\bar{a}_x / \hat{a}_x)^2 + (\bar{a}_y / \hat{a}_y)^2 + (\bar{a}_z / \hat{a}_z)^2 \right]^{1/2} \quad [3]$$

Where:

- $\hat{a}_i$ : limit values for the acceleration along the body axes, with  $i = x, y, z$
- $\bar{a}_i$ : acceleration components measured at drivers seat, averaged over a moving 50ms interval, with  $i = x, y, z$

The maximum ASI value in a collision is assumed to be a single measure of the severity, thus:

$$ASI = MAX[ASI(t)] \quad [4]$$

Another vehicle criterion that is based on the acceleration of the vehicle is the Theoretical Head Impact Velocity (THIV) [11]. The occupant is considered to be a free moving object (head) that, as the vehicle changes its velocity during contact with the restraint systems, continues moving until it strikes a virtual surface within the interior of the vehicle. The impact velocity of the head is a measure for impact severity. The disadvantage of THIV is that it assumes that the occupant is not wearing a seatbelt or the use of an airbag. The THIV is expressed in km/h. The calculation of the THIV is documented in EN1317-1 [11].

Because the THIV assumes that the occupant is not restraint during the impact and because the ASI and THIV are based on the same acceleration signals only the ASI is used in this study.

## SIMULATION SET-UP

The multi-body module of the crash simulation program MADYMO [9] is used to find a relationship between the vehicle and injury criteria. The low CPU-time of a multi-body simulation compared to a finite element simulation gives the possibility to simulate a large number of different crash-scenarios.

Table 3 Vehicle model details [7]

Vehicle Model	Class	Mass [kg]	Test mass [kg]
Ford Crown Victoria (CV)	Large	1836	2076
Ford Explorer (EX)	SUV	1971	2205
Chrysler Neon (NE)	Compact	1085	1371
Chrysler Neon with added subframe (N1)	Compact	1111	1397

The truck model shown in Figure 1 is developed by TNO for the VC-Compat project and is based on a current truck model. All the major structural parts in the front-end of the truck are modelled. In this study the FUP is the most important element. The FUP device is modeled by nine connected bodies and is visualized by nine ellipsoids. The FUP is connected to the chassis beams by a translational joint. The translational joint has only one degree of freedom which allows the FUP to move backwards during impact. Two different types of FUP's are used in this study: one so called rigid FUP and an energy absorbing eaFUP. For the rigid FUP the characteristic of the translational joint is almost rigid, leaving a maximum deformation of 100mm based on R93 test results gathered in the VC-Compat project. The joint-characteristic for the eaFUP allows the FUP to move backwards for 400mm at a force level of 250kN. This force level provides enough resistance during impact to ensure stable deformation of the car and that the restraint systems of the car will work properly.

The front-end of the truck also contains a steering unit, towing hooks, cooling unit and bumper beam as shown in Figure 1. Note that the bumper beam is not the same as the FUP, but should be seen as the crossmember between the chassis beams.

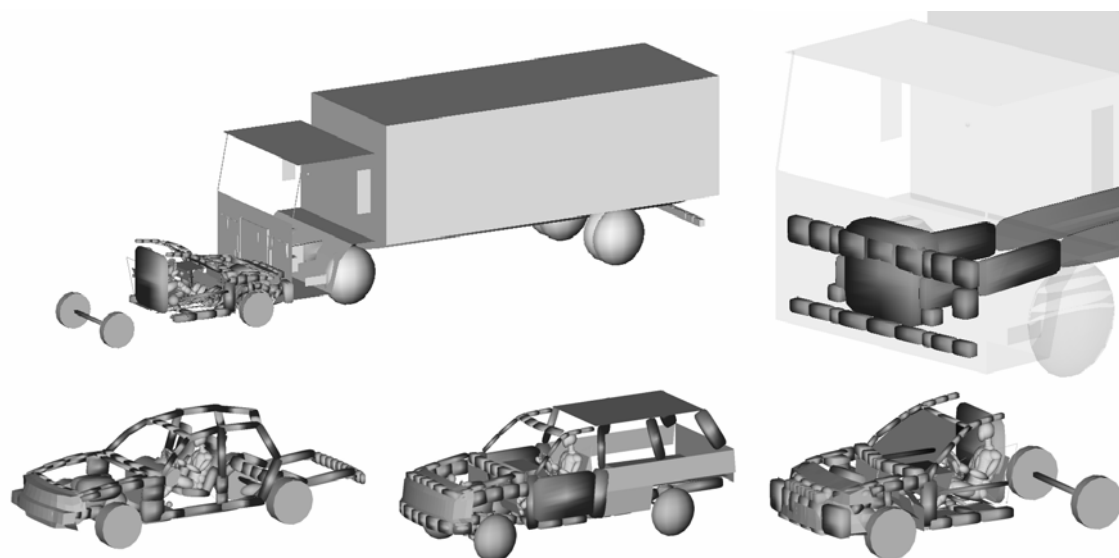

Figure 1. MADYMO models used in this study. Top left, the truck model and the Chrysler Neon (NE). Top right, main structures of the trucks front end colored dark. Left bottom, the Ford Crown Victoria (CV). Middle bottom, Ford Explorer (EX). Right bottom, Chrysler Neon with subframe (N1).

The MADYMO car-models that are used in this study are representative for the US fleet [7]. Four car models are used in this study, a compact car with and without subframe, a large passenger car and a SUV, see Figure 1. In all the simulations a Hybrid III 50th percentile dummy is used for the drivers position.

Within the VC-Compat project an accident analysis study is performed and based on this analysis crash scenarios are generated using the stochastic tool ADVISER. The analysis showed that the impact angle is zero degrees for over 75% of the cases. Therefore this crash-scenario parameter is not varied in this study, and is set to zero degrees. The initial velocity is varied between 56 and 100 km/h and the overlap is varied between 35 and 100%. The initial velocity is given to the car only. The truck has zero velocity to have a correspondance with the real-life crash tests performed within the project. This does not affect the severity of the crash.

With the use of ADVISER 150 random combinations of initial velocity and overlap are generated. Consequently, 1200 simulations are performed in total using the four different vehicles and two different type of FUP.

## **RELATIONSHIP BETWEEN INJURY AND VEHICLE CRITERIA**

The search for a relationship between injury and vehicle criteria is done based on the simulation results and the real-life tests performed in the VC-Compat project. The dummy results used in both simulation and real-life tests are combined in one single value HARM as explained earlier. The B-pillar acceleration of the vehicles is used to calculate the ASI value.

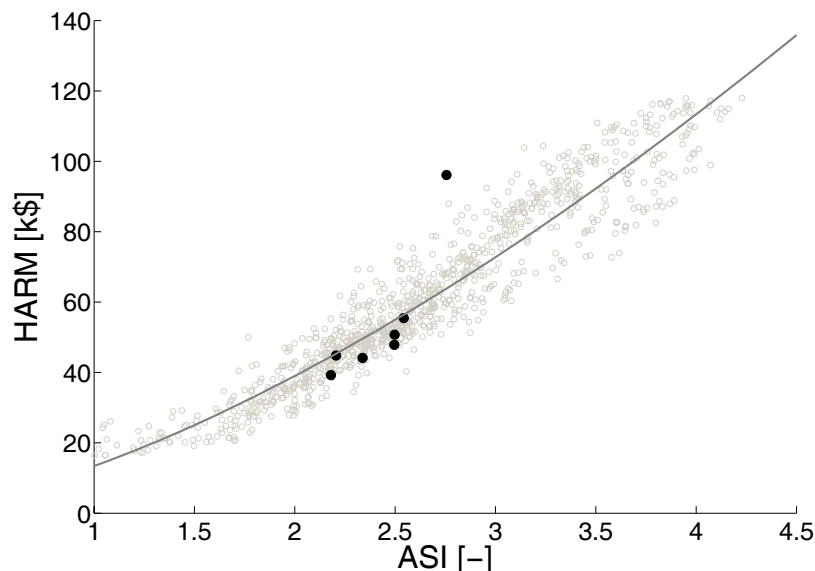

Figure 2. ASI versus HARM for simulations (gray) and real-life tests (black).

Figure 2 shows the ASI and corresponding HARM for each simulation performed as a circle. The simulations show a relationship between the ASI and the HARM. With the use of the statistical program SPSS a regression curve is fitted onto the simulation results. The regression curve, with the following equation is also shown in the figure.

$$HARM = 13,401 \times ASI^{1.54} \quad [5]$$

The R-squared value of this power-curve is 0.91 and the correlation is significant, as calculated by SPSS.

Finally the real-life test results are used to validate the simulation results. Table 4 gives an overview of the tests performed within the VC-Compat project.

Table 4 Real-life test specifications and results

Car	Speed [km/h]	Overlap [%]	FUP	ASI	HARM
Small family	64	75%	Rigid	2.5	47836
Small family	75	75%	Rigid	2.8	96099
Small family	56	75%	Rigid	2.2	44821
Small family	64	75%	Rigid	2.5	50740
Compact	64	75%	Rigid	2.2	39260
Compact	75	75%	Energy Absorbing	2.3	44124
Compact	75	75%	Rigid	2.5	55450

The ASI-HARM values of the real-life tests are shown in Figure 2 as filled dots. They are shown to be inline with the simulation results. One test does not comply with the simulation and other tests. This is due to a high HIC value, because the airbag deployed too late in the test. For all other tests the restraint systems worked well, as is the case in the simulations.

### BENEFIT OF EAFUP COMPARED TO RIGID

From the simulations and real-life tests the effect of energy absorption in the FUP on the severity of the crash can be determined. This is done by directly comparing the mean HARM of the simulations for different ranges of impact velocities and overlap. Only the simulations that terminated normally for both cases were used in the comparison. The effect of energy absorption on accident severity expressed in HARM for the initial velocity and overlap are seen in respectively Figure 3 and Figure 4.

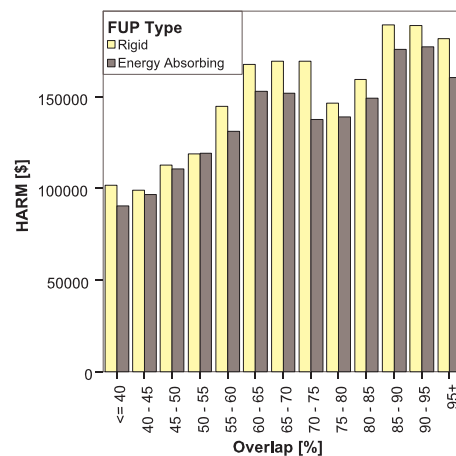
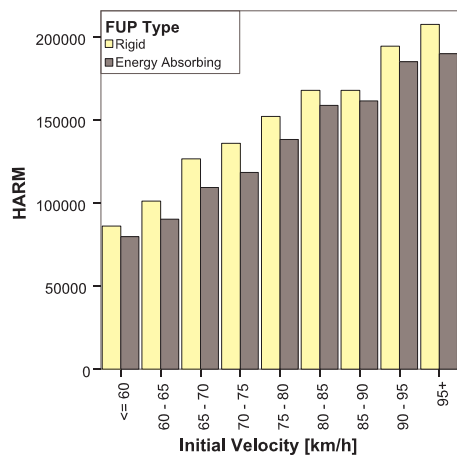

Figure 3- Mean HARM for different ranges of initial velocity, for rigid and energy absorbing FUPs. Figure 4- Mean HARM for different ranges of overlap, for rigid and energy absorbing FUPs.

The figures clearly show that the Energy Absorbing FUP is beneficial for all the overlap and velocity ranges compared to the rigid FUP. The same effect accounts for the ASI comparison because of the relationship established earlier. This effect on the ASI and therefore HARM is best seen when the acceleration curves for both the rigid and the eaFUP are compared. Figure 5 shows the acceleration curves for the Chrysler Neon with subframe. It is seen that the peak acceleration is lowered and on a later moment in time resulting in a lower ASI value.



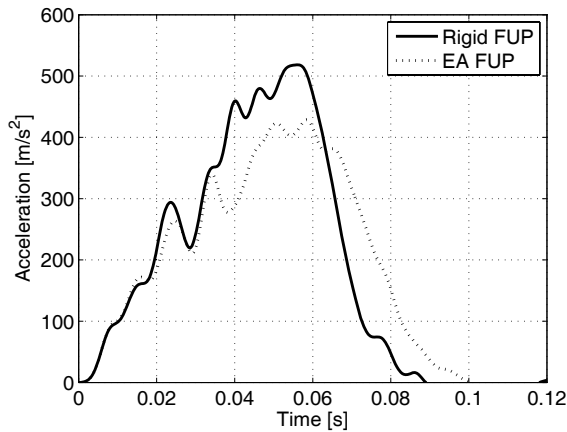

Figure 5 – Simulation acceleration curves for the Compatible Chrysler Neon at 75 km/h and 75% overlap

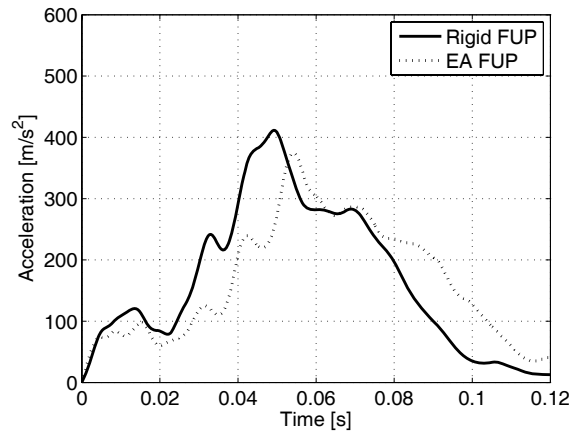

Figure 6 –Real-life crash-test acceleration curves for a compact car at 75 km/h and 72% overlap

For the real life tests this same effect is seen in the acceleration signal of the compact car at 75 km/h and 75% overlap, shown in Figure 6. The force level on which the energy absorbing material deforms in the real-life crash test is lower than in the simulations and therefore the effect is less compared to the simulations but it is still clearly seen.

## MPDB SIMULATIONS

With the use of numerical simulations the MPDB is assessed for the usability as a representative structure for a car in car-to-truck crash-tests. The MPDB is equipped with a PDB barrier, which is designed for compatibility assessment by assessing the deformation of the barrier. The stiffness of the PDB is based on the average European car [12]. Van Ast developed a numerical version of a Moving PDB (MPDB) to be able to take mass difference of two colliding vehicles into account as well [12].

As mentioned earlier the PDB barrier assessment is performed based only on the deformation of the barrier. Therefore the barrier is not allowed to bottom out during tests. Because there is only a small contact area in which the MPDB has to absorb the energy the risk of bottoming out is increased. The bottoming out of the barrier will also lead to very high acceleration levels. The effect of the crash configuration on bottoming out of the MPDB is investigated by checking the maximum acceleration level. This maximum acceleration level is compared with the maximum acceleration level of the used vehicles as well to see how well they correspond.

The peak acceleration for both the vehicles and the MPDB simulations versus the initial velocity are shown in Figure 7. It is shown that the MPDB already starts to bottom out at a velocity of 60 km/h, depending on the overlap.

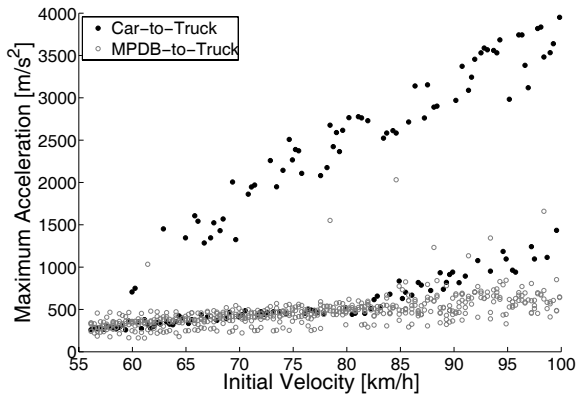

Figure 7. Maximum acceleration values for both the MPDB-to-truck and car-to-truck simulations versus the initial velocity

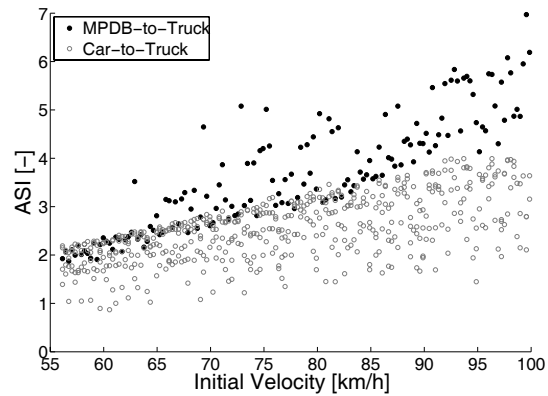

Figure 8 – ASI values for both car-to-truck and MPDB-to-truck simulations versus the initial velocity

In accordance the ASI values of the MPDB are increasing when the barrier bottoms out, and therefore are no longer usable to predict the HARM. The ASI values versus the initial velocity, see Figure 8, show that the ASI of the MPDB is corresponding with the ASI values found in the car-to-truck simulations up to 65 km/h. This implicates that the MPDB represents the average European car only at velocities below 65 km/h.

## TRUCK FRONT END

In car-to-truck collisions the car not only interacts with the FUP during impact, but it will hit other rigid parts as well. The front of a truck contains towing hooks, a steering unit and a cooling unit which are also represented in the numerical truck model introduced before. These parts will make contact with the car in a frontal car-to-truck collision. Consequently, these rigid parts in the front of the truck reduce the force transferred to the FUP resulting in less deformation of the FUP and therefore less energy absorption in the FUP. By removing contact definitions between the vehicle model and these rigid parts in the front of the truck the effect these rigid parts have on the displacement of the FUP, and therefore energy absorption in the FUP, can be shown by comparing the displacement. The removing of the contact definitions is done in steps. First the contact with the towing hooks is removed. Second the contact with the steering unit, and at last also the contact with the cooling unit is deleted. This last step however is not very realistic.

Figure 9 shows the mean displacement of the FUP for nine different crash scenarios using the four vehicle models.

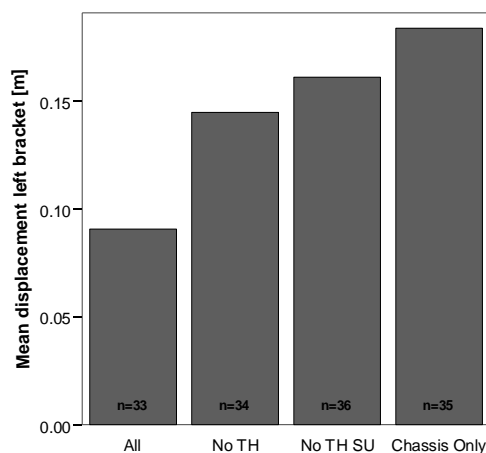

Figure 9- Mean bracket displacement for different configurations.(TH: Towing Hooks, SU: Steering Unit, Chassis Only: No TH SU and Cooling Unit)

The left bar in

Figure 9 shows the displacement for the original truck with all contacts present. The next bars show that the displacement increases when these rigid parts are removed. The largest displacement is seen when all the rigid parts in the front-end of the truck are removed and only the chassis beams interfere with the force transferred to the FUP.

For a future test procedure where the truck is replaced by some kind of component test, Figure 9 implies that the other rigid parts in the front-end of the truck need to be taken into account as well.

## CONCLUSIONS AND RECOMMENDATIONS

Simulations have shown a relationship between the ASI and the HARM in car-to-truck collisions. The performed crash-tests are in-line with this correlation, but only when the restraint systems worked properly. This relationship gives the possibility to develop a test procedure using an impactor only without using a dummy.

Simulations also show, for the entire range of simulated crash-scenarios, that an eaFUP is beneficial compared to a rigid one based on the HARM. This positive effect on HARM is due to the lowered and post-poned vehicle acceleration peak. This effect is seen in both simulations as well as in real-life tests.

The MPDB is a representative structure for representing the average European car, but only at low velocities to avoid bottoming out of the PDB barrierfront. However, frontal car-to-truck accidents tend to happen at much higher velocities. For these higher velocities the MPDB can not be used with current stiffness levels of the PDB.

In a future test procedure where a full car-to-truck test is replaced by some kind of component test with the FUP, the other rigid components in the front-end of the truck should be taken into account as well. It was shown that they interfere with the force transfer between the FUP and the impacting vehicle.

The used vehicle models in this study are representative for the US vehicle fleet. This fleet is outdated and the current European vehicle fleet tends to be a lot stiffer. Therefore, a numerical European vehicle fleet is needed to check the found correlation between the ASI and HARM. This correlation also needs to be validated for other crash scenarios, for instance car-to-car or car-to-barrier scenarios.

More research is needed on overall body injury criteria and on the relationship between AIS and injury criteria to have a better comparison between measured injury criteria and real-life AIS values. The PDB barrier used for the MPDB has the potential of bottoming out at high velocities due to the small contact area in MPDB-to-truck impacts. Therefore a new barrier needs to be developed which can cope with the small contact area and represent an average European car in truck impacts.

## **ACKNOWLEDGEMENTS**

This study was financed by TNO Automotive, Dutch Ministry of Transport, Public Works and Water Management and the European Commission in the 5th Framework project VC-Compat. Furthermore we acknowledge the Automotive Engineering Science section of the Eindhoven, University of Technology for the use of their crash sled.

## **REFERENCES**

- [1] VC-Compat project website: <http://vc-compat.rtdproject.net/>.
- [2] M. Edwards, A study to improve the crash compatibility between cars in frontal impact, PR/SE/521/02, Transport Research Laboratory, 2002
- [3] Johann Gwehenberger, Jenö Bende, Ian Knight, Cees Klootwijk, 'Collection of existing in-depth accident cases and prediction on having front and rear underrun protection', VC-Compat Task 2.7/2.8
- [4] Malliaris, A.C. et. al., 'Harm Causation and ranking in car crashes', SAE Paper 85090, Society of Automotive Engineers, Inc.
- [5] ECE R93, Front Underrun Protection, website:  
[http://www.unece.org/trans/main/wp29/wp29regs/r093e\\_1;](http://www.unece.org/trans/main/wp29/wp29regs/r093e_1;)  
[http://www.unece.org/trans/main/wp29/wp29regs/r093e\\_2](http://www.unece.org/trans/main/wp29/wp29regs/r093e_2)
- [6] EEVC Working Group 14 Report, Development of Test Procedure for Energy-absorbing Front Underrun Protection Systems for Trucks, December 1996
- [7] C. Avedal, L Forsman, Volvo Truck Corporation, Accident Research Team/Cab Analysis, Safety & Environment Seminar, June 2002.
- [8] J.S.H.M. Wismans, E.G. Janssen, M. Beusenberg, W.P. Koppens, R. Happee, P.H.M. Bovendeerd, Injury Biomechanics, Lecture notes college 4J610, Eindhoven University of Technology, Eindhoven, The Netherlands, 2000.
- [9] TNO MADYMO BV, MADYMO V6.2, Theory Manual, TNO, June 2004
- [10] C.D. van der Zweep, G. Kellendonk, F.J.W. Leneman, P.P.M. Lemmen, F. Bronckers, Numerical fleet studies 2002-2003, Final report, 03.OR.BV.067.1/CVDZ, TNO Automotive, Delft, The Netherlands, 2003
- [11] CEN, Road restraint systems – Part1:Terminology and general criteria for test methods, EN 1317-1, March 1998
- [12] Van Ast, A moving deformable barrier crash test procedure for assessing compatibility in frontal collisions,04.OR.SA.0671/CvdZ, TNO Automotive, Delft, The Netherlands.
- [13] Blincoe, J et al, The economic impact of motor vehicle crashes 2000, NHTSA, May 2000