

Aggregation methods for Markov reward chains with fast and silent transitions

Citation for published version (APA):

Markovski, J., & Trcka, N. (2007). *Aggregation methods for Markov reward chains with fast and silent transitions*. (Computer science reports; Vol. 0708). Technische Universiteit Eindhoven.

Document status and date:

Published: 01/01/2007

Document Version:

Publisher's PDF, also known as Version of Record (includes final page, issue and volume numbers)

Please check the document version of this publication:

- A submitted manuscript is the version of the article upon submission and before peer-review. There can be important differences between the submitted version and the official published version of record. People interested in the research are advised to contact the author for the final version of the publication, or visit the DOI to the publisher's website.
- The final author version and the galley proof are versions of the publication after peer review.
- The final published version features the final layout of the paper including the volume, issue and page numbers.

[Link to publication](#)

General rights

Copyright and moral rights for the publications made accessible in the public portal are retained by the authors and/or other copyright owners and it is a condition of accessing publications that users recognise and abide by the legal requirements associated with these rights.

- Users may download and print one copy of any publication from the public portal for the purpose of private study or research.
- You may not further distribute the material or use it for any profit-making activity or commercial gain
- You may freely distribute the URL identifying the publication in the public portal.

If the publication is distributed under the terms of Article 25fa of the Dutch Copyright Act, indicated by the "Taverne" license above, please follow below link for the End User Agreement:

www.tue.nl/taverne

Take down policy

If you believe that this document breaches copyright please contact us at:

openaccess@tue.nl

providing details and we will investigate your claim.

Aggregation Methods for Markov Reward Chains with Fast and Silent Transitions

J. Markovski* and N. Trčka**

Technische Universiteit Eindhoven, Formal Methods Group
Den Dolech 2, 5612 AZ, Eindhoven, The Netherlands
j.markovski@tue.nl, n.trcka@tue.nl

Abstract. We analyze derivation of Markov reward chains from intermediate performance models that arise from formalisms for compositional performance analysis like stochastic process algebras, (generalized) stochastic Petri nets, etc. The intermediate models are typically extensions of continuous-time Markov reward chains with instantaneous labeled transitions. We give stochastic meaning to the intermediate models using stochastically discontinuous Markov reward chains, for which there are two prominent methods for aggregation: lumping and reduction to a pure Markov reward chain. As stochastically discontinuous Markov reward chains are not intuitive in nature, we consider Markov reward chains extended with transitions that are parameterized by a real variable. These transitions are called fast transitions, when they are governed by explicit probabilities, and silent transitions, when the probabilities are left unspecified. In the asymptotic case when the parameter tends to infinity, the models have a behavior of a stochastic discontinuous Markov reward chains. For all Markovian models, we develop two aggregation methods, one based on reduction and another one based on lumping and we give a comparative analysis between them.

1 Introduction

1.1 Motivation

Homogeneous continuous-time Markov chains (we will refer to them as *Markov chains* for short) have established themselves as very powerful, yet fairly simple models for performance evaluation. A Markov chain (see e.g. [1–3]) is a finite-state continuous-time stochastic process of which the (stochastic) behavior in every state is completely independent of the prior states visited (i.e. the process satisfies the Markov property) and of the time already spent in the state (i.e. the process is homogeneous in time). It is known that, if some continuity requirement is met, a Markov chain can be represented as a directed graph in which

* Supported by Bsik-project BRICKS AFM 3.2.

** Supported by the Netherlands Organization for Scientific Research (NWO) project 612.064.205

nodes represent states and labels on the outgoing arrows determine the stochastic behavior in the state. Some states are marked as starting and have initial probabilities associated with them. For example, the behavior of the Markov chain depicted in Figure 1 is as follows. The process starts from state 1 with probability π and from state 2 with probability $1 - \pi$ (we do not depict the initial probability if it is zero). In state 1 it waits the amount of time determined by the minimum of two exponentially distributed delays, one parameterized with rate λ , the other with rate μ (note that this means that the process spends in state 1 exponentially distributed time with rate $\lambda + \mu$). After delaying the process jumps to state 2 or state 3 depending on which of the two delays was shorter. In these two states the process just stays forever, i.e. it is absorbed there.

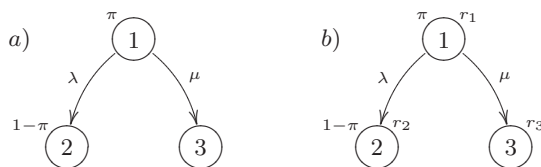

Fig. 1. a) A simple Markov chain and b) a Markov reward chain

To obtain some very useful performance measures, such as throughput and utilization of a system, Markov chains are often equipped with *rewards* (sometimes also called *costs*) [3]. There are many types of rewards but we consider only those that are associated to states. A (state) reward represents the gain of a Markov chain while residing in some state. A Markov chain with rewards is called a Markov reward chain (see Figure 1b).

A vast mathematical theory has been developed to support Markov chains (as well as Markov reward chains). Efficient methods are available to deal with Markov chains with millions of states making them very applicable in practice. One of the main issues when using Markov chains is to find a Markov chain that correctly represents the system being analyzed.

Over the past few years several performance modeling techniques have been developed to enable the compositional generation of Markov chains (and more recently also Markov reward chains), i.e. to provide ways to generate big Markov chains from smaller ones. Some of the best known techniques are stochastic process algebras [4, 5], (generalized) stochastic Petri nets [6–8], probabilistic I/O automata [9], stochastic automata networks [10], etc. Most of the formalisms first generate some intermediate models that are later used to derive pure Markov chains for performance measuring. Typically, these models are extensions of Markov chains with features to enable interaction between components. These features sometimes have undelayable behavior, i.e. they are instantaneous. In the literature instantaneous transitions are referred to as internal or silent steps (in process algebra) or as immediate transitions (in Petri nets). In a typical deriva-

tion of a Markov chain all action information is discarded and instantaneous transitions are eliminated. We illustrate this approach in the fields of stochastic process algebra and Petri nets.

Stochastic process algebras are process algebras that include features for the modeling of exponentially distributed delays (e.g. [4, 5]). Stochastic information is generally introduced in one of two ways: by adding a delay parameter to actions, like e.g. in PEPA [5], or by adding delays as separate constructs, like e.g. in Interactive Markov Chains [4]. In the later case silent transitions play a prominent role.

In the case of Interactive Markov Chains the underlying Markov chain is obtained as follows. Under the assumption that system does not interact with the environment any longer, all action information can be discarded and the action labeled transitions are transformed into internal τ -transitions. These transitions are considered instantaneous and choices between them are made non-deterministically. To obtain a pure Markov chain τ -transitions are eliminated (if possible) by using a relation on transition systems called weak bisimulation, which is a combination of the standard weak bisimulation for transition systems [11] and of the aggregation method for Markov chains called ordinary lumping [12–14]. This weak bisimulation always gives priority to τ -transitions over exponential delays based on the intuitive fact that these transitions are instantaneous. If there are closed loops of τ -transitions, then the model is considered ill-defined (here ‘closed’ means that there is no exit from the loop with a τ -transition). We give an example of a reduction modulo this weak bisimulation.

Example 1. Consider the Interactive Markov chain depicted in Figure 2a. If we assume that the system is closed, i.e. that it does not interact with the environment, then the actions **a** and **b** can be renamed into the instantaneous transition τ and an equivalent model is obtained. The intermediate model, consisting entirely of internal transitions and rates, is depicted in Figure 2b. Now, assume that the process in Figure 2b starts from state 1. There it exhibits a classical non-determinism, i.e. the probability of taking the τ -transitions is undetermined. However, if we observe the behaviors in states 2 and 3, we notice that they are the same. No matter which transition is taken from state 1, after performing a τ -transition and delaying exponentially with rate λ , the process enters state 4. As τ -transitions are timeless, the process in b) is equivalent to the Markov chain in c) according to weak bisimulation equivalence.

Generalized stochastic Petri nets are introduced in [6] to enable performance modeling using Petri nets. A Petri net [15] is a bipartite graph with two sets of nodes: places and transitions. Input arcs connect places with transitions and output arcs connect transitions with places. Each place can contain several tokens. A so-called marking represents the configuration of the tokens in the places. A transition is enabled if there are tokens in all places that have an input arc to the transition. Each transition in a generalized stochastic Petri net has a so-called firing time, which can be zero (for immediate transitions) or exponentially distributed (for timed transitions). If a marking enables some immediate transition, then the marking is called vanishing. The process described by a generalized

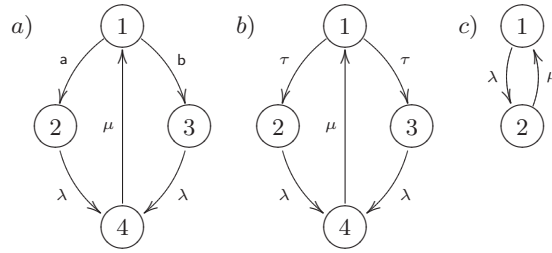

Fig. 2. An a) Interactive Markov chain, b) the intermediate model with τ -transitions and c) the induced Markov chain.

stochastic Petri net is captured by a so-called extended reachability graph that represents the particular intermediate model and that can be further reduced to a Markov chain [15, 6, 7]. Of interest are the vanishing markings which exist in the extended reachability graph, but are eliminated to give the resulting Markov chain. It is common to assume that immediate transitions cannot form closed loops, i.e. these loops are considered illegal. Also, usually it is required to know the firing probabilities of multiple enabled immediate transitions [7]. A typical elimination of vanishing markings is given in Example 2.

Example 2. Figure 3 depicts a generalized stochastic Petri net with its corresponding reachability graph and the underlying Markov chain. The graph contains the markings of the only token placed initially in p_1 . The vanishing place is p_2 (thus, the vanishing marking is 0100) because of the enabled immediate transitions t_2 and t_3 with probabilities p and $1 - p$. In the derived Markov chain the probabilities of the vanishing place split the normal rate λ into two rates $p\lambda$ and $(1 - p)\lambda$ that reach the final places p_3 and p_4 , respectively.

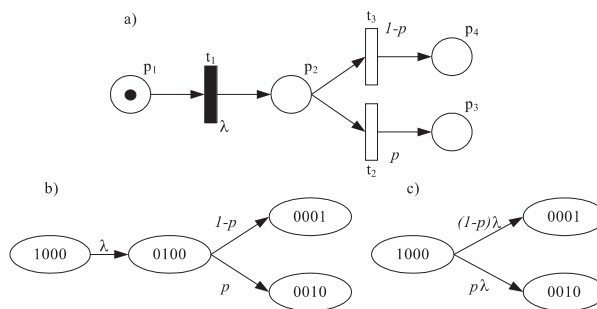

Fig. 3. a) A generalized stochastic Petri net, b) the corresponding extended reachability graph and c) the derived Markov chain.

Note that the intermediate performance models from Figure 2b and Figure 3b are not defined as stochastic processes. This makes it impossible to claim that the original model and the underlying Markov chain have the same performance. The reduction technique of stochastic Petri nets has been (stochastically) formalized in [16] by treating the reachability graphs as discontinuous Markov chains [17] and eliminating the vanishing places by the aggregation approach of [18, 19]. However, this method is only possible when immediate transitions are probabilistic, and the same method can not be directly applied in the case when they are non-deterministic (such as those in Figure 2b).

In this part we give a mathematical underpinning of the elimination of both, probabilistic and non-deterministic, types of instantaneous transitions in the above extensions to Markov (reward) chains. We define two methods of aggregation that abstract away from these transitions while preserving performance measures. The first method is based on lumping, i.e. joining states with equivalent behavior into classes. With this method we can formalize the intuition behind the variant of weak bisimulation used in [4], but also point out to some subtle differences. Our method, unknown before in the setting with probabilistic instantaneous transitions, leads to some new aggregation procedures here. The second method is an extension of [18] (and therefore also of [16]). It is based on the elimination of stochastic discontinuity that arises from having instantaneous probabilistic transitions. The method is very common, often applied in perturbation theory, and this motivated us to extend it and adapt it to the setting with nondeterminism. By discussing both methods in a common framework, we are able to compare them. We show that, although quite incomparable in the setting with probabilistic instantaneous transitions, in the non-deterministic setting the two approaches coincide.

In this text we do not provide any algorithms nor real world examples. Algorithms will be considered in future work. Since our main contribution is the theory of elimination of instantaneous states coming from standard Markovian models, examples where our results can be applied are found elsewhere. However, still in the absence of tooling, we cannot apply them in big case studies. This is not a serious drawback. One of our results is that, the lumping method in the non-deterministic setting only differs from the weak bisimulation reduction method from [4], in cases that we think will not appear in real world examples (e.g., closed τ -loops which indicate that there is divergence in the system). This implies that the tooling for Interactive Markov chains is suitable for our setting as well.

1.2 Our setting

Our approach to the problem is as follows.

Extensions of the Markov reward chain model To model probabilistic instantaneous transitions the standard Markov reward chain model is extended to have some transitions (linearly) parameterized with a real variable τ (implicitly assumed to be large). This extension of Markov reward chains is referred to as

Markov reward chains with fast transitions. The intuition comes from the semantics of Markov chains. If there are (fast) transitions $a\tau$ and $b\tau$ leading from some state, then the probability of taking $a\tau$ (resp. $b\tau$) from this state is $\frac{a}{a+b}$ (resp. $\frac{b}{a+b}$). Therefore, the numbers a and b , called *speeds*, completely determine the probabilities of state changes. We mathematically formalize the idea that fast transitions take zero time by considering the limit process as τ goes to infinity (the term “speed” now has a point). The intuition again comes from the semantics of Markov chains. The expected time the process spends in some state with e.g. only $a\tau$ and λ leading from it is $\frac{1}{a\tau+\lambda}$ which goes to 0 when τ goes to infinity. The limit process may do infinitely many transitions in a finite amount of time, i.e. may be stochastically discontinuous [17, 19]. This model is often considered pathological in literature but, as shown in [19, 16], it is very useful for explanation of results. We also use it to justify the operations on Markov reward chains with fast transitions. A Markov reward chain with stochastic discontinuity is called a *discontinuous Markov reward chain*. Next, we introduce *Markov reward chains with silent transitions* as classes of Markov reward chains with fast transitions that all have the same structure, but different speeds assigned to the fast transitions. Thus, a silent transition is a fast transition with unspecified probability with which it can be chosen. This is our way of modeling non-deterministic behavior in Markov chains.

For each extension, we introduce two aggregation methods.

Aggregation by Lumping The first aggregation method is based on lumping, i.e. on joining all states that exhibit the same behavior into classes. We decided to consider the lumping method not only because it is the most common method for aggregation of standard Markov chains but also because it allows us to formalize the intuitive ideas behind weak bisimulation for Interactive Markov chains. Extending the notion of ordinary lumping for Markov reward chains, we define a notion of lumping for discontinuous Markov reward chains. Based on that, we define a notion of lumping for Markov reward chains with fast transitions, called τ -lumping. We justify the latter notion by showing that the following diagram commutes:

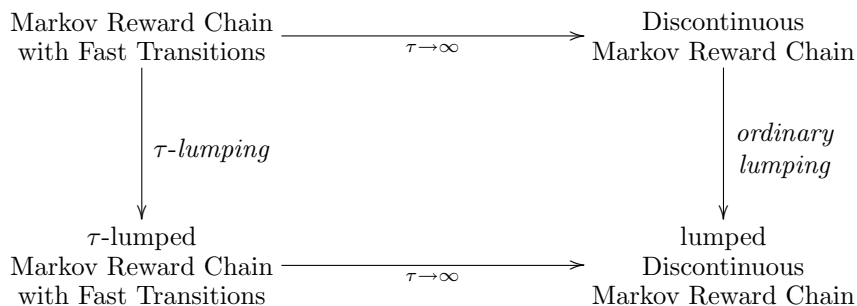

Next, we define a notion of lumping, called τ_{\sim} -lumping, for Markov reward chains with silent transitions, and show that it is a proper lifting of τ -lumping to equivalence classes of Markov reward chains with fast transitions. In other

words, we show that τ_{\sim} -lumping induces a τ -lumping for each element of the class and moreover, that the induced τ -lumped process does not depend on the representative from the class. That is, we show that the following diagram commutes:

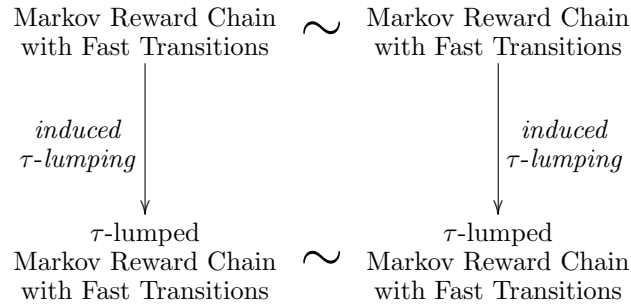

Aggregation by Reduction It is straightforward to obtain (for example, by comparison of the matrix manipulation in [7, 20]) that the methods for elimination of vanishing markings in generalized stochastic Petri nets given in [7, 8, 15, 6, 20] are equivalent to the reduction method in perturbation theory (cf. [19, 21]) for elimination of stochastic discontinuity, restricted to some specific cases, where all ergodic classes (i.e. closed loops of instantaneous transitions) have only one element. We recall the results from this setting that allow us reduce a discontinuous Markov chain to a Markov chain. Then we extend this technique to discontinuous Markov reward chains, Markov reward chains with fast transitions and Markov reward chains with silent transitions. The corresponding method for Markov reward chains with fast transitions is referred to as τ -reduction. The following diagram shows the structure of the method:

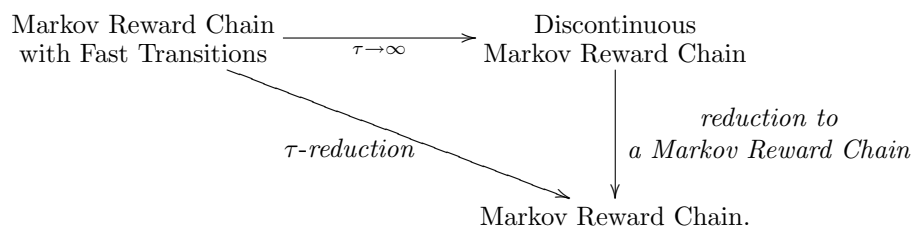

Subsequently, we extend the notion of τ -reduction to Markov reward chains with silent transitions by lifting it to equivalence classes of Markov reward chains with fast transitions. The new aggregation method is called τ_{\sim} -reduction. The main requirement for a process to be τ_{\sim} -reducible is that it τ -reduces to a speed

independent Markov chain. This is illustrated by the following:

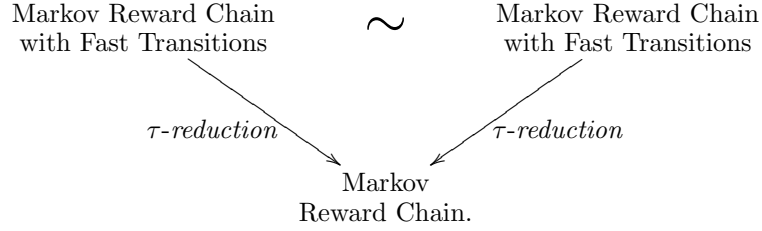

Motivated by the fact that τ_{\sim} -reduction in general does not aggregate much, we introduce a new concept, called *total τ_{\sim} -reduction*, that is a combination of τ -reduction and standard ordinary lumping on the τ -reduced representative Markov reward chain with fast transitions. The idea is to eliminate the effect of the speeds of fast transitions by lumping, and thus to aggregate more. The following diagram clarifies the structure of the method:

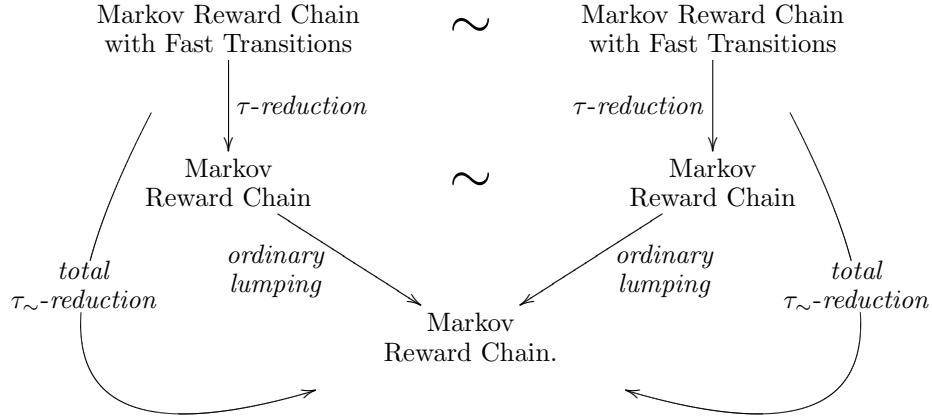

Comparison of the methods Each of the reduction methods is compared with its corresponding lumping method. We show that the reduction and the lumping methods for discontinuous Markov chains and Markov reward chains with fast transitions are incomparable but that the reduction method is superior, i.e. it aggregates more, if combined with standard lumping. We also show that, in case there are no silent transitions in the lumped process, τ_{\sim} -reduction is a special case of τ_{\sim} -lumping, and that τ_{\sim} -lumping coincides with total τ_{\sim} -reduction. Finally, we point out the differences between τ_{\sim} -lumping and the weak bisimulation for Interactive Markov chains.

1.3 Outline

The mentioned extensions to Markov chains, i.e. Markov reward chains, discontinuous Markov reward chains, Markov reward chains with fast transitions

and Markov reward chains with silent transitions, are introduced in Section 2, and necessary theorems are provided to establish the connections between them. In Section 3 we define the ordinary lumping for discontinuous Markov chains, and the notions of τ - and τ_{\sim} -lumping. In Section 4 we recall the reduction method for discontinuous Markov chains, extend it to discontinuous Markov reward chains, and define τ -, τ_{\sim} - and total τ_{\sim} -reductions. The lumping and the reduction method are compared in Section 5. For overlapping results we refer to our previous work [22].

2 Markov Reward Chains with Discontinuities, and with Fast and Silent Transitions

This section introduces several extensions of standard Markov chains. We first recall the definition of a discontinuous Markov chain from [17, 19], i.e. of a Markov chain that can also exhibit non-continuous behavior, and extend it with rewards. Next, the standard Markov chain model is extended by adding special transitions called fast transitions. As explained in the introduction, this is to model probabilistic transitions. We show that Markov reward chains with fast transitions are asymptotically equivalent to discontinuous Markov chain. Finally, to model nondeterminism we introduce Markov reward chains with silent transitions as Markov reward chains with fast transitions in which the speeds of fast transitions are unknown.

We give some preliminaries.

2.1 Preliminaries

All vectors are column vectors if not indicated otherwise. $\mathbf{1}^n$ denotes the vector of n 1's. $\mathbf{0}^{n \times m}$ denotes the $n \times m$ zero matrix. I^n denotes the $n \times n$ identity matrix. We omit the n and m when they are clear from the context. We write $A > 0$ (resp. $A \geq 0$) when all elements of a matrix A are greater than (resp. greater than or equal to) zero. A matrix $A \in \mathbb{R}^{n \times m}$ is called *stochastic* if $A \geq 0$ and $A \cdot \mathbf{1} = \mathbf{1}$. By $\text{diag}(A_1, \dots, A_n)$ we denote the block matrix with blocks A_1, \dots, A_n on the diagonal and $\mathbf{0}$'s elsewhere.

We will also use the notion of partitioning.

Definition 3 (Partitioning). *Let \mathcal{S} be a set. A set $\mathcal{P} = \{S_1, \dots, S_N\}$ of subsets of \mathcal{S} is called a partitioning of \mathcal{S} if $\mathcal{S} = S_1 \cup \dots \cup S_N$, $S_i \neq \emptyset$ and $S_i \cap S_j = \emptyset$ for all i, j , with $i \neq j$. The partitionings $\mathcal{P} = \{\mathcal{S}\}$ and $\mathcal{P} = \{\{i\} \mid i \in \mathcal{S}\}$ are called trivial.*

Given a set $\mathcal{S} = \{1, \dots, n\}$ and its partitioning $\mathcal{P} = \{S_1, \dots, S_N\}$, it is sometimes convenient to permute the elements of \mathcal{S} so that, for all $i, j \in \mathcal{S}$ and all $I, J \in \{1, \dots, N\}$, if $i \in S_I$, $j \in S_J$ and $I \leq J$, then $i \leq j$. Any such numbering of \mathcal{S} is called the numbering that makes the partitioning \mathcal{P} explicit.

2.2 Discontinuous Markov Reward Chains

The standard theory of Markov chains [1–3] assumes continuity, i.e. that the probability of the process occupying the same state at time t and time 0 when $t \rightarrow 0$ is 1. However, as pointed in [19], when working with instantaneous transitions we need to drop this requirement and work in the more general theory of discontinuous Markov chains introduced in [17]. In this section we give a definition in terms of matrices of the discontinuous Markov chains, following the approach of [19] but with the extension of an initial probability vector and rewards.

A discontinuous Markov chain is a time-homogeneous finite-state stochastic process that satisfies the Markov property. It is known (see [17, 2, 19]) that a discontinuous Markov chain with an ordered state space is completely determined by a *transition matrix function* (called its transition matrix function) and a stochastic *row* vector that gives the starting probabilities of the process for each state (called the *initial probability vector*).

Definition 4 (Transition matrix function). A function $P : \mathbb{R}_{>0} \mapsto \mathbb{R}^{n \times n}$, is called a transition matrix function iff, for all $t > 0$,

1. $P(t) \geq 0$,
2. $P(t) \cdot \mathbf{1} = \mathbf{1}$ and
3. $P(t+s) = P(t) \cdot P(s)$ for all $s > 0$.

If $\lim_{t \rightarrow 0} P(t)$ is equal to the identity matrix, then P is called continuous, otherwise it is discontinuous (it is shown in [1] that this limit always exists). For any $t > 0$, we call the image $P(t)$ a transition matrix. As is standard practice, when we say transition matrix $P(t) = \dots$ we actually mean transition matrix function P defined by $P(t) = \dots$.

Example 5. a. The matrix

$$P(t) = \begin{pmatrix} e^{-(\lambda+\mu)t} & \frac{\lambda}{\lambda+\mu}(1-e^{-(\lambda+\mu)t}) & \frac{\mu}{\lambda+\mu}(1-e^{-(\lambda+\mu)t}) & \\ 0 & 1 & 0 & \\ 0 & 0 & 0 & 1 \end{pmatrix},$$

with $\lambda, \mu \geq 0$ and $\lambda + \mu \neq 0$, is a transition matrix. It is continuous because clearly $\lim_{t \rightarrow 0} P(t) = I$.

b. Let $0 < p < 1$ and $\lambda \geq 0$. Then

$$P(t) = \begin{pmatrix} (1-p) \cdot e^{-p\lambda t} & p \cdot e^{-p\lambda t} & 1-e^{-p\lambda t} & \\ (1-p) \cdot e^{-p\lambda t} & p \cdot e^{-p\lambda t} & 1-e^{-p\lambda t} & \\ 0 & 0 & 1 & \end{pmatrix}$$

is a transition matrix. It is discontinuous because

$$\lim_{t \rightarrow 0} P(t) = \begin{pmatrix} 1-p & p & 0 \\ 1-p & p & 0 \\ 0 & 0 & 1 \end{pmatrix} \neq I.$$

The following theorem of [19, 23] gives a convenient characterization of a transition matrix that does not depend on t .

Theorem 6. *Let $(\Pi, Q) \in \mathbb{R}^{n \times n} \times \mathbb{R}^{n \times n}$ be such that:*

1. $\Pi \geq 0$, $\Pi \cdot \mathbf{1} = \mathbf{1}$, $\Pi^2 = \Pi$,
2. $\Pi Q = Q \Pi = Q$,
3. $Q \cdot \mathbf{1} = \mathbf{0}$ and
4. $Q + c\Pi \geq 0$ for some $c \geq 0$.

Then $P(t) = \Pi e^{Qt} = \Pi \sum_{n=0}^{\infty} \frac{Q^n t^n}{n!}$ is a transition matrix. Moreover, the converse also holds: For any transition matrix $P(t)$ there exists a unique pair (Π, Q) that satisfies Conditions 1–4 and such that $P(t) = \Pi e^{Qt}$.

Note that, $P(t) = \Pi e^{Qt}$ is continuous iff $\Pi = I$. In this case Q is a *generator* matrix, i.e. a square matrix of which the non-diagonal elements are non-negative and each diagonal element is the additive inverse of the sum of the non-diagonal elements of the same row.

Example 7. For the transition matrices $P(t)$ of Example 5a and 5b we obtain

- a. $\Pi = I$ and $Q = \begin{pmatrix} -(\lambda+\mu) & \lambda & \mu \\ 0 & 0 & 0 \\ 0 & 0 & 0 \end{pmatrix}$. Note that Q is a generator matrix.
- b. $\Pi = \begin{pmatrix} 1-p & p & 0 \\ 1-p & p & 0 \\ 0 & 0 & 1 \end{pmatrix}$ and $Q = \begin{pmatrix} -p(1-p)\lambda & -p^2\lambda & p\lambda \\ -p(1-p)\lambda & -p^2\lambda & p\lambda \\ 0 & 0 & 0 \end{pmatrix}$. Note that Π deviates from the identity matrix only in the first two rows. This is exactly where Q deviates from the form of a generator matrix.

Since the nature of the state space \mathcal{S} of a Markov chain is, in general, not important and only its ordering is (for the matrix representation), we will always implicitly assume that $\mathcal{S} = \{1, \dots, n\}$. Theorem 6 allows us then to identify a discontinuous Markov chain determined by a transition matrix $P(t) = \Pi e^{Qt} \in \mathbb{R}^{n \times n}$ and an initial probability vector $\sigma \in \mathbb{R}^{1 \times n}$ with the triple (σ, Π, Q) .

In the case when $\Pi = I$ the discontinuous Markov chain (σ, Π, Q) has no stochastic discontinuity and is a standard Markov chain. Since Q is then a generator matrix, the process has the standard visual representation (like in Figure 1).

It is a known result (see e.g. [19]) that in a discontinuous Markov chain (σ, Π, Q) , Π gets the following form after a suitable renumbering of the states:

$$\Pi = \begin{pmatrix} \Pi_1 & \mathbf{0} & \dots & \mathbf{0} & \mathbf{0} \\ \mathbf{0} & \Pi_2 & \dots & \mathbf{0} & \mathbf{0} \\ \vdots & \vdots & \ddots & \vdots & \vdots \\ \mathbf{0} & \mathbf{0} & \dots & \Pi_M & \mathbf{0} \\ \overline{\Pi}_1 & \overline{\Pi}_2 & \dots & \overline{\Pi}_M & \mathbf{0} \end{pmatrix}$$

where for all $1 \leq K \leq M$, $\Pi_K = \mathbf{1} \cdot \mu_K$ and $\bar{\Pi}_K = \delta_K \cdot \mu_K$ for a row vector $\mu_K > 0$ such that $\mu_K \cdot \mathbf{1} = 1$ and a vector $\delta_K \geq 0$ such that $\sum_{i=1}^M \delta_K = \mathbf{1}$. This numbering determines a partitioning $\mathcal{E} = \{E_1, \dots, E_M, T\}$ of $\mathcal{S} = \{1, \dots, n\}$ into *ergodic* classes, E_1, \dots, E_M , determined by Π_1, \dots, Π_M , and into a class of *transient* states, T , determined by $\bar{\Pi}_1, \dots, \bar{\Pi}_M$. The partitioning \mathcal{E} is called the *ergodic partitioning*. For every ergodic class E_K , the vector μ_K is the vector of *ergodic probabilities*. If an ergodic class E_K contains exactly one state, then called a *regular* state, we have $\mu_K = (1)$. The vector δ_K holds the *trapping probabilities* from transient states to the ergodic class E_K . Note that, although μ_K and δ_K are not indexed by $\{1, \dots, n\}$, without introducing confusion, we will always use the implicit indexing. In other words, for any $i \in E_K$, we will freely write $\mu_K[i]$ to refer to the element of μ_K that corresponds to state i . Similarly, we write $\delta_K[i]$ for any $i \in T$.

Let us now explain the behavior of a discontinuous Markov chain as given in [17, 19]. The discontinuous Markov chain (σ, Π, Q) starts in some state with a probability that is determined by the initial probability vector σ . In an ergodic class with multiple states the process spends a non-zero amount of time switching rapidly (infinitely many times) among its elements. The probability that it is found in some state of this class is determined by the vector of ergodic probabilities of this class. The time the process spends in the class is exponentially distributed and determined by the matrix Q . If the ergodic class contains only one state, i.e. if the process is in the regular state, then the row of Q corresponding to that state has the form of a row in a generator matrix, and $Q[i, j]$ for $i \neq j$ is interpreted as the rate from i to j . In a transient state the process spends no time (with probability one) and goes immediately to some ergodic class (and stays trapped there for some amount of time). Note that $\delta_K[i] > 0$ iff $i \in T$ can be trapped in the ergodic class E_K . A standard Markov chain is a discontinuous Markov chain that has no transient states and only has regular (ergodic) states.

Sometimes we will also work with the matrix Π that is not permuted to be in the above form, i.e. we will work in a numbering that does not make the ergodic partitioning explicit. Let us so explain the form of Π on the level of single elements. Note first that $\Pi[i, j] = 0$ for all $i \in \mathcal{S}$ and all $j \in T$. Next, note that if $i \in E_K$, $j \in E_L$ and $K \neq L$, then $\Pi[i, j] = 0$. If $K = L$, then we have $\Pi[i, j] > 0$ and $\Pi[i, j] = \Pi[k, j]$ for all $j \in E_K = E_L$. Note that for $i, j \in E_K$ we have $\Pi[i, j] = \mu_K[j]$. For transient states we have that if $i \in T$ and $j \in E_K$, then $\Pi[i, j] = \delta_{Ki} \cdot \Pi[k, j]$, $k \in E_K$, where δ_{Ki} is some number that satisfies $0 \leq \delta_{Ki} \leq 1$. Note that actually $\delta_{Ki} = \delta_K[i]$.

We give examples of some discontinuous Markov chains and their ergodic partitionings.

Example 8. We assume that σ is always some arbitrary stochastic row vector.

- a. The triple (σ, Π, Q) , where Π and Q are those from Example 7a, is a standard Markov chain because $\Pi = I$. The ergodic partitioning is $\mathcal{E} = \{E_1, E_2, E_3\}$ where $E_1 = \{1\}$, $E_2 = \{2\}$ and $E_3 = \{3\}$. For $\sigma = (\pi \ 1-\pi \ 0)$, this Markov chain is visualized in Figure 1a from the introduction.

- b. Let (σ, Π, Q) be a discontinuous Markov chain with Π and Q as in Example 7. This discontinuous Markov chain has two ergodic classes $E_1 = \{1, 2\}$ and $E_2 = \{3\}$ and no transient states. The corresponding ergodic probability vectors are $\mu_1 = (1-p \ p)$ and $\mu_2 = (1)$. In the first two states the process exhibits a discontinuous behavior. It constantly switches among those states and it is found in the first one with probability $1-p$ and in the second one with probability p . The amount of time the process spends switching is exponentially distributed with rate $p\lambda$ (we will see later how this follows from Q).
- c. Let, for $0 < p < 1$ and $\lambda, \mu, \nu > 0$, Π and Q be defined as:

$$\Pi = \begin{pmatrix} 0 & p & 1-p & 0 \\ 0 & 1 & 0 & 0 \\ 0 & 0 & 1 & 0 \\ 0 & 0 & 0 & 1 \end{pmatrix} \quad \text{and} \quad Q = \begin{pmatrix} 0 & -p\lambda & -(1-p)\mu & p\lambda + (1-p)\mu \\ 0 & -\lambda & 0 & \lambda \\ 0 & 0 & -\mu & \mu \\ \nu & 0 & 0 & -\nu \end{pmatrix}.$$

Its ergodic partitioning is $\mathcal{E} = \{E_1, E_2, E_3, T\}$ where $E_1 = \{2\}$, $E_2 = \{3\}$, $E_3 = \{4\}$ and $T = \{1\}$ (note that the numbering does not make the ergodic partitioning explicit since the transient state precedes the ergodic ones). We have $\mu_i = (1)$ for all $i = 1, 2, 3$, and $\delta_1 = (p)$, $\delta_2 = (1-p)$ and $\delta_3 = (0)$. If the process is in state 1, then with probability p it is trapped in state 2, the only state in the ergodic class E_1 , and with probability $1-p$ it is trapped in state 3, the only state in the ergodic class E_2 .

2.3 Adding rewards

We now add rewards to our model. A (state) reward is a number associated to a state that represents the gain of a process while in that state. We define a discontinuous Markov reward chain as a discontinuous Markov chain with an additional vector that holds a reward for each state.

Definition 9 (Markov Reward Process). A discontinuous Markov reward chain is a quadruple (σ, Π, Q, ρ) where (σ, Π, Q) is a discontinuous Markov chain and $\rho \in \mathbb{R}^{n \times 1}$ is the reward vector.

The *total reward* of the process up to time $t > 0$, denoted $R(t)$, is calculated as $R(t) = \sigma P(t)\rho$. The total reward remains unchanged if the reward vector ρ is replaced by $\Pi\rho$. To show this, note that $P(t) = P(t)\Pi$ (cf. [19]), so $\sigma P(t)\Pi\rho = \sigma P(t)\rho = R(t)$. Intuitively, the reward in a transient state can be replaced by the sum of the rewards of the ergodic states that it can be trapped in, and the reward of an ergodic state is the sum of the rewards of all states inside its ergodic class weighted according to their ergodic probabilities. We give an illustration in the following example.

Example 10. a. Let (σ, Π, Q, ρ) be a discontinuous Markov reward chain where (σ, Π, Q) is as in Example 8a and $\rho = (r_1 \ r_2 \ r_3)$. From Examples 5 and 7a

we first obtain the transition matrix

$$P(t) = \begin{pmatrix} e^{-(\lambda+\mu)t} & \frac{\lambda}{\lambda+\mu}(1-e^{-(\lambda+\mu)t}) & \frac{\mu}{\lambda+\mu}(1-e^{-(\lambda+\mu)t}) \\ 0 & 1 & 0 \\ 0 & 0 & 1 \end{pmatrix}.$$

Then, we calculate the total reward:

$$\begin{aligned} R(t) &= \sigma P(t) \rho = (1 \ 0 \ 0) P(t) \begin{pmatrix} r_1 \\ r_2 \\ r_3 \end{pmatrix} = \\ &= r_1 e^{-(\lambda+\mu)t} + \frac{\lambda r_2 + \mu r_3}{\lambda + \mu} (1 - e^{-(\lambda+\mu)t}). \end{aligned}$$

- b. Let (σ, Π, Q) be the discontinuous Markov chain from Example 8b and let $\rho = (r_1 \ r_2 \ r_3)$. The transition matrix is obtained from Examples 5 and 7b. The total reward of the discontinuous Markov reward chain (σ, Π, Q, ρ) is:

$$R(t) = \sigma P(t) \rho = ((1-p)r_1 + pr_2 - r_3) e^{-p\lambda t} + r_3.$$

The same total reward is obtained when ρ is replaced by the reward vector $\rho' = \Pi \rho = \begin{pmatrix} (1-p)r_1 + pr_2 \\ (1-p)r_1 + pr_2 \\ r_3 \end{pmatrix}$. Note that the first two elements of ρ' are equal.

This is because these two states belong to the same ergodic class.

- c. Let (σ, Π, Q) be the discontinuous Markov chain from Example 8c and let $\rho = (r_1 \ r_2 \ r_3 \ r_4)$. The total reward of the discontinuous Markov reward chain (σ, Π, Q, ρ) does not depend on r_1 . This is because state 1 is a transient state; the process spends no time there nor does it ever come back to it, so no reward is gained. This is confirmed when ρ is replaced by $\rho' = \Pi \rho = \begin{pmatrix} pr_2 + (1-p)r_3 \\ r_2 \\ r_3 \\ r_4 \end{pmatrix}$.

2.4 Markov Reward Chain with Fast Transitions

We extend the standard Markov chain model by letting Markov chains contain two types of transitions, slow and fast. The behavior of a Markov reward chain with fast transitions is determined by a pair of generator matrices: the first matrix represents the normal (slow) transitions, whereas the second represents the (*speed* of) fast transitions. The role of speeds is to determine the probabilistic behavior in a state.

Definition 11 (Markov reward chain with fast transitions). *The Markov reward chain with fast transitions determined by a stochastic row vector $\sigma \in \mathbb{R}^{1 \times n}$, generator matrices $Q_s, Q_f \in \mathbb{R}^{n \times n}$ and a vector $\rho \in \mathbb{R}^{n \times 1}$, denoted (σ, Q_s, Q_f, ρ) , is a function that assigns to each $\tau > 0$ the Markov reward chain $(\sigma, I, Q_s + \tau Q_f, \rho)$.*

We depict a Markov reward chain with fast transitions (σ, Q_s, Q_f, ρ) as the corresponding Markov reward chain $(\sigma, I, Q_s + \tau Q_f, \rho)$ (see Figure 4).

The following theorem shows that when $\tau \rightarrow \infty$, i.e. when fast transitions become instantaneous, a Markov reward chain with fast transitions behaves as a discontinuous Markov reward chain.

Theorem 12 (Limit process). *Let $P_\tau(t) = e^{(Q_s + \tau Q_f)t}$. Then, for all $t > 0$,*

$$\lim_{\tau \rightarrow \infty} P_\tau(t) = \Pi e^{Qt}$$

where $\Pi = \lim_{t \rightarrow \infty} e^{Q_s t}$ and $Q = \Pi Q_s \Pi$. In addition, Π and Q satisfy Conditions 1–4 of Theorem 6.

Proof. See [24] for the first proof, or [25] for a proof written in more modern terms. See [19] for the proof that convergence is also uniform.

Remark 13. We note that in perturbation theory the parametrization is usually done on the slow transitions with a small variable ε [19]. Afterwards the process is considered in timescale t/ε , as $\varepsilon \rightarrow 0$, where the normal transitions of the perturbed process behave as instantaneous transitions with known probabilities and the Markov chain exhibits stochastic discontinuity. In any case, both approaches are equivalent and give equal limit processes.

If Q is a generator matrix, then $\Pi = \lim_{t \rightarrow \infty} e^{Qt}$ is called the *ergodic projection* of Q . It is proven in [1] that the limit always exists; moreover it is known (see [26] for example) that Π is actually the unique matrix that satisfies the following:

$$\Pi \geq 0, \Pi \cdot \mathbf{1} = \mathbf{1}, \Pi^2 = \Pi, \Pi Q = Q \Pi = \mathbf{0} \text{ and } \text{rank}(\Pi) + \text{rank}(Q) = n.$$

Theorem 12 shows that the behavior of a Markov reward chain with fast transitions in the limit depends only on the ergodic projection of the matrix that models fast transitions and not on the matrix itself.

We say that the discontinuous Markov chain $(\sigma, \Pi, Q, \Pi \rho)$ is the *limit* of (σ, Q_s, Q_f, ρ) as $\tau \rightarrow \infty$, and indicate that by writing $(\sigma, Q_s, Q_f, \rho) \rightarrow_\infty (\sigma, \Pi, Q, \Pi \rho)$. The initial probability vector and the reward vector are not affected when $\tau \rightarrow \infty$ but it is convenient to replace the reward vector ρ by $\Pi \rho$ because of the facilitated representation of the lumping conditions in the following sections.

The ergodic partitioning of $(\sigma, \Pi, Q, \Pi \rho)$ is also said to be the ergodic partitioning of (σ, Q_s, Q_f, ρ) . However, it is known that the ergodic partitioning corresponds to the partitioning induced by closed communicating classes of fast transitions. We write $i \rightarrow j$ if $Q_f[i, j] > 0$, i.e. if there is a direct fast transition from i to j . Let \rightarrow denote the reflexive-transitive closure of \rightarrow . If $i \rightarrow j$ we say that j is τ -reachable from i . If $i \rightarrow j$ and $j \rightarrow i$ we say that i and j τ -communicate and write $i \rightleftarrows j$. In a slightly different context, it has been shown (see e.g. [1]) that every ergodic class is actually a closed class of τ -communicating states, closed meaning that for all i inside the class there does not exist j outside the class such that $i \rightarrow j$. Moreover, for some ergodic state j , $i \rightarrow j$ iff $\Pi[i, j] > 0$.

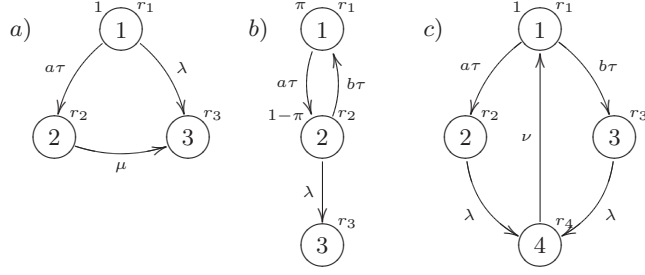

Fig. 4. Markov reward chains with fast transitions from Example 14

Example 14. a. Consider the Markov reward chain with fast transitions (σ, Q_s, Q_f, ρ) depicted in Figure 4a. It is defined with

$$\sigma = (1 \ 0 \ 0), \quad Q_s = \begin{pmatrix} -\lambda & 0 & \lambda \\ 0 & -\mu & \mu \\ 0 & 0 & 0 \end{pmatrix}, \quad Q_f = \begin{pmatrix} -a & a & 0 \\ 0 & 0 & 0 \\ 0 & 0 & 0 \end{pmatrix} \quad \text{and} \quad \rho = \begin{pmatrix} r_1 \\ r_2 \\ r_3 \end{pmatrix}.$$

The transition from state 1 to state 2 is fast and has speed a . The other two transitions are normal (slow).

The limit of (σ, Q_s, Q_f, ρ) is obtained as follows:

$$\Pi = \lim_{t \rightarrow \infty} e^{Q_f t} = \begin{pmatrix} 0 & 1 & 0 \\ 0 & 1 & 0 \\ 0 & 0 & 1 \end{pmatrix},$$

$$Q = \Pi Q_s \Pi = \begin{pmatrix} 0 & -\mu & \mu \\ 0 & -\mu & \mu \\ 0 & 0 & 0 \end{pmatrix} \quad \text{and} \quad \Pi \rho = \begin{pmatrix} r_2 \\ r_2 \\ r_3 \end{pmatrix}.$$

The ergodic partitioning is $E_1 = \{2\}$, $E_2 = \{3\}$ and $T = \{1\}$. This is because, as we see it in Figure 4a, state 2 and state 3 each form a trivial τ -communicating class.

- b. Consider the Markov reward chain with fast transitions depicted in Figure 4b. The limit of this Markov reward chain with fast transitions is the discontinuous Markov chain (σ, Π, Q, ρ') from Example 10b (with $p = \frac{a}{a+b}$). From Figure 4b we can easily see that the process has two closed τ -communicating classes, i.e. two ergodic classes $E_1 = \{1, 2\}$ and $E_2 = \{3\}$, and no transient states. This is confirmed by Example 10b.
- c. The limit of the Markov reward chain with fast transitions in Figure 4c is the discontinuous Markov chain (σ, Π, Q, ρ') of Example 10c (when $p = \frac{a}{a+b}$ and $\lambda = \mu$). From Figure 4c we obtain that the ergodic partitioning is determined by $E_1 = \{1\}$, $E_2 = \{2\}$, $E_3 = \{3\}$ and $T = \{4\}$. This is confirmed by Example 10c.

2.5 Markov Reward Chains with Silent Transitions

In this section we define discontinuous Markov reward chains that can exhibit nondeterministic behavior and call them Markov reward chains with silent transitions. A Markov reward chain with silent transitions is a Markov reward chain with fast transitions in which the speeds of the fast transitions are considered unspecified. In other words, we define a Markov reward chain with silent transitions by abstracting from the speeds in a Markov reward chain with fast transitions. For this, we need to introduce a special equivalence relation on matrices.

Definition 15 (Matrix grammar). *Two matrices $A, B \in \mathbb{R}^{n \times n}$ are said to have the same grammar, denoted by $A \sim B$, if for all $1 \leq i, j \leq n$, $A[i, j] = 0$ iff $B[i, j] = 0$.*

Example 16. For $a, b, c \neq 0$, the matrices $\begin{pmatrix} a & a \\ b & 0 \end{pmatrix}$ and $\begin{pmatrix} a & b \\ c & 0 \end{pmatrix}$ have the same grammar while the matrices $\begin{pmatrix} a & a \\ b & 0 \end{pmatrix}$ and $\begin{pmatrix} a & 0 \\ c & 0 \end{pmatrix}$ do not.

The abstraction from speeds is achieved by identifying generator matrices with the same grammar. A Markov reward chain with silent transitions is defined as a Markov reward chain with fast transitions but instead of one matrix that models fast transitions we take the whole equivalence class induced by \sim . Note that we do not take elements of the matrix to be sets, but rather take the set of matrices instead. The consequence is that a Markov reward chain with silent transitions is not allowed to choose different speeds each time it enters some state. Our approach to resolving nondeterminism therefore corresponds to the one of probabilistic, history independent, schedulers [27]. Having the quantification inside a matrix would lead to a much more complicated theory because it would force us to move from Markov chains to a model similar to *Markov set chains* [28].

Definition 17 (Markov reward chain with silent transitions). *A Markov reward chain with silent transitions is a quadruple $(\sigma, Q_s, [Q_f]_{\sim}, \rho)$ where (σ, Q_s, Q_f, ρ) is a Markov reward chain with fast transitions.*

A Markov reward chain with silent transitions $(\sigma, Q_s, [Q_f]_{\sim}, \rho)$ is visualized as the Markov reward chain with fast transitions (σ, Q_s, Q_f, ρ) but omitting the speeds of fast transitions. Figure 5 shows the Markov reward chains with silent transitions that correspond to the Markov reward chains with fast transitions from Figure 4.

Note that the notions of τ -reachability, τ -communication and ergodic partitioning are speed independent, so they naturally carry over to Markov reward chains with silent transitions.

3 Aggregation by Lumping

Lumping [12, 14, 13] is an aggregation method based on joining together states that exhibit equivalent behavior. In this section we introduce a notion of lumping

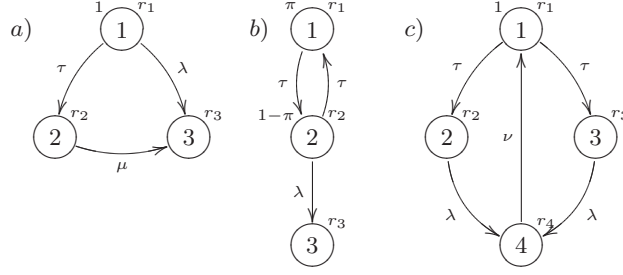

Fig. 5. Markov reward chains with silent transitions corresponding to the Markov reward chains with fast transitions from Figure 4

for each of the Markovian models from section 2. We first generalize the *ordinary lumping* method from standard Markov chains to discontinuous Markov reward chains. Then we introduce a lumping method for Markov reward chains with fast transitions, called τ -*lumping*, that assures that the limit process of the lumped Markov reward chain with fast transitions is the lumped version of the limit process of the original Markov reward chain with fast transitions. Finally, we lift τ -lumping to Markov reward chains with silent transitions and call it τ_{\sim} -*lumping*. We show that τ_{\sim} -lumping induces a τ -lumping for all possible speeds of fast transitions and, moreover, that the slow transitions in the τ -lumped process do not depend on those speeds.

3.1 Ordinary Lumping

Partitioning is a central notion in the definition of lumping, so recall Definition 3. To define lumping in matrix terms it is standard to associate, with every partitioning $\mathcal{P} = \{C_1, \dots, C_N\}$ of $\mathcal{S} = \{1, \dots, n\}$, the following two matrices. A matrix $V \in \mathbb{R}^{n \times N}$ defined as

$$V[i, j] = \begin{cases} 0, & i \notin C_j \\ 1, & i \in C_j \end{cases}$$

is called the *collector* matrix for \mathcal{P} . Its j -th column has 1's for elements corresponding to states in C_j and has zeroes otherwise. Note that $V \cdot \mathbf{1} = \mathbf{1}$. For the trivial partitionings $\mathcal{P} = \{\mathcal{S}\}$ and $\mathcal{P} = \{\{i\} \mid i \in \mathcal{S}\}$, we have $V = \mathbf{1}$ and $V = I$ respectively.

A matrix $U \in \mathbb{R}^{N \times n}$ such that $U \geq 0$ and $UV = I^{N \times N}$ is a *distributor* matrix for \mathcal{P} . It can be readily seen that to satisfy these conditions U must actually be a matrix of which the elements of the i -th row that correspond to elements in C_i sum up to one while the other elements of the row are 0. For the trivial partitioning $\mathcal{P} = \{\mathcal{S}\}$ a distributor is a vector with elements that sum up to 1; for the trivial partitioning $\mathcal{P} = \{\{i\} \mid i \in \mathcal{S}\}$ there exists only one distributor, viz. I .

Example 18. Let $\mathcal{S} = \{1, 2, 3\}$ and $\mathcal{P} = \{\{1, 2\}, \{3\}\}$. Then $V = \begin{pmatrix} 1 & 0 \\ 1 & 0 \\ 0 & 1 \end{pmatrix}$ is the collector for \mathcal{P} and $U = \begin{pmatrix} \frac{1}{3} & \frac{2}{3} & 0 \\ 0 & 0 & 1 \end{pmatrix}$ is an example for a distributor.

Aggregation by ordinary lumping partitions the state space into classes such that the process in the states that are lumped together behaves in the same way when transiting to other partitioning classes of states. It is also required that states in the same lumping class have the same reward. We formalize this in matrix terms.

Definition 19 (Ordinary lumping). *A partitioning \mathcal{P} of $\{1, \dots, n\}$ is called an ordinary lumping of a discontinuous Markov reward chain (σ, Π, Q, ρ) iff the following conditions hold:*

$$VU\Pi V = \Pi V, \quad VUQV = QV \quad \text{and} \quad VU\rho = \rho,$$

where V and U are respectively the collector and some distributor matrix for \mathcal{P} .

The lumping conditions only assure that the rows of ΠV (resp. QV and ρ) that correspond to the states of the same partitioning class are equal. The representation of these conditions in terms of a distributor matrix is just more convenient in applications. We show that, indeed, these conditions do not depend on the particular choice of the non-zero elements of U . Suppose that $VU\Pi V = \Pi V$ and that $U' \geq 0$ is such that $U'V = I$. Then $VU'\Pi V = VU'VU\Pi V = \Pi V$. Similarly, $VU'QV = QV$ and $VU'\rho = \rho$.

The trivial partitioning $\mathcal{P} = \{\{1\}, \dots, \{n\}\}$ is always an ordinary lumping. The other trivial partitioning $\mathcal{P} = \{S\}$, however, is an ordinary lumping only if the reward structure is trivial, i.e. if the reward vector ρ is comprised of equal elements.

The following theorem characterizes the lumped process, i.e. the process obtained after the aggregation by lumping.

Theorem 20 (Lumped process). *Let (σ, Π, Q, ρ) be a discontinuous Markov reward chain and let $\mathcal{P} = \{C_1, \dots, C_N\}$ be an ordinary lumping of (σ, Π, Q, ρ) . Define*

$$\hat{\sigma} = \sigma V, \quad \hat{\Pi} = U\Pi V, \quad \hat{Q} = UQV \quad \text{and} \quad \hat{\rho} = U\rho.$$

Then $(\hat{\sigma}, \hat{\Pi}, \hat{Q}, \hat{\rho})$ is a discontinuous Markov reward chain.

Proof. See [22].

When the lumping conditions hold the definition of $(\hat{\sigma}, \hat{\Pi}, \hat{Q}, \hat{\rho})$ also does not depend on a particular distributor U . To show this, let U' be another distributor matrix for \mathcal{P} . Then $U'\Pi V = U'VU\Pi V = U\Pi V$. Similarly, $U'QV = UQV$ and $U'\rho = U\rho$.

The trivial partitioning $\mathcal{P} = \{\{1\}, \dots, \{n\}\}$ leaves the original process intact. The other trivial partitioning, i.e. $\mathcal{P} = \{S\}$ gives the absorbing, one state, process as the result.

If \mathcal{P} is an ordinary lumping of (σ, Π, Q, ρ) and $\hat{\sigma}, \hat{\Pi}, \hat{Q}$ and $\hat{\rho}$ are defined as in Theorem 20, then we say that (σ, Π, Q, ρ) *lumps to* $(\hat{\sigma}, \hat{\Pi}, \hat{Q}, \hat{\rho})$ with respect to \mathcal{P} and we write $(\sigma, \Pi, Q, \rho) \rightarrow_{\mathcal{P}} (\hat{\sigma}, \hat{\Pi}, \hat{Q}, \hat{\rho})$.

Note that if (σ, Π, Q, ρ) is a Markov reward chain, then $VU\Pi V = \Pi V$ always holds. Moreover, in this case, $\hat{\Pi} = U\Pi V = UIV = I$ and so, by Theorem 6, \hat{Q} is a generator matrix. Therefore, when restricted to the continuous case, our notion of ordinary lumping coincides with the standard definition proposed in [13].

Before we give some examples of ordinary lumping we show that the definition of the lumped process is correct according to the standard probabilistic intuition. We need to show that the finite distribution of the lumped process, is the same as the sum of the finite distributions of the original process over the states in the lumping classes. That is, we need to prove that the probability that the process is in a finite sequence of classes in a given sequence of time instances, is the same as the sum of the probabilities that the process is in the individual sequences of states from these classes in that time sequence. We only give two theorems from which this easily follows (e.g. by induction on the length of the time sequence). We prove a lemma first.

Lemma 21. *Let (σ, Π, Q, ρ) be a discontinuous Markov reward chain and let \mathcal{P} be an ordinary lumping. Then,*

1. $\Pi Q^n = Q^n$ for all $n \geq 1$,
2. $VUQ^n V = Q^n V$ for all $n \geq 0$, and
3. $(UQV)^n = UQ^n V$ for all $n \geq 0$.

Proof. See [22].

The first theorem reflects the conditions of Definition 19 to the corresponding transition matrix.

Theorem 22. *Let (σ, Π, Q, ρ) be a discontinuous Markov reward chain and let $P(t) = \Pi e^{Qt}$ ($t > 0$), be its transition matrix. Let \mathcal{P} be an ordinary lumping of (σ, Π, Q, ρ) . Then*

$$VUP(t)V = P(t)V.$$

Proof. See [22].

The second theorem shows that the transition matrix of the lumped process can also be obtained directly from the transition matrix of the original process.

Theorem 23. *Let $(\sigma, \Pi, Q, \rho) \rightarrow_{\mathcal{P}} (\hat{\sigma}, \hat{\Pi}, \hat{Q}, \hat{\rho})$. Let $P(t) = \Pi e^{Qt}$ and $\hat{P}(t) = \hat{\Pi} e^{\hat{Q}t}$ ($t > 0$) be the transition matrices of (σ, Π, Q, ρ) and $(\hat{\sigma}, \hat{\Pi}, \hat{Q}, \hat{\rho})$ respectively. Then*

$$\hat{P}(t) = UP(t)V.$$

Proof. See [22].

Now we can also prove that the lumped process has the same total reward as the original process. Since the total reward is usually the most important performance measure, this is a very important property of lumping.

Corollary 24. Let $(\sigma, \Pi, Q, \rho) \rightarrow_{\mathcal{P}} (\hat{\sigma}, \hat{\Pi}, \hat{Q}, \hat{\rho})$ and let $R(t)$ and $\hat{R}(t)$ be the total reward of (σ, Π, Q, ρ) and $(\hat{\sigma}, \hat{\Pi}, \hat{Q}, \hat{\rho})$ respectively. Then $\hat{R}(t) = R(t)$.

Proof. Using Theorems 23 and 22, we have

$$\hat{R}(t) = \hat{\sigma} \hat{P}(t) \hat{\rho} = \sigma V U P(t) V U \rho = \sigma P(t) V U \rho = \sigma P(t) \rho = R(t).$$

We now give some examples.

Example 25. a. Let (σ, Π, Q, ρ) be the discontinuous Markov reward chain from Example 10a but with $r_2 = r_3 \stackrel{\text{def}}{=} r$. We show that the partitioning $\mathcal{P} = \{\{1\}, \{2, 3\}\}$ is an ordinary lumping. Recall that

$$\sigma = (\pi \ 1 - \pi \ 0), \quad \Pi = I, \quad Q = \begin{pmatrix} -(\lambda + \mu) & \lambda & \mu \\ 0 & 0 & 0 \\ 0 & 0 & 0 \end{pmatrix}, \quad \text{and } \rho = \begin{pmatrix} r_1 \\ r \\ r \end{pmatrix}.$$

From \mathcal{P} we obtain

$$V = \begin{pmatrix} 1 & 0 \\ 0 & 1 \\ 0 & 1 \end{pmatrix} \quad \text{and} \quad U = \begin{pmatrix} 1 & 0 & 0 \\ 0 & \alpha & 1 - \alpha \end{pmatrix},$$

for some $0 \leq \alpha \leq 1$. Now, we have

$$V U Q V = \begin{pmatrix} -(\lambda + \mu) & \lambda + \mu \\ 0 & 0 \end{pmatrix} = Q V$$

and

$$V U \rho = \begin{pmatrix} r_1 \\ \alpha r + (1 - \alpha)r \\ \alpha r + (1 - \alpha)r \end{pmatrix} = \begin{pmatrix} r_1 \\ r \\ r \end{pmatrix} = \rho.$$

The lumped process $(\hat{\sigma}, \hat{\Pi}, \hat{Q}, \hat{\rho})$ is defined by

$$\hat{\sigma} = (1 \ 0), \quad \hat{\Pi} = I, \quad \hat{Q} = \begin{pmatrix} -(\lambda + \mu) & \lambda + \mu \\ 0 & 0 \end{pmatrix} \quad \text{and} \quad \hat{\rho} = \begin{pmatrix} r_1 \\ r \end{pmatrix}.$$

The total reward of the process (σ, Π, Q, ρ) from Example 10a reduces to $R(t) = r_1 e^{-(\lambda + \mu)t} + r(1 - e^{-(\lambda + \mu)t})$ when $r_2 = r_3 = r$. As proven in Corollary 24, the same total reward can be calculated by

$$\begin{aligned} \hat{\sigma} \hat{P}(t) \hat{\rho} &= \hat{\sigma} e^{\hat{Q}t} \hat{\rho} = (1 \ 0) \begin{pmatrix} e^{-(\lambda + \mu)t} & 1 - e^{-(\lambda + \mu)t} \\ 0 & 1 \end{pmatrix} \begin{pmatrix} r_1 \\ r \end{pmatrix} = \\ &= r_1 e^{-(\lambda + \mu)t} + r(1 - e^{-(\lambda + \mu)t}). \end{aligned}$$

This example illustrated an ordinary lumping of a standard Markov chain.

- b. Let (σ, Π, Q, ρ) be the discontinuous Markov reward chain from Example 10b and let $r_1 = r_2 \stackrel{\text{def}}{=} r$. Recall that

$$\Pi = \begin{pmatrix} 1-p & p & 0 \\ 1-p & p & 0 \\ 0 & 0 & 1 \end{pmatrix}, \quad Q = \begin{pmatrix} -p(1-p)\lambda & -p^2\lambda & p\lambda \\ -p(1-p)\lambda & -p^2\lambda & p\lambda \\ 0 & 0 & 0 \end{pmatrix} \quad \text{and} \quad \rho = \begin{pmatrix} r_1 \\ r \\ r \end{pmatrix}.$$

We also let $\sigma = (\pi \ 1-\pi \ 0)$. We show that $\mathcal{P} = \{\{1, 2\}, \{3\}\}$ is an ordinary lumping. This easily follows after looking at the corresponding rows of ρ and of the following matrices:

$$\Pi V = \begin{pmatrix} 1 & 0 \\ 1 & 0 \\ 0 & 1 \end{pmatrix}, \quad Q = \begin{pmatrix} -p\lambda & p\lambda \\ -p\lambda & p\lambda \\ 0 & 0 & 0 \end{pmatrix}.$$

The lumped process $(\hat{\sigma}, \hat{\Pi}, \hat{Q}, \hat{\rho})$ is defined by:

$$\hat{\sigma} = (1 \ 0), \quad \hat{\Pi} = \begin{pmatrix} 1 & 0 \\ 0 & 1 \end{pmatrix}, \quad \hat{Q} = \begin{pmatrix} -p\lambda & p\lambda \\ 0 & 0 \end{pmatrix} \quad \text{and} \quad \hat{\rho} = \begin{pmatrix} r \\ r_3 \end{pmatrix}.$$

Note that, in this case, the lumped process is a Markov reward chain.

By setting $r_1 = r_2 = r$ in the total reward from Example 10b we have $R(t) = ((1-p)r_1 + pr_2 - r_3)e^{-p\lambda t} + r_3 = (r - r_3)e^{-p\lambda t} + r_3$. We calculate

$$\begin{aligned} \hat{R}(t) &= \hat{\sigma} \hat{P}(t) \hat{\rho} = \hat{\sigma} e^{\hat{Q}t} \hat{\rho} = (1 \ 0) \begin{pmatrix} e^{-p\lambda t} & 1-e^{-p\lambda t} \\ 0 & 1 \end{pmatrix} \begin{pmatrix} r \\ r_3 \end{pmatrix} = \\ &= (r - r_3)e^{-p\lambda t} + r_3 = R(t). \end{aligned}$$

In this example a whole ergodic class constitutes a lumping class. It is not hard to show that an ergodic class is always a correct lumping class when the states inside all have the same reward. By lumping the whole ergodic class we obtain a regular state in the lumped process. This allows to see the time that the original process spends switching among the states in this ergodic class (the time is always exponential and in this case with rate $p\lambda$).

Note that we always obtain a reward vector with equal elements for states belonging to the same ergodic class after multiplying the original reward vector by Π (cf. Example 10b). Recall that nothing is lost by this operation if only the total reward is to be calculated.

- c. Let (σ, Π, Q, ρ) be the discontinuous Markov reward chain from Example 10c. If $\lambda \neq \mu$, then this discontinuous Markov chain does not have a non-trivial lumping. States 2 and 3 cannot belong to the same class because they have different rates leading to state 4. The state 1 cannot be joined together with state 2 because 2 cannot reach state 3 whereas state 1 can. Similarly, state 1 cannot be joined together with state 3.

However, if $\lambda = \mu$ and $r_2 = r_3 \stackrel{\text{def}}{=} r$, then the partitioning $\mathcal{P} = \{\{1\}, \{2, 3\}, \{4\}\}$ is an ordinary lumping and (σ, Π, Q, ρ) lumps (with

respect to \mathcal{P} to $(\hat{\sigma}, \hat{\Pi}, \hat{Q}, \hat{\rho})$ defined by:

$$\hat{\sigma} = (1 \ 0 \ 0), \quad \hat{\Pi} = \begin{pmatrix} 0 & 1 & 0 \\ 0 & 1 & 0 \\ 0 & 0 & 1 \end{pmatrix}, \quad \hat{Q} = \begin{pmatrix} 0 & -\lambda & \lambda \\ 0 & -\lambda & \lambda \\ \nu & 0 & -\nu \end{pmatrix} \quad \text{and} \quad \hat{\rho} = \begin{pmatrix} r_1 \\ r \\ r_4 \end{pmatrix}.$$

This is an example when the lumped process is not a Markov reward chain. With the same requirements as before, also the partitioning $\mathcal{P} = \{\{1, 2, 3\}, \{4\}\}$ is an ordinary lumping. With respect to this partitioning (σ, Π, Q, ρ) lumps to $(\hat{\sigma}, \hat{\Pi}, \hat{Q}, \hat{\rho})$ defined as:

$$\hat{\sigma} = (1 \ 0), \quad \hat{\Pi} = \begin{pmatrix} 1 & 0 \\ 0 & 1 \end{pmatrix}, \quad \hat{Q} = \begin{pmatrix} -\lambda & \lambda \\ \nu & -\nu \end{pmatrix}, \quad \text{and} \quad \hat{\rho} = \begin{pmatrix} r \\ r_4 \end{pmatrix}$$

which is a standard Markov reward chain.

This example shows how transient states are lumped together with ergodic states. It is not hard to show that if a transient state can be trapped only in one ergodic class, then it can always be lumped with states from that ergodic class. Note that, when the reward vector is multiplied by Π , the original reward on the transient state becomes irrelevant because it becomes the same as the new reward for the ergodic states. Also, if a transient state can be trapped in more than one ergodic class, and if the lumping class that contains this transient state also contains some states from one of these ergodic classes, then this lumping class must contain states from all of these ergodic classes.

3.2 τ -lumping

In this section we introduce a notion of lumping for Markov reward chains with fast transitions. This notion is based on the ordinary lumping for discontinuous Markov reward chains: a partitioning is a lumping of a Markov reward chain with fast transitions if it is an ordinary lumping of its limit.

Definition 26 (τ -lumping). *A partitioning \mathcal{P} of a Markov reward chain with fast transitions (σ, Q_s, Q_f, ρ) is called a τ -lumping if it is an ordinary lumping of the discontinuous Markov chain (σ, Π, Q, ρ) , where $(\sigma, Q_s, Q_f, \rho) \rightarrow_{\infty} (\sigma, \Pi, Q, \rho)$.*

We give a definition of the lumped process by multiplying σ , Q_s , Q_f and ρ with the collector matrix and a distributor matrix, similarly as we did for discontinuous Markov chains. This technique ensures that the lumped versions of Q_s and Q_f are also generator matrices and that, consequently, we obtain a Markov reward chain with fast transitions as a result. However, since the lumping condition does not hold for Q_s and Q_f (i.e. we *do not* have that $VUQ_sV = Q_sV$ and $VUQ_fV = Q_fV$, but only that $VU\Pi V = \Pi V$ and $VUQV = QV$), we cannot guarantee that the definition of the lumped process does not depend on

the choice for a distributor. We define a class of special distributors, called τ -distributors, that give a lumped process of which the limit is the lumped version of the limit of the original Markov reward chain with fast transitions.

Before we present the definition of τ -distributors, we state a lemma that provides a connection between the lumping and the ergodic classes. We will use this result to achieve a renumbering that simplifies the presentation of the distributors. Intuitively, if two lumping classes contain states from a same ergodic class, then whenever one of the lumping classes contains states from another ergodic class, the other must also contain states from that ergodic class.

Lemma 27. *Let (σ, Q_s, Q_f, ρ) be a Markov reward chain with fast transitions. Let $\mathcal{E} = \{E_1, \dots, E_M, T\}$ be its ergodic partitioning and let $\mathcal{P} = \{C_1, \dots, C_N\}$ be a τ -lumping. Then, for all $1 \leq I, J \leq M$ and all $1 \leq K, L \leq N$, if $E_I \cap C_K \neq \emptyset$, $E_J \cap C_K \neq \emptyset$ and $E_I \cap C_L \neq \emptyset$, then $E_J \cap C_L \neq \emptyset$.*

Proof. See [22].

With Lemma 27 we can introduce a convenient arrangement of the ergodic and lumping classes.

Corollary 28. *Let $\mathcal{E} = \{E_1, \dots, E_M, T\}$ and $\mathcal{P} = \{C_1, \dots, C_N\}$ be the ergodic partitioning and a τ -lumping respectively of some Markov reward chain with fast transitions. Let $1 \leq L \leq N$ be the number of lumping classes that contain ergodic states and let the lumping classes be rearranged as $C_1, \dots, C_L, C_{L+1}, \dots, C_N$ such that C_1, \dots, C_L contain states from ergodic classes (and possibly some transient states too), while $C_{(L+1)1}, \dots, C_{N1}$ consist exclusively of transient states. Then, C_1, \dots, C_L and E_1, \dots, E_M can be further arranged and divided into S blocks E_{i1}, \dots, E_{ie_i} and C_{i1}, \dots, C_{ic_i} where, for all $1 \leq j \leq e_i$, $1 \leq k \leq c_i$, $E_{ij} \cap C_{ik} \neq \emptyset$, and that E_{ij} has no common elements with other lumping classes, for some S and c_i, e_i , $1 \leq i \leq S$ and $L = \sum_{i=1}^S c_i$.*

We give an example of such arrangement.

Example 29. Presuppose a Markov reward chain with fast transitions. Let $\mathcal{E} = \{E_1, E_2, E_3, T\}$ where $E_1 = \{2, 5\}$, $E_2 = \{6, 8\}$, $E_3 = \{4, 7\}$ and $T = \{1, 3\}$ be its ergodic partitioning. Let $\mathcal{P} = \{C_1, C_2, C_3, C_4\}$ where $C_1 = \{1\}$, $C_2 = \{2, 4\}$, $C_3 = \{5, 7\}$ and $C_4 = \{3, 6, 8\}$ be a τ -lumping. Note that the ergodic classes E_1 and E_3 share states from the lumping classes C_2 and C_3 and that E_2 shares states only with C_4 . So, $L = 3$ and $S = 2$. We now renumber ergodic and lumping classes as $E_1 \mapsto E_{11}$, $E_3 \mapsto E_{12}$, $C_2 \mapsto C_{11}$, $C_3 \mapsto C_{12}$, $E_2 \mapsto E_{21}$, $C_4 \mapsto C_{21}$ and $C_1 \mapsto C_3$.

Now, we can give the definition of a τ -distributor and of the τ -lumped chain.

Definition 30 (The τ -lumped process). *Let (σ, Q_s, Q_f, ρ) be a Markov reward chain with fast transitions. Let $\mathcal{P} = \{C_{11}, \dots, C_{S e_S}, C_{L+1}, \dots, C_N\}$ and*

$\mathcal{E} = \{E_{11}, \dots, E_{S e_S}, T\}$ be its τ -lumping and its ergodic partitioning respectively, conforming to Corollary 28. Let $\Pi = \lim_{t \rightarrow \infty} e^{Q_f t}$. Define $W \in \mathbb{R}^{N \times n}$ as

$$W[K, i] = \begin{cases} 0, & i \notin C_K \\ \alpha_{j\ell} e_j \frac{\Pi[i, i]}{\sum_{k \in C_k} \Pi[k, k]}, & i \in C_K, 1 \leq K \leq L, C_K = C_{j\ell}, i \in E_{j\ell} \\ 0 & i \in C_K, 1 \leq K \leq L, C_K = C_{j\ell}, i \in T \\ \beta_{Ki}, & i \in C_K, L+1 \leq K \leq N \end{cases},$$

where $\alpha_{j\ell} > 0$ for $1 \leq j \leq S$ and $1 \leq \ell \leq e_j$ are arbitrary, subject only to $\sum_{p=1}^{e_j} \alpha_{jp} = 1$, and where $\beta_{Ki} > 0$ are also arbitrary and subject to $\sum_{i \in C_K} \beta_{Ki} = 1$. Any matrix W of this form is called a τ -distributor.

Define $\hat{\sigma} \in \mathbb{R}^{1 \times N}$, $\hat{Q}_s \in \mathbb{R}^{N \times N}$, $\hat{Q}_f \in \mathbb{R}^{N \times N}$ and $\hat{\rho} \in \mathbb{R}^{N \times 1}$ as

$$\hat{\sigma} = \sigma V, \hat{Q}_s = W Q_s V, \hat{Q}_f = W Q_f V \text{ and } \hat{\rho} = W \rho,$$

for some τ -distributor W . We say that (σ, Q_s, Q_f, ρ) τ -lumps to $(\hat{\sigma}, \hat{Q}_s, \hat{Q}_f, \hat{\rho})$ with respect to \mathcal{P} and write this as $(\sigma, Q_s, Q_f, \rho) \xrightarrow{\mathcal{P}}_{\tau} (\hat{\sigma}, \hat{Q}_s, \hat{Q}_f, \hat{\rho})$.

Note that $W \geq 0$. If we take $\alpha_{j\ell} = \frac{1}{e_j}$ for all $1 \leq \ell \leq e_j$, then it is directly seen that W is indeed a distributor matrix for \mathcal{P} . The proof of the same but in the general case will be given later.

Let us explain the form of a τ -distributor. Since it is a distributor, we can think of it as of a matrix that assigns weights to the rows of $Q_s V$ and $Q_f V$, and then sums them. When i is an ergodic state from the class E_{jm} then all lumping classes $C_{j\ell}$, for $1 \leq \ell \leq c_j$, have at least one state from that class. Moreover, they also contain at least one state from all classes $E_{j\ell}$, where $1 \leq \ell \leq e_j$. Note that the lumping condition still holds when Π is restricted to these states, and that the all states from one ergodic class have the same ergodic probabilities. The weights $\alpha_{j\ell} > 0$, for $1 \leq \ell \leq c_j$ that sum up to one can be arbitrarily distributed amongst ergodic classes shared by the same lumping classes. The weights are multiplied by the number e_j because the normalization constant $\sum_{k \in C_k} \Pi[k, k]$ is a sum calculated for all states of the e_j shared ergodic classes. As the transient states have no ergodic probabilities ($\Pi[i, i] = 0$ when $i \in T$) they are assigned weight 0 when lumped together with ergodic states. We also have complete freedom when lumping transient states only and we choose to assign them arbitrary weights (like in a standard fdistributor).

We note that it is also possible to specify the distributor without the renumbering. However, it is very hard to perform the matrix manipulation without the renumbering induced by Lemma 27. The alternative definition is stated as follows:

Definition 31 (Alternative specification of τ -distributor). Let (σ, Q_s, Q_f, ρ) be a Markov reward chain with fast transitions. Let $\mathcal{P} = \{C_1, \dots, C_N\}$ be its τ -lumping and $\mathcal{E} = \{E_1, \dots, E_M, T\}$ its ergodic partitioning. Let Π be the ergodic projection of Q_f . Put $e(K) = \{E_L \in \mathcal{E} \mid C_K \cap E_L \neq \emptyset\}$.

$\emptyset\}$. Then, a τ -distributor $W \in \mathbb{R}^{N \times n}$ is defined as

$$W[K, i] = \begin{cases} 0, & i \notin C_K \\ \alpha_{KL} e_K \frac{\Pi[i, i]}{\sum_{k \in C_K} \Pi[k, k]}, & i \in C_K \cap E_L \\ 0, & i \in C_K \cap T, e(K) \neq \emptyset \\ \beta_{Ki}, & i \in C_K, e(K) = \emptyset \end{cases},$$

where $\alpha_{KL} > 0$ if $E_L \in e(K)$, are arbitrary, subject only to $\sum_{L: E_L \in e(K)} \alpha_{KL} = 1$ and $\alpha_{KL} = \alpha_{K'L}$, and where $\beta_{Ki} > 0$ are also arbitrary and subject to $\sum_{i \in C_K} \beta_{Ki} = 1$, and where $e_k = |e(K)|$ for $1 \leq K, K' \leq N$, $1 \leq L \leq M$ and $i \in C_K$.

Note that because there are several choices for the parameters in the definition of τ -distributors, there are, in general, several Markov reward chains with fast transitions that the original Markov reward chain with fast transitions τ -lumps to. We will show later that all these processes are equivalent in the limit and moreover, that in some special cases, they are exactly equivalent.

We now give some examples; first some in which the τ -lumped process is unique.

Example 32. In this example we show that the Markov reward chains with fast transitions from Figure 4 τ -lump to those in Figure 6. Recall that the limits of these Markov reward chains with fast transitions are calculated in Example 14.

- a. Consider the Markov reward chain with fast transitions depicted in Figure 4a. Its ergodic partitioning is $\mathcal{E} = \{E_1, E_2, T\}$ with $E_1 = \{2\}$, $E_2 = \{3\}$ and $T = \{1\}$. We show that $\mathcal{P} = \{C_1, C_2\}$, with $C_1 = \{1, 2\}$ and $C_2 = \{3\}$, is a τ -lumping and that the process τ -lumps to the one in Figure 6a. To show that the lumping conditions hold we first obtain

$$\Pi = \begin{pmatrix} 0 & 1 & 0 \\ 0 & 1 & 0 \\ 0 & 0 & 1 \end{pmatrix} \quad \text{and} \quad V = \begin{pmatrix} 1 & 0 \\ 1 & 0 \\ 0 & 1 \end{pmatrix}.$$

Then

$$\Pi V = \begin{pmatrix} 1 & 0 \\ 1 & 0 \\ 0 & 1 \end{pmatrix}, \quad \Pi Q_s \Pi V = \begin{pmatrix} -\mu & \mu \\ -\mu & \mu \\ 0 & 0 \end{pmatrix} \quad \text{and} \quad \Pi \rho = \begin{pmatrix} r_2 \\ r_2 \\ r_3 \end{pmatrix}.$$

It is clear that the conditions for τ -lumping hold (rows corresponding to states in a same lumping class are equal).

We now construct a τ -distributor. Note that the lumping classes are already numbered as required because there are no classes that contain only transient states. In the arrangement of Corollary 28 we have that $S = L = 2$, $c_1 = c_2 = 1$, $e_1 = e_2 = 1$, and that $C_{11} = C_1 = \{1, 2\}$, $C_{21} = C_2 = \{3\}$, $E_{11} = E_1 = \{2\}$ and $E_{21} = E_2 = \{3\}$. From this, $\alpha_{11} = 1$, $\alpha_{21} = 1$, and there are no other parameters. We now obtain

$$W = \begin{pmatrix} 0 & 1 & 0 \\ 0 & 0 & 1 \end{pmatrix}.$$

Note that this is the only τ -distributor.

The τ -lumped process is now defined by the following; it is depicted in Figure 6a:

$$\hat{\sigma} = \sigma V = (1 \ 0), \quad \hat{Q}_s = W Q_s V = \begin{pmatrix} -\mu & \mu \\ 0 & 0 \end{pmatrix},$$

$$\hat{Q}_f = W Q_f V = \begin{pmatrix} 0 & 0 \\ 0 & 0 \end{pmatrix}, \quad \text{and } \hat{\rho} = W \rho = \begin{pmatrix} r_2 \\ r_3 \end{pmatrix}.$$

This example illustrates how, in transient states, fast transitions have priority over slow transitions. The transition labeled with λ is irrelevant. Because there is only one τ -distributor, it does not depend on the parameters, and so we have a unique τ -lumped process.

- b. Consider the Markov reward chain with fast transitions depicted in Figure 4b. It can be easily checked that $\mathcal{P} = \{C_1, C_2\}$, with $C_1 = \{1, 2\}$ and $C_2 = \{3\}$, is a τ -lumping. The lumping classes are numbered as needed, and we have $S = L = 2$, $c_1 = c_2 = 1$, $e_1 = e_2 = 1$, and $C_{11} = \{1, 2\}$, $C_{21} = \{3\}$, $E_{11} = \{1, 2\}$ and $E_{21} = \{3\}$. From this, $\alpha_{11} = 1$ and $\alpha_{21} = 1$. Recall from Example 14b that that

$$\Pi = \begin{pmatrix} \frac{b}{a+b} & \frac{a}{a+b} & 0 \\ \frac{b}{a+b} & \frac{a}{a+b} & 0 \\ 0 & 0 & 1 \end{pmatrix}.$$

We obtain

$$W = \begin{pmatrix} \frac{b}{a+b} & \frac{a}{a+b} & 0 \\ 0 & 0 & 1 \end{pmatrix}, \quad \hat{Q}_s = \begin{pmatrix} -\frac{a\lambda}{a+b} & \frac{a\lambda}{a+b} \\ 0 & 0 \end{pmatrix}, \quad \hat{Q}_f = \mathbf{0} \quad \text{and } \hat{\rho} = \begin{pmatrix} \frac{br_1+ar_2}{a+b} \\ r_3 \end{pmatrix}.$$

So, the process τ -lumps to the one in Figure 6b. As in the previous case, we only have one τ -distributor, and so, only one τ -lumped process.

This example shows that when two ergodic states with different slow transition rates are lumped together, the resulting state is ergodic and it can perform the same slow transition but with an adapted rate. The example also shows that the Markov reward chain with fast transitions of Figure 4b spends an exponentially distributed amount of time with rate $\frac{a\lambda}{a+b}$ in the class $\{1, 2\}$. This is the time that it spends switching between state 1 and state 2.

- c. Example 25b shows that for the Markov reward chain with fast transitions depicted in Figure 4c, the partitionings $\mathcal{P} = \{C_1, C_2, C_3\}$, with $C_1 = \{1\}$, $C_2 = \{2, 3\}$ and $C_3 = \{4\}$, and $\mathcal{P} = \{C_1, C_2\}$, with $C_1 = \{1, 2, 3\}$, $C_2 = \{4\}$, are τ -lumpings when $r_2 = r_3 \stackrel{\text{def}}{=} r$. The ergodic partitioning of this Markov reward chain with fast transitions is $\mathcal{E} = \{E_1, E_2, E_3, T\}$ where $E_1 = \{2\}$, $E_2 = \{3\}$, $E_3 = \{4\}$ and $T = \{1\}$

For the first partitioning we renumber classes to have those with ergodic states in front, and obtain $C_1 = \{2, 3\}$, $C_2 = \{4\}$ and $C_3 = \{1\}$. Now, we have $S = L = 2$, $c_1 = c_2 = 1$, $e_1 = 2$, $e_2 = 1$, and $C_{11} = \{2, 3\}$, $C_{21} = \{4\}$, $E_{11} = E_2 = \{2\}$, $E_{12} = E_3 = \{3\}$, and $E_{21} = \{4\}$. Since $e_2 = 1$, we have $\alpha_{21} = 1$. Since $e_1 = 2$, we have $\alpha_{11} \stackrel{\text{def}}{=} \alpha$ to be an arbitrary number between

0 and 1, and we have $\alpha_{12} = 1 - \alpha_{11} = 1 - \alpha$. This now gives the following τ -distributor (in the original numbering of classes) and the τ -lumped process.

$$W = \begin{pmatrix} 1 & 0 & 0 & 0 \\ 0 & \alpha & 1-\alpha & 0 \\ 0 & 0 & 0 & 1 \end{pmatrix}, \quad \hat{Q}_s = \begin{pmatrix} 0 & 0 & 0 \\ 0 & -\lambda & \lambda \\ \nu & 0 & -\nu \end{pmatrix},$$

$$\hat{Q}_f = \begin{pmatrix} -a-b & a+b & 0 \\ 0 & 0 & 0 \\ 0 & 0 & 0 \end{pmatrix} \quad \text{and} \quad \hat{\rho} = \begin{pmatrix} r_1 \\ r \\ r_4 \end{pmatrix}.$$

The τ -lumped process is depicted in Figure 6c. This example shows that τ -lumping need not eliminate all silent transitions. It also shows that even there might be more possible choices for the parameters in τ -distributors in some cases there is only one possible τ -lumped process.

For the second partitioning we similarly obtain

$$W = \begin{pmatrix} 0 & \alpha & 1-\alpha & 0 \\ 0 & 0 & 0 & 1 \end{pmatrix}, \quad \hat{Q}_s = \begin{pmatrix} -\lambda & \lambda \\ \nu & -\nu \end{pmatrix}, \quad \hat{Q}_f = \mathbf{0}, \quad \text{and} \quad \hat{\rho} = \begin{pmatrix} r \\ r_4 \end{pmatrix}.$$

The lumped Markov reward chain with fast transitions is depicted in Figure 6d. This example shows how transient states can be lumped with ergodic states, resulting in an ergodic state.

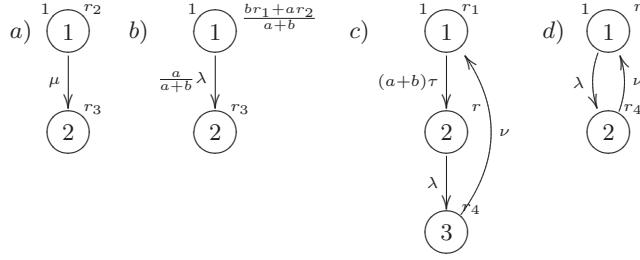

Fig. 6. τ -lumped Markov reward chains with fast transitions – Example 32

In the previous example all the lumping classes always contained some ergodic states, and moreover, there were not constructed from parts of different ergodic classes. This is why all the τ -lumped Markov reward chains with fast transitions did not depend on the particular choice for the parameters in the τ -distributor. The next example shows that this is not always the case.

Example 33. a. Consider the left Markov reward chain with fast transitions depicted in Figure 7a. It is defined by

$$\sigma = (1 \ 0 \ 0 \ 0), \quad Q_s = \begin{pmatrix} 0 & 0 & 0 & 0 \\ -\lambda & 0 & 0 & \lambda \\ 0 & 0 & 0 & 0 \\ 0 & 0 & 0 & 0 \end{pmatrix},$$

$$Q_f = \begin{pmatrix} 0 & 0 & 0 & 0 \\ 0 & -b & b & 0 \\ 0 & 0 & 0 & 0 \\ 0 & 0 & 0 & 0 \end{pmatrix} \quad \text{and} \quad \rho = \begin{pmatrix} r_1 \\ r_2 \\ r_3 \\ r_4 \end{pmatrix}.$$

It is not hard to show that $\mathcal{P} = \{\{1,2\}, \{3\}, \{4\}\}$ is a τ -lumping of this Markov reward chain with fast transitions. We only show that it τ -lumps to the Markov reward chain with fast transitions depicted in Figure 7a on the right. We obtain

$$H = \begin{pmatrix} 0 & 0 & 1 & 0 \\ 0 & 0 & 1 & 0 \\ 0 & 0 & 1 & 0 \\ 0 & 0 & 0 & 1 \end{pmatrix} \quad \text{and} \quad V = \begin{pmatrix} 1 & 0 & 0 \\ 1 & 0 & 0 \\ 0 & 1 & 0 \\ 0 & 0 & 1 \end{pmatrix}.$$

States 1 and 2 are both transient and constitute a lumping class. Because of this we have

$$W = \begin{pmatrix} \beta & 1-\beta & 0 & 0 \\ 0 & 0 & 1 & 0 \\ 0 & 0 & 0 & 1 \end{pmatrix} \quad \text{for some } 0 < \beta < 1,$$

and so

$$\hat{\sigma} = \sigma V = (1 \ 0 \ 0), \quad \hat{Q}_s = W Q_s V = \begin{pmatrix} -(1-\beta)\lambda & 0 & (1-\beta)\lambda \\ 0 & 0 & 0 \\ 0 & 0 & 0 \end{pmatrix},$$

$$\hat{Q}_f = W Q_f V = \begin{pmatrix} -(1-\beta)b & (1-\beta)b & 0 \\ 0 & 0 & 0 \\ 0 & 0 & 0 \end{pmatrix}, \quad \hat{\rho} = \begin{pmatrix} \beta r_1 + (1-\beta)r_2 \\ r_3 \\ r_4 \end{pmatrix}.$$

This Markov reward chain with fast transitions is indeed the right one in Figure 7a. The reasons why it depends on the parameters in W is because there is a lumping class, in this case the first one, that contains transient states only.

- b. Consider now the Markov reward chain with fast transitions depicted in Figure 7b on the left. It is defined by

$$\sigma = (1 \ 0 \ 0 \ 0 \ 0), \quad Q_s = \mathbf{0},$$

$$Q_f = \begin{pmatrix} -(a+b) & a & b & 0 & 0 \\ 0 & -c & 0 & c & 0 \\ 0 & 0 & -2c & 0 & 2c \\ 0 & d & 0 & -d & 0 \\ 0 & 0 & 2d & 0 & -2d \end{pmatrix} \quad \text{and} \quad \rho = \begin{pmatrix} r_1 \\ r_2 \\ r_3 \\ r_4 \\ r_5 \end{pmatrix}.$$

It is not hard to show that $\mathcal{P} = \{\{1\}, \{2,3\}, \{4,5\}\}$ is a τ -lumping of this Markov reward chain with fast transitions. We only show that it τ -lumps to

the Markov reward chain with fast transitions depicted in Figure 7b on the right. We obtain

$$II = \begin{pmatrix} 0 & \frac{ad}{(a+b)(c+d)} & \frac{bd}{(a+b)(c+d)} & \frac{ac}{(a+b)(c+d)} & \frac{bc}{(a+b)(c+d)} \\ 0 & \frac{d}{c+d} & 0 & \frac{c}{c+d} & 0 \\ 0 & 0 & \frac{d}{c+d} & 0 & \frac{c}{c+d} \\ 0 & \frac{d}{c+d} & 0 & \frac{c}{c+d} & 0 \\ 0 & 0 & \frac{d}{c+d} & 0 & \frac{c}{c+d} \end{pmatrix}.$$

From II and \mathcal{P} we have

$$W = \begin{pmatrix} 1 & 0 & 0 & 0 \\ 0 & \alpha & 1-\alpha & 0 & 0 & 0 \\ 0 & 0 & 0 & \alpha & 1-\alpha & 0 \\ 0 & 0 & 0 & 0 & 0 & 1 \end{pmatrix} \text{ for some } 0 < \alpha < 1.$$

Note that the same parameter α appears, both in the row corresponding to class $\{2, 3\}$ and in the row corresponding to $\{4, 5\}$. This is because these two classes belong to the same group, i.e. they share states from the same ergodic classes.

Now,

$$\hat{\sigma} = (1 \ 0 \ 0), \quad \hat{Q}_s = \mathbf{0},$$

$$\hat{Q}_f = \begin{pmatrix} -(a+b) & a+b & 0 \\ 0 & -(2-\alpha)c & (2-\alpha)c \\ 0 & (2-\alpha)d & -(2-\alpha)d \end{pmatrix} \text{ and } \hat{\rho} = \begin{pmatrix} r_1 \\ \alpha r_2 + (1-\alpha)r_3 \\ \alpha r_4 + (1-\alpha)r_5 \end{pmatrix}.$$

This Markov reward chain with fast transitions is indeed the right one in Figure 7b. The reason why it depends on the parameters in W is because the second and the third lumping class contain states from different ergodic classes but do not contain complete ergodic classes.

The following example shows some Markov reward chains with fast transitions that are minimal in the sense that they only admit the trivial τ -lumpings.

Example 34. We show that, for $\lambda \neq \mu$, the Markov reward chains with fast transitions from Figure 8 admit only the trivial lumpings regardless of the reward structure. For this reason the rewards are omitted from the picture.

- Consider the Markov reward chain with fast transitions in Figure 8a. The reason why this Markov reward chain with fast transitions does not have a non-trivial lumping were already discussed in Example 25c.
- The Markov reward chain with fast transitions in Figure 8b also has only the trivial lumpings. We show that states 1 and 2 cannot be in the same lumping class. Let $\mathcal{P} = \{\{1, 2\}, \{3\}, \{4\}\}$. We easily obtain

$$II = \begin{pmatrix} 0 & 0 & \frac{a+c+b(c+d)}{(a+b)(c+d)} & \frac{ad}{(a+b)(c+d)} \\ 0 & 0 & \frac{c}{c+d} & \frac{d}{c+d} \\ 0 & 0 & 1 & 0 \\ 0 & 0 & 0 & 1 \end{pmatrix} \text{ and } V = \begin{pmatrix} 1 & 0 & 0 \\ 1 & 0 & 0 \\ 0 & 1 & 0 \\ 0 & 0 & 1 \end{pmatrix}.$$

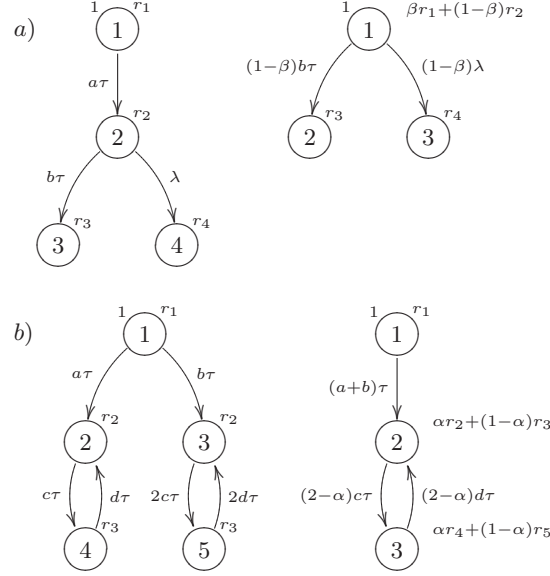

Fig. 7. τ -lumping where the τ -lumped process depends on the parameters in the τ -distributor – Example 33

Then

$$HIV = \begin{pmatrix} 0 & \frac{a}{a+b} \frac{c+d}{c+d} & \frac{a}{a+b} \frac{d}{c+d} \\ 0 & \frac{c}{c+d} & \frac{d}{c+d} \\ 0 & 1 & 0 \\ 0 & 0 & 1 \end{pmatrix}.$$

In order for the lumping condition to hold for \mathcal{P} we must have $\frac{a}{a+b} \frac{d}{c+d} = \frac{d}{c+d}$ which is impossible because $\frac{a}{a+b} < 1$.

- c. Consider the Markov reward chain with fast transitions in Figure 8c. This Markov reward chain with fast transitions only has a nontrivial lumping when $b = c$. We show that states 1 and 2 can be in the same lumping class only in this case. Let $\mathcal{P} = \{\{1, 2\}, \{3\}, \{4\}\}$. We easily obtain

$$H = \begin{pmatrix} 0 & 0 & \frac{a}{a+b} & \frac{b}{a+b} & 0 \\ 0 & 0 & \frac{a}{a+c} & \frac{c}{a+c} & 0 \\ 0 & 0 & 1 & 0 & 0 \\ 0 & 0 & 0 & 1 & 0 \\ 0 & 0 & 0 & 0 & 1 \end{pmatrix} \quad \text{and} \quad V = \begin{pmatrix} 1 & 0 & 0 \\ 1 & 0 & 0 \\ 0 & 1 & 0 \\ 0 & 0 & 1 \end{pmatrix}.$$

As in the previous example for the lumping condition to hold we must have that $\frac{a}{a+b} = \frac{a}{a+c}$. This is only possible when $b = c$.

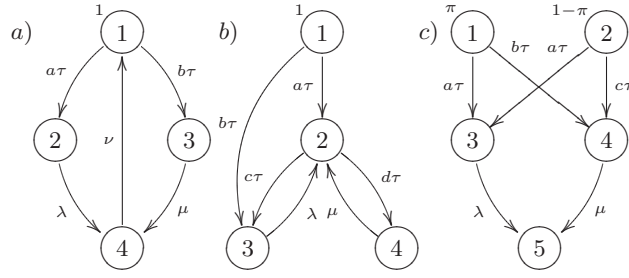
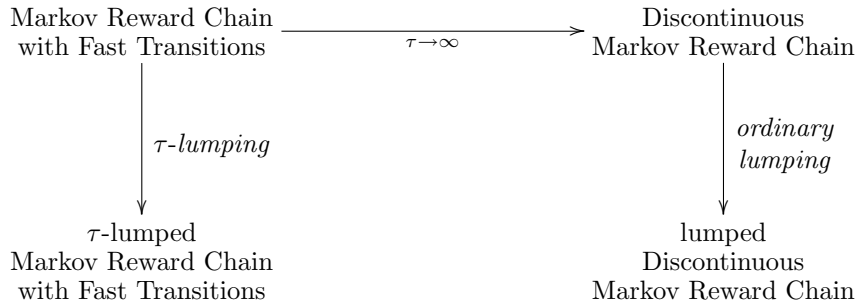
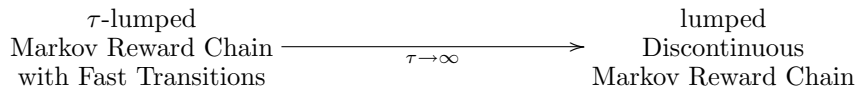

Fig. 8. Markov reward chains with fast transitions without non-trivial τ -lumpings – Example 34

Definition 30 of τ -lumping and Definition induces the following diagram:



We now show that the diagram can be closed, i.e. that



The notion of τ -lumping is based only on the limit process, and so, this property is important since it somehow proves the definition of the τ -lumped process correct.

To establish this correctness we first show the main feature of a τ -distributor W , which is that $II V W II = II V W$, holds. Intuitively, the equality states that W distributes the lumped ergodic states of a lumping class according to their re-normalized ergodic probabilities. For a smooth proof of this property we introduce a convenient numbering of states. This numbering also allows us to prove that W is a distributor for any choice of the parameters. Assuming that ergodic and lumping classes are arranged according to Corollary 28, we renumber the states in such a way that those that belong to an ergodic class with a lower index precede those that belong to an ergodic class with a higher index (assuming the lexicographic order). Additionally, we divide transient states into those that are lumped together with some ergodic states and those that are lumped only with other transient states, and then renumber them so that those that belong to the

first group precede those from the second group. We give an example of this renumbering.

Example 35. Consider the Markov reward chain with fast transitions depicted in Figure 9a (we omit the reward structure, but assume that the reward vector is permuted accordingly). It directly follows that the partitionings \mathcal{E} and \mathcal{P} from Example 29 are the ergodic partitioning and a τ -lumping for this Markov reward chain with fast transitions. From the same example, after the rearrangement we have $\mathcal{E} = \{E_{11}, E_{12}, E_{21}, T\}$ and $\mathcal{P} = \{C_{11}, C_{12}, C_{21}, C_3\}$ with $E_{11} = \{2, 5\}$, $E_{12} = \{4, 7\}$, $E_{21} = \{6, 8\}$, $T = \{1, 3\}$ and $C_{11} = \{2, 4\}$, $C_{12} = \{5, 7\}$, $C_{21} = \{3, 6, 8\}$, $C_3 = \{1\}$. Note that the transient state 3 lumps together with the ergodic states 6 and 8, and that the transient state 1 lumps alone. Now, we renumber states as $2 \mapsto 1$, $5 \mapsto 2$, $4 \mapsto 3$, $7 \mapsto 4$, $6 \mapsto 5$, $8 \mapsto 6$, $3 \mapsto 7$, and $1 \mapsto 8$. The new Markov reward chain with fast transitions is depicted in 9b.

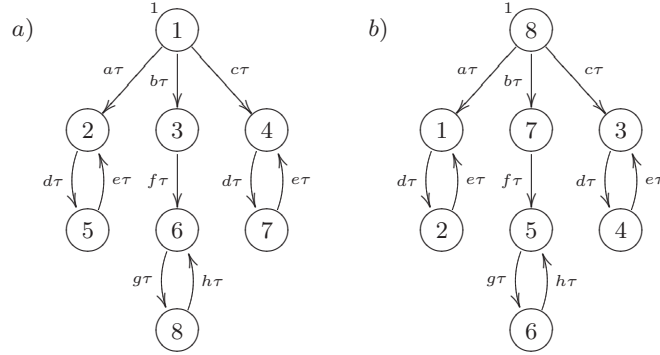

Fig. 9. Markov reward chain with fast transitions before and after the renumbering of states – Example 35

We now present the matrices Π , V and W in the new numbering. First we have

$$\Pi = \begin{pmatrix} \Pi_1 & \mathbf{0} & \dots & \mathbf{0} & \mathbf{0} & \mathbf{0} \\ \mathbf{0} & \Pi_2 & \dots & \mathbf{0} & \mathbf{0} & \mathbf{0} \\ \vdots & \vdots & \ddots & \vdots & \vdots & \vdots \\ \mathbf{0} & \mathbf{0} & \dots & \Pi_S & \mathbf{0} & \mathbf{0} \\ \overline{\Pi}_1 & \overline{\Pi}_2 & \dots & \overline{\Pi}_S & \mathbf{0} & \mathbf{0} \\ \tilde{\Pi}_1 & \tilde{\Pi}_2 & \dots & \tilde{\Pi}_S & \mathbf{0} & \mathbf{0} \end{pmatrix} \quad \begin{aligned} \Pi_i &= \text{diag}(\Pi_{i1}, \dots, \Pi_{ie_i}) & \Pi_{ij} &= \mathbf{1}^{|E_{ij}|} \cdot \mu_{ij} \\ \overline{\Pi}_i &= (\overline{\Pi}_{i1} \dots \overline{\Pi}_{ie_i}) & \overline{\Pi}_{ij} &= \bar{\delta}_{ij} \cdot \mu_{ij} \\ \tilde{\Pi}_i &= (\tilde{\Pi}_{i1} \dots \tilde{\Pi}_{ie_i}) & \tilde{\Pi}_{ij} &= \tilde{\delta}_{ij} \cdot \mu_{ij}, \end{aligned}$$

where the matrices $\overline{\Pi}_i$ and $\tilde{\Pi}_i$ respectively correspond to the transient states that are lumped together with ergodic classes and to the ones that are lumped only with other transient states. The vector μ_{ij} is the ergodic probability vector for

the ergodic class E_{ij} . The vectors $\bar{\delta}_{ij}$ and $\tilde{\delta}_{ij}$ are the corresponding restrictions of the vector δ_{ij} which is the vector of trapping probabilities for E_{ij} .

The collector matrix V associated with \mathcal{P} now has the following form:

$$V = \begin{pmatrix} V_1 & \mathbf{0} & \dots & \mathbf{0} & \mathbf{0} \\ \mathbf{0} & V_2 & \dots & \mathbf{0} & \mathbf{0} \\ \vdots & \vdots & \ddots & \vdots & \vdots \\ \mathbf{0} & \mathbf{0} & \dots & V_S & \mathbf{0} \\ \bar{V}_1 & \bar{V}_2 & \dots & \bar{V}_S & \mathbf{0} \\ \mathbf{0} & \mathbf{0} & \dots & \mathbf{0} & \tilde{V} \end{pmatrix} \quad V_i = \begin{pmatrix} V_{i1} \\ \vdots \\ V_{ie_i} \end{pmatrix}$$

$$\begin{aligned} V_{ij} &= \text{diag}(\mathbf{1}^{|E_{ij} \cap C_{i1}|}, \dots, \mathbf{1}^{|E_{ij} \cap C_{ie_i}|}) \\ \bar{V}_i &= \text{diag}(\mathbf{1}^{|T \cap C_{i1}|}, \dots, \mathbf{1}^{|T \cap C_{ie_i}|}) \\ \tilde{V} &= \text{diag}(\mathbf{1}^{|T \cap C_{L+1}|}, \dots, \mathbf{1}^{|T \cap C_N|}). \end{aligned}$$

Note that the matrices \bar{V}_i are non necessarily collector matrices. They are allowed to have zero columns.

Let $\mu_{ij}^{(k)}$ denote the restriction of μ_{ij} to the elements of C_{ik} . The vector $\mu_{ij}^{(k)}$ is never empty because $C_{ik} \cap E_{ij} \neq \emptyset$. Then we write

$$\Pi_i V_i = \begin{pmatrix} \Pi_{i1} V_{i1} \\ \vdots \\ \Pi_{ie_i} V_{ie_i} \end{pmatrix} = \begin{pmatrix} \mathbf{1}^{|E_{i1}|} \cdot \mu_{i1}^{(1)} \cdot \mathbf{1} & \dots & \mathbf{1}^{|E_{i1}|} \cdot \mu_{i1}^{(c_i)} \cdot \mathbf{1} \\ \vdots & & \vdots \\ \mathbf{1}^{|E_{ie_i}|} \cdot \mu_{ie_i}^{(1)} \cdot \mathbf{1} & \dots & \mathbf{1}^{|E_{ie_i}|} \cdot \mu_{ie_i}^{(c_i)} \cdot \mathbf{1} \end{pmatrix}.$$

From the lumping condition it follows that the rows of $\Pi_i V_i$ that correspond to the same lumping class are equal. This implies that

$$\mu_{ij}^{(\ell)} \cdot \mathbf{1} = \mu_{ik}^{(\ell)} \cdot \mathbf{1},$$

for all $1 \leq j, k \leq e_i$, $1 \leq \ell \leq c_i$. Define a row vector $\phi_i \in \mathbb{R}^{1 \times c_i}$ as

$$\phi_i[\ell] = \mu_{ij}^{(\ell)} \cdot \mathbf{1}$$

(for any $1 \leq j \leq e_i$). Then

$$\mu_{ij} V_{ij} = \phi_i, \text{ for any } 1 \leq j \leq e_i, \text{ and } \Pi_i V_i = \mathbf{1} \cdot \phi_i.$$

The matrix W of Definition 30 has the following form:

$$W = \begin{pmatrix} W_1 & \mathbf{0} & \dots & \mathbf{0} & \mathbf{0} & \mathbf{0} \\ \mathbf{0} & W_2 & \dots & \mathbf{0} & \mathbf{0} & \mathbf{0} \\ \vdots & \vdots & \ddots & \vdots & \vdots & \vdots \\ \mathbf{0} & \mathbf{0} & \dots & W_S & \mathbf{0} & \mathbf{0} \\ \mathbf{0} & \mathbf{0} & \dots & \mathbf{0} & \mathbf{0} & \tilde{W} \end{pmatrix} \quad \begin{aligned} W_i &= (W_{i1} \dots W_{ie_i}) \\ \tilde{W} &= \text{diag}(\tilde{w}_{L+1}, \dots, \tilde{w}_N) \end{aligned}$$

where

$$W_{ij} = \text{diag} \left(\frac{\alpha_{ij} e_i \mu_{ij}^{(1)}}{\sum_{k=1}^{e_i} \mu_{ik}^{(1)} \cdot \mathbf{1}}, \dots, \frac{\alpha_{ij} e_i \mu_{ij}^{(c_i)}}{\sum_{k=1}^{e_i} \mu_{ik}^{(c_i)} \cdot \mathbf{1}} \right).$$

and

$$\tilde{w}_i = (\beta_{i1} \dots \beta_{i|C_i|}), \quad 0 < \beta_{ij} < 1.$$

Using the definition of ϕ , we have:

$$\begin{aligned} W_{ij} &= \text{diag} \left(\frac{\alpha_{ij} e_i \mu_{ij}^{(1)}}{\sum_{k=1}^{e_i} \mu_{ik}^{(1)} \cdot \mathbf{1}}, \dots, \frac{\alpha_{ij} e_i \mu_{ij}^{(c_i)}}{\sum_{k=1}^{e_i} \mu_{ik}^{(c_i)} \cdot \mathbf{1}} \right) \\ &= \alpha_{ij} e_i \cdot \text{diag} \left(\frac{\mu_{ij}^{(1)}}{\sum_{k=1}^{e_i} \phi_i[1]}, \dots, \frac{\mu_{ij}^{(c_i)}}{\sum_{k=1}^{e_i} \phi_i[c_i]} \right) \\ &= \frac{\alpha_{ij} e_i}{e_i} \cdot \text{diag} \left(\frac{\mu_{ij}^{(1)}}{\phi_i[1]}, \dots, \frac{\mu_{ij}^{(c_i)}}{\phi_i[c_i]} \right) \\ &= \alpha_{ij} \cdot \text{diag} \left(\frac{\mu_{ij}^{(1)}}{\phi_i[1]}, \dots, \frac{\mu_{ij}^{(c_i)}}{\phi_i[c_i]} \right). \end{aligned}$$

Let us now prove that $W \geq 0$ is a distributor, i.e. that $WV = I$. We have

$$WV = \begin{pmatrix} W_1 V_1 & \mathbf{0} & \dots & \mathbf{0} & \mathbf{0} \\ \mathbf{0} & W_2 V_2 & \dots & \mathbf{0} & \mathbf{0} \\ \vdots & \vdots & \ddots & \vdots & \vdots \\ \mathbf{0} & \mathbf{0} & \dots & W_S V_S & \mathbf{0} \\ \mathbf{0} & \mathbf{0} & \dots & \mathbf{0} & \tilde{W}\tilde{V} \end{pmatrix}, \quad W_i V_i = \sum_{j=1}^{e_i} W_{ij} V_{ij}$$

and

$$\tilde{W}\tilde{V} = \text{diag} \left(\tilde{w}_{L+1} \cdot \mathbf{1}^{|T \cap C_{L+1}|}, \dots, \tilde{w}_N \cdot \mathbf{1}^{|T \cap C_N|} \right).$$

We first have

$$\begin{aligned} W_{ij} V_{ij} &= \alpha_{ij} \cdot \text{diag} \left(\frac{\mu_{ij}^{(1)}}{\phi_i[1]}, \dots, \frac{\mu_{ij}^{(c_i)}}{\phi_i[c_i]} \right) \cdot \text{diag} \left(\mathbf{1}^{|E_{ij} \cap C_{i1}|}, \dots, \mathbf{1}^{|E_{ij} \cap C_{ic_i}|} \right) = \\ &= \alpha_{ij} \cdot \text{diag} \left(\frac{\mu_{ij}^{(1)} \cdot \mathbf{1}}{\phi_i[1]}, \dots, \frac{\mu_{ij}^{(c_i)} \cdot \mathbf{1}}{\phi_i[c_i]} \right) = \alpha_{ij} \cdot \text{diag} \left(\frac{\phi_i[1]}{\phi_i[1]}, \dots, \frac{\phi_i[c_i]}{\phi_i[c_i]} \right) = \alpha_{ij} I. \end{aligned}$$

Now,

$$W_i V_i = \sum_{j=1}^{e_i} W_{ij} V_{ij} = \sum_{j=1}^{e_i} \alpha_{ij} I = I,$$

because $\sum_{j=1}^{e_i} \alpha_{ij} = 1$. Also, for all $L+1 \leq K \leq N$,

$$\tilde{w}_K \cdot \mathbf{1}^{|T \cap C_K|} = \sum_{k=1}^{|C_K|} \beta_{ik} = 1.$$

Lemma 36. *Let Π, V and W be as in Definition 30. Then*

$$\Pi V W \Pi = \Pi V W.$$

Proof. Using the block structure of Π , V and W , after a simple block-matrix calculation, it follows that $\Pi V W \Pi = \Pi V W$ iff, for all $1 \leq i \leq S$,

$$X_i V_i W_i \Pi_i = X_i V_i W_i \text{ for } X_i \in \{\Pi_i, \bar{\Pi}_i, \tilde{\Pi}_i\}.$$

Going one level deeper in the matrix structure, we obtain that $X_i V_i W_i \Pi_i = X_i V_i W_i$ iff

$$\mu_{ij} V_{ij} W_{ik} \Pi_{ik} = \mu_{ij} V_{ij} W_{ik}$$

for all $1 \leq j, k \leq e_i$. Furthermore, from the definition of ϕ_i it follows that

$$\begin{aligned} \mu_{ij} V_{ij} &= \left(\mu_{ij}^{(1)} \dots \mu_{ij}^{(c_i)} \right) \cdot \text{diag} \left(\mathbf{1}^{|E_{ij} \cap C_{i1}|}, \dots, \mathbf{1}^{|E_{ij} \cap C_{ic_i}|} \right) = \\ &= \left(\mu_{ij}^{(1)} \cdot \mathbf{1}^{|E_{ij} \cap C_{i1}|} \dots \mu_{ij}^{(c_i)} \cdot \mathbf{1}^{|E_{ij} \cap C_{ic_i}|} \right) = (\phi_i[1] \dots \phi_i[c_i]) = \phi. \end{aligned}$$

Therefore, the equality $\mu_{ij} V_{ij} W_{ik} \Pi_{ik} = \mu_{ij} V_{ij} W_{ik}$ holds iff

$$\phi_i W_{ik} \Pi_{ik} = \phi_i W_{ik}$$

holds. We first calculate

$$\phi_i W_{ik} = (\phi_i[1] \dots \phi_i[c_i]) \cdot \alpha_{ik} \cdot \text{diag} \left(\frac{\mu_{ik}^{(1)}}{\phi_i[1]}, \dots, \frac{\mu_{ik}^{(c_i)}}{\phi_i[c_i]} \right) = \alpha_{ik} \cdot \mu_{ik},$$

and then

$$\phi_i W_{ik} \Pi_{ik} = \alpha_{ik} \cdot \mu_{ik} \cdot \mathbf{1} \cdot \mu_{ik} = \alpha_{ik} \cdot \mathbf{1} \cdot \mu_{ik} = \phi_i W_{ik}.$$

It is not hard to show that the converse of this theorem also holds in some special case. Any distributor W that has only non-zero elements associated to transient states that are lumped only with other transient states, and that satisfies $\Pi V W \Pi = \Pi V W$, must be of the form from Definition 30, i.e. must be a τ -distributor.

The property $\Pi V W \Pi = \Pi V W$ is crucial in the proof that \hat{Q}_s and $\hat{\rho}$ are correctly defined. We now introduce some notions and prove a lemma that plays an important role in the proof that \hat{Q}_f is also correctly defined.

A matrix $G \in \mathbb{R}^{n \times n}$ such that $G \cdot \mathbf{1} \leq \mathbf{0}$ and $G + cI \geq \mathbf{0}$ for some $c > 0$ is called a *semi-generator* matrix. In other words, a semi-generator is a matrix in which a negative element can only be on the diagonal, and the absolute value of this element is bigger than or equal to the sum of the other elements in the row. A semi-generator is called *indecomposable* if it cannot be represented (after any renumbering) as $\begin{pmatrix} Q & \mathbf{0} \\ X & Y \end{pmatrix}$ where Q is a generator matrix.

Lemma 37. *Let $G \in \mathbb{R}^{n \times n}$ be an indecomposable semi-generator. Then*

a. G is invertible, i.e. of full rank; and

- b. $UGV \in \mathbb{R}^{N \times N}$ is an indecomposable semi-generator for any collector matrix $V \in \mathbb{R}^{n \times N}$, and any distributor $U \in \mathbb{R}^{N \times n}$ associated to V such that $V[i, K] = 1$ implies $U[K, i] > 0$, for all $1 \leq i \leq n$ and $1 \leq K \leq N$.

Proof. a. Suppose that G is not invertible. We construct a numbering in which $G = \begin{pmatrix} Q & \mathbf{0} \\ X & Y \end{pmatrix}$ and Q is a generator matrix. Let $r_1, \dots, r_n \in \mathbb{R}^{1 \times n}$ be the row vectors that correspond to the rows of G . Let the rows with elements that sum up to 0 precede those of which this sum is less than 0, i.e. let the numbering of states be such that, for some $1 \leq k \leq n$, we have $r_i \cdot \mathbf{1} = 0$, for $1 \leq i \leq k$, and $r_i \cdot \mathbf{1} < 0$, for $k+1 \leq i \leq n$. Since G is not invertible, there exists an $1 \leq \ell \leq n$ such that $\alpha_\ell r_\ell = \alpha_1 r_1 + \dots + \alpha_{\ell-1} r_{\ell-1} + \alpha_{\ell+1} r_{\ell+1} + \dots + \alpha_n r_n$ for some $\alpha_1, \dots, \alpha_n$ with $\alpha_\ell = 1$. Now, we can apply Theorem 2.1 of [29] and obtain that $r_\ell \cdot \mathbf{1} = 0$, i.e. that $\ell \leq k$, and that $\alpha_i = 0$ for all $k+1 \leq i \leq n$. From the same theorem we also obtain that $G[i, j] = 0$ for all $1 \leq i \leq k$ and $k+1 \leq j \leq n$. This directly means that $G = \begin{pmatrix} Q & \mathbf{0} \\ X & Y \end{pmatrix}$ where $Q = \begin{pmatrix} r_1 \\ \vdots \\ r_k \end{pmatrix}$ satisfies $Q \cdot \mathbf{1} = \mathbf{0}$ and so is a generator matrix.

- b. The proof is by contradiction. Suppose that in some numbering of classes $UGV = \begin{pmatrix} Q & \mathbf{0} \\ X & Y \end{pmatrix}$ and Q is a generator matrix. We renumber the states so that those that belong to classes that correspond to Q precede the other states. In this numbering, we have

$$UGV = \begin{pmatrix} U_1 & \mathbf{0} \\ \mathbf{0} & U_2 \end{pmatrix} \begin{pmatrix} G_{11} & G_{12} \\ G_{21} & G_{22} \end{pmatrix} \begin{pmatrix} V_1 & \mathbf{0} \\ \mathbf{0} & V_2 \end{pmatrix} = \begin{pmatrix} Q & \mathbf{0} \\ X & Y \end{pmatrix},$$

which in turn implies $U_1 G_{11} V_1 = Q$ and that $U_1 G_{12} V_2 = \mathbf{0}$.

We first prove that $G_{12} = \mathbf{0}$. Multiplying the equation $U_1 G_{12} V_2 = \mathbf{0}$ from the right by $\mathbf{1}$ we obtain $U_1 G_{12} \cdot \mathbf{1} = \mathbf{0}$. Define $x \in \mathbb{R}^n$ by $x = G_{12} \cdot \mathbf{1}$. Since $G_{12} \geq \mathbf{0}$, also $x \geq \mathbf{0}$. Suppose $x[k] > 0$ for some $1 \leq k \leq n$. Then from $U_1 x = \mathbf{0}$ it follows that $U[K, k] = 0$ for all $1 \leq K \leq N$. This is not possible because of the requirement that $U[K, k] > 0$ for the index K such that $V[k, K] = 1$. We conclude that $x = \mathbf{0}$ which implies $G_{12} = \mathbf{0}$.

We now prove that G_{11} is a generator matrix. Note that it is a semi-generator and so we only need to show that $G_{11} \cdot \mathbf{1} = \mathbf{0}$. Multiplying the equation $U_1 G_{11} V_1 = Q$ from the right by $\mathbf{1}$ we obtain $U_1 G_{11} \cdot \mathbf{1} = Q \cdot \mathbf{1} = \mathbf{0}$ because Q is a generator. Define $x \in \mathbb{R}^n$ by $x = G_{11} \cdot \mathbf{1}$. Note that $x \leq 0$. Suppose $x[k] < 0$ for some $1 \leq k \leq n$. Since $U_1 x = \mathbf{0}$ it follows that $U[K, k] = 0$ for all $1 \leq K \leq N$. As in the previous case, this is not possible because $U[K, k] > 0$ when $V[k, K] = 1$. We conclude that $x = \mathbf{0}$ and, therefore, that G_{11} is a generator.

The second notion we introduce is the notion of irreducible generators. A matrix is called *irreducible* if there does not exist a renumbering after which it is represented as $\begin{pmatrix} A' & A'' \\ \mathbf{0} & B \end{pmatrix}$ for some (non-empty) square matrices A' and B .

Lemma 38. *Let $Q \in \mathbb{R}^{n \times n}$ be an irreducible generator matrix. Then $UQV \in \mathbb{R}^{N \times N}$ is also an irreducible generator matrix for any collector matrix $V \in \mathbb{R}^{n \times N}$.*

$\mathbb{R}^{n \times N}$, and any distributor $U \in \mathbb{R}^{N \times n}$ associated to V such that $V[i, K] = 1$ implies $U[K, i] > 0$, for all $1 \leq i \leq n$ and $1 \leq K \leq N$.

Proof. The proof is by contradiction. Suppose that $\hat{Q} = UQV$ is not irreducible. Then $\hat{Q} = \begin{pmatrix} \hat{Q}'_1 & \hat{Q}''_1 \\ \mathbf{0} & \hat{Q}_2 \end{pmatrix}$ in some numbering of classes. After an adequate renumbering of states we have

$$UQV = \begin{pmatrix} U_1 & \mathbf{0} \\ \mathbf{0} & U_2 \end{pmatrix} \begin{pmatrix} Q'_1 & Q''_1 \\ Q'_2 & Q''_2 \end{pmatrix} \begin{pmatrix} V_1 & \mathbf{0} \\ \mathbf{0} & V_2 \end{pmatrix} = \begin{pmatrix} \hat{Q}'_1 & \hat{Q}''_1 \\ \mathbf{0} & \hat{Q}_2 \end{pmatrix}$$

which implies that $U_2 Q'_2 V_1 = \mathbf{0}$. Since $Q'_2 \geq 0$, after the same reasoning as in the proof of Lemma 37, we obtain that $Q'_2 = \mathbf{0}$. From this it follows that Q is not irreducible which is a contradiction. We conclude that \hat{Q} must be irreducible.

We are now ready for the correctness proof.

Theorem 39. Suppose $(\sigma, Q_s, Q_f, \rho) \xrightarrow{\mathcal{P}}_{\tau} (\hat{\sigma}, \hat{Q}_s, \hat{Q}_f, \hat{\rho})$, $(\sigma, Q_s, Q_f, \rho) \rightarrow_{\infty} (\sigma, \Pi, Q, \rho')$ and $(\sigma, \Pi, Q, \rho') \rightarrow_{\mathcal{P}} (\sigma, \hat{\Pi}, \hat{Q}, \hat{\rho}')$. Then

$$(\sigma, Q_s, Q_f, \rho) \rightarrow_{\infty} (\sigma, \hat{\Pi}, \hat{Q}, \hat{\rho}').$$

Proof. According to Theorem 12, we need to show that $\hat{\Pi}$ is the ergodic projection of \hat{Q}_f , that $\hat{\Pi} \hat{Q}_s \hat{\Pi} = \hat{Q}$ and that $\hat{\Pi} \hat{\rho} = \hat{\rho}'$.

For the second part, using the property $\Pi V W = \Pi V W \Pi$ proven in Lemma 36, we have the following derivations:

$$\begin{aligned} \hat{\Pi} \hat{Q}_s \hat{\Pi} &= U \Pi V W Q_s V U \Pi V = U \Pi V W \Pi Q_s \Pi V = \\ &= U \Pi \Pi Q_s \Pi V = U \Pi Q_s \Pi V = U Q V = \hat{Q}, \end{aligned}$$

and, since $\rho' = \Pi \rho$, we have $\Pi \rho' = \rho'$, and then

$$\hat{\Pi} \hat{\rho} = U \Pi V W \rho = U \Pi V W \Pi \rho = U \Pi V W \rho' = U \Pi \rho' = U \rho' = \hat{\rho}'.$$

It remains to show that $\hat{\Pi}$ is the ergodic projection of \hat{Q}_f . Recall that it is enough to show that $\hat{\Pi} \geq 0$, $\hat{\Pi} \cdot \mathbf{1} = \mathbf{1}$, $\hat{\Pi}^2 = \hat{\Pi}$, $\hat{\Pi} \hat{Q}_f = \hat{Q}_f \hat{\Pi} = \mathbf{0}$ and $\text{rank}(\hat{\Pi}) + \text{rank}(\hat{Q}_f) = N$. In Theorem 20 we showed that $\hat{\Pi}$ satisfies the conditions of Theorem 6, so we have $\hat{\Pi} \geq 0$, $\hat{\Pi} \cdot \mathbf{1} = \mathbf{1}$ and $\hat{\Pi}^2 = \hat{\Pi}$. We also derive

$$\hat{\Pi} \hat{Q}_f = U \Pi V W Q_f V = U \Pi V W \Pi Q_f V = \mathbf{0}$$

using that $\Pi Q_f = \mathbf{0}$. Similarly,

$$\hat{Q}_f \hat{\Pi} = W Q_f V U \Pi V = W Q_f \Pi V = \mathbf{0}$$

because $Q_f \Pi = \mathbf{0}$. We prove that $\text{rank}(\hat{\Pi}) + \text{rank}(\hat{Q}_f) = N$.

First, we compute $\hat{\Pi}$:

$$\hat{\Pi} = W\Pi V = \begin{pmatrix} W_1\Pi_1V_1 & \mathbf{0} & \dots & \mathbf{0} & \mathbf{0} \\ \mathbf{0} & W_2\Pi_2V_2 & \dots & \mathbf{0} & \mathbf{0} \\ \vdots & \vdots & \ddots & \vdots & \vdots \\ \mathbf{0} & \mathbf{0} & \dots & W_S\Pi_SV_S & \mathbf{0} \\ \widetilde{W}\widetilde{\Pi}_1V_1 & \widetilde{W}\widetilde{\Pi}_2V_2 & \dots & \widetilde{W}\widetilde{\Pi}_SV_S & \mathbf{0} \end{pmatrix}$$

where $W_i\Pi_iV_i = W_i \cdot \mathbf{1} \cdot \rho_i = \mathbf{1} \cdot \rho_i$.

Since $\hat{\Pi}$ is idempotent, i.e. $\hat{\Pi}^2 = \hat{\Pi}$, its rank is equal to its trace and so:

$$\text{rank}(\hat{\Pi}) = \text{trace}(\hat{\Pi}) = \sum_{i=1}^S \text{trace}(W_i\Pi_iV_i) = \sum_{i=1}^S \text{trace}(\mathbf{1} \cdot \rho_i) = S \cdot 1 = S.$$

We now show that $\text{rank}(\hat{Q}_f) = N - S$.

It is known (cf. [18]) that, in a numbering that makes the ergodic partitioning explicit (and our numbering is just a more refined one), Q_f has the following form:

$$Q_f = \begin{pmatrix} Q_1 & \mathbf{0} & \dots & \mathbf{0} & \mathbf{0} & \mathbf{0} \\ \mathbf{0} & Q_2 & \dots & \mathbf{0} & \mathbf{0} & \mathbf{0} \\ \vdots & \vdots & \ddots & \vdots & \vdots & \vdots \\ \mathbf{0} & \mathbf{0} & \dots & Q_S & \mathbf{0} & \mathbf{0} \\ \overline{Q}_1 & \overline{Q}_2 & \dots & \overline{Q}_S & \overline{Q} & \overline{Q}' \\ \widetilde{Q}_1 & \widetilde{Q}_2 & \dots & \widetilde{Q}_S & \widetilde{Q} & \widetilde{Q}' \end{pmatrix} \quad Q_i = \text{diag}(Q_{i1}, \dots, Q_{ie_i}),$$

where Q_{ij} are irreducible generators and $\begin{pmatrix} \overline{Q} & \overline{Q}' \\ \widetilde{Q} & \widetilde{Q}' \end{pmatrix}$ is an indecomposable semi-generator. Note that it follows that \widetilde{Q}' must also be an indecomposable semi-generator.

We compute \hat{Q}_f :

$$\hat{Q}_f = WQ_fV = \begin{pmatrix} W_1Q_1V_1 & \mathbf{0} & \dots & \mathbf{0} & \mathbf{0} \\ \mathbf{0} & W_2Q_2V_2 & \dots & \mathbf{0} & \mathbf{0} \\ \vdots & \vdots & \ddots & \vdots & \vdots \\ \mathbf{0} & \mathbf{0} & \dots & W_SQ_SV_S & \mathbf{0} \\ \widetilde{W} \begin{pmatrix} \widetilde{Q}_1V_1 \\ + \\ \widetilde{Q}\widetilde{V}_1 \end{pmatrix} & \widetilde{W} \begin{pmatrix} \widetilde{Q}_2V_2 \\ + \\ \widetilde{Q}\widetilde{V}_2 \end{pmatrix} & \dots & \widetilde{W} \begin{pmatrix} \widetilde{Q}_SV_S \\ + \\ \widetilde{Q}\widetilde{V}_S \end{pmatrix} & \widetilde{W}\widetilde{Q}'\widetilde{V} \end{pmatrix}$$

and

$$W_iQ_iV_i = \sum_{j=1}^{e_i} W_{ij}Q_{ij}V_{ij}.$$

Since Q_{ij} is an irreducible generator, and since W_{ij} and V_{ij} satisfy the conditions of Lemma 38, we can apply this lemma and obtain that $W_{ij}Q_{ij}V_{ij}$ is also

an irreducible generator. It follows easily that the sum of two irreducible generators is again an irreducible generator. We conclude that $W_i Q_i V_i$ is an irreducible generator.

Since \tilde{Q}' is an indecomposable semi-generator, and since \tilde{W} and \tilde{V} satisfy the conditions of Lemma 37, we apply this lemma and obtain that $\tilde{W}\tilde{Q}'\tilde{V}$ is an indecomposable semi-generator matrix.

It is known that the rank of an irreducible generator of dimension n is $n - 1$. We have also proven in Lemma 37a that an indecomposable semi-generator matrix has full rank. Then $\text{rank}(\hat{Q}_f) = \sum_{i=1}^S (c_i - 1) + N - (L + 1) + 1 = L - S + N - L = N - S$.

Recall that depending on the parameters in the τ -distributor there are, in general, many processes to which a τ -lumpable Markov reward chain with fast transitions τ -lumps to. The previous theorem showed that all these processes are equivalent up-to the limit. The next theorem shows that they are exactly the same if all fast transitions were eliminated by τ -lumping, i.e. when the matrix that models fast transitions aggregates to zero matrix.

Theorem 40. *Suppose $(\sigma, Q_s, Q_f, \rho) \xrightarrow{\mathcal{P}}_{\tau} (\hat{\sigma}, \hat{Q}_s, \hat{Q}_f, \hat{\rho})$ and suppose W is the τ -distributor used. Suppose $\hat{Q}_f = \mathbf{0}$. Let W' be a τ -distributor with a different choice for parameters. Then $W'Q_sV = \hat{Q}_s$, $W'Q_fV = \mathbf{0}$ and $W'\rho = \hat{\rho}$.*

Proof. Let $(\sigma, Q_s, Q_f, \rho) \rightarrow_{\infty} (\sigma, \Pi, Q, \Pi\rho)$. Since $\hat{Q}_f = WQ_fV = \mathbf{0}$, by Theorem 39 we have $W\Pi V = I$. Multiplying by V from the left and using that $VW\Pi V = \Pi V$, we obtain $\Pi V = V$. From Lemma 36, we have that $\Pi V W \Pi = \Pi V W$ and $\Pi V W' \Pi = \Pi V W'$. Since $\Pi V = V$, we have $VW\Pi = VW$ and $VW'\Pi = VW'$. Multiplying by W from the left, we get $W\Pi = W$ and $W'\Pi = W'$.

First, $W'Q_fV = W'\Pi Q_fV = \mathbf{0}$ because $\Pi Q_f = \mathbf{0}$ (as Π is the ergodic projection of Q_f). Next, using that UQV is the same for any distributor U , we have $\hat{Q}_s = WQ_sV = W\Pi Q_s\Pi V = WQV = W'QV = W'\Pi Q_s\Pi V = W'Q_sV$. Similarly, $W\rho = W\Pi\rho = W'\Pi\rho = W'\rho$.

3.3 τ_{\sim} -lumping

In this section we introduce a notion of lumping for Markov reward chains with silent transitions, called τ_{\sim} -lumping, by lifting τ -lumping to equivalence classes induced by the relation \sim (recall Definition 15). Intuitively, we want a partitioning \mathcal{P} of a Markov reward chain with silent transitions $(\sigma, Q_s, [Q_f]_{\sim}, \rho)$ to be a τ_{\sim} -lumping iff it is a τ -lumping for any Markov reward chain with fast transitions $(\sigma, Q_s, Q'_f, \rho)$ with $Q'_f \sim Q_f$. Moreover, to have a proper lifting, we also want $\hat{Q}_s = WQ_sV$ and $\hat{\rho} = W\rho$ not to depend on the choice for the representative from $[Q_f]_{\sim}$. This is crucial for the definition of the τ_{\sim} -lumped process.

Before we give a definition that satisfies the above requirements, we give an example that shows that not every τ -lumping can be taken for τ_{\sim} -lumping.

- Example 41.* a. Consider the Markov reward chain with silent transitions depicted in Figure 10a. Example 32b shows that the partitioning $\mathcal{P} = \{\{1, 2\}, \{3\}\}$ is a τ -lumping for all possible speeds given to the silent transitions. However, the slow transition in the τ -lumped process always depends on those speeds.
- b. Consider the Markov reward chain with silent transitions depicted in Figure 10b. The Example 34c shows, that although for some speeds the partitioning $\{\{1, 2\}, \{3\}, \{4\}\}$ is a τ -lumping, it need not be so for some other speeds.

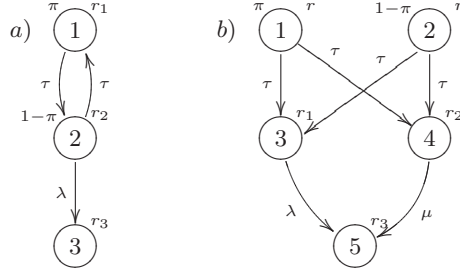

Fig. 10. Not every τ -lumping can be τ_{\sim} -lumping – Example 41

For the definition of τ_{\sim} -lumping we need to introduce some notation. We define $\text{erg}(i) = \{j \in E \mid i \rightarrow j\}$ to be the set of all ergodic states reachable from state i and, for $X \subseteq \{1, \dots, n\}$, we define $\text{erg}(X) = \bigcup_{i \in X} \text{erg}(i)$. Note that $j \in \text{erg}(i)$ iff $\Pi[i, j] > 0$. Let E_L be some ergodic class. Then, for $i \in E_L$, we have $\text{erg}(i) = E_L$. Recall that $\delta_L[i] > 0$ iff $i \in T$ can be trapped in E_L . Therefore, $\delta_L[i] = 1$ iff $\text{erg}(i) = E_L$.

Now, carefully restricting to the cases when τ -lumping is “speed independent”, i.e. forbidding the situations from Example 41, we define τ_{\sim} -lumping as follows.

Definition 42 (τ_{\sim} -lumping). Let $(\sigma, Q_s, [Q_f]_{\sim}, \rho)$ be a Markov reward chain with silent transitions. Let $\{E_1, \dots, E_M, T\}$ be its ergodic partitioning and let $E = \bigcup_{1 \leq k \leq M} E_k$ be the set of ergodic states. A partitioning \mathcal{P} is a τ_{\sim} -lumping of $(\sigma, Q_s, [Q_f]_{\sim}, \rho)$ iff:

1. for all $C \in \mathcal{P}$ at least one of the following holds:
 - (a) $\text{erg}(C) \subseteq D$, for some $D \in \mathcal{P}$,
 - (b) $\text{erg}(C) = E_L$, for some $1 \leq L \leq M$, or
 - (c) $C \subseteq T$ and $i \rightarrow i'$, for exactly one $i \in C$ and some $i' \notin C$;
2. for all $C \in \mathcal{P}$, all $i, j \in C \cap E$ and all $D \in \mathcal{P}$, such that $C \neq D$, $\sum_{\ell \in D} Q_s[i, \ell] = \sum_{\ell \in D} Q_s[j, \ell]$ holds;
3. for all $i, j \in C \cap E$, $\rho[i] = \rho[j]$ holds.

Let us explain what these conditions mean. Condition 1 ensures that the lumping condition holds for the ergodic projection Π of any matrix from $[Q_f]_{\sim}$. Condition 1a says that the ergodic states reachable by silent transitions from the states in C are all in the same lumping class. Condition 1b says that the ergodic states reachable by silent transitions from the states in C constitute an ergodic class. Condition 1c says that C is a set of transient states with precisely one (silent) exit. Note that Conditions 1a and 1b overlap when $E_i \subseteq D$. If, in addition, C contains only transient states and has only one exit, all the three conditions overlap. Condition 1 forbids lumping classes to contain parts of different ergodic classes in order to eliminate the effect of the ergodic probabilities. It also forbids the case where transient states of some lumping class lead to multiple ergodic classes that are not all subsets of some lumping class (except in the case where there are only transient states in the lumping class and the class has only one exit). This is to eliminate the effect of the trapping probabilities. Note that in the exceptional case the trapping probabilities of all the elements from the lumping class are all equal. Note that Condition 1 was violated in Example 41b. This is because states 3 and 4 were not in a lumping class nor in an ergodic class, and because the lumping class $\{1, 2\}$ has two exits.

Condition 2 says that every ergodic state in C must have the same accumulative rate to every other τ_{\sim} -lumping class. This condition is needed to avoid the situation in Example 41a where a slow transition in the τ -lumped process depends on speeds. Condition 3 says that every ergodic state that belongs to the same lumping class must have the same reward. The idea is the same as in Condition 2 but applied for the reward vector. The condition ensures that the rewards in the lumped process do not depend on speeds. Note that no condition is imposed on Q_s and ρ that concerns transient states.

We now show that the notion of τ_{\sim} -lumping from Definition 42 exactly meets our requirements set in the beginning.

Theorem 43. *Let $(\sigma, Q_s, [Q_f]_{\sim}, \rho)$ be a Markov reward chain with silent transitions and let \mathcal{P} be a partitioning. Then \mathcal{P} is a τ_{\sim} -lumping iff it is a τ -lumping for every Markov reward chain with fast transitions (σ, Q_s, Q_f, ρ) with $Q_f \in [Q_f]_{\sim}$ and, moreover, for any $Q'_f \sim Q_f$, $W'Q_sV = WQ_sV$ and $W'\rho = W\rho$, where W and W' are τ -distributors for Q_f and Q'_f respectively, and have the same values for the free parameters.*

Proof. (\Rightarrow) We first show that \mathcal{P} is a τ -lumping for all representative matrices Q_f . Recall that $VU\Pi V = \Pi V$ is equivalent to the condition that the rows of ΠV that correspond to the states that belong to the same partitioning class are equal. This is the same as saying that, for all $C, D \in \mathcal{P}$, $\sum_{d \in D} \Pi[i, d] = \sum_{d \in D} \Pi[j, d]$ for all $i, j \in C$.

Suppose first that Condition 1a holds, i.e. that $\text{erg}(C) \subseteq C'$ for some $C' \in \mathcal{P}$. Then, for all $i \in C$, $\text{erg}(i) \subseteq C'$. From this, by a simple contradiction, it follows that $\Pi[i, d] = 0$ for all $d \in D$ where $D \neq C'$. Then, for such D , we have $\sum_{d \in D} \Pi[i, d] = 0 = \sum_{d \in D} \Pi[j, d]$. Since Π is a stochastic matrix, its rows sum up to one, and so we also have $\sum_{c \in C'} \Pi[i, c] = 1 = \sum_{c \in C'} \Pi[j, c]$.

Suppose that Condition 1b holds, i.e. that $\text{erg}(C) = E_L$ for some $1 \leq L \leq M$. Then, for all $i \in C$, $\text{erg}(i) \subseteq E_L$. Again by a simple contradiction, we obtain $\Pi[i, d] = 0$ for all $d \in D$ such that $D \cap E_L = \emptyset$. From the form of Π it follows that, for such D , $\sum_{d \in D} \Pi[i, d] = 0 = \sum_{d \in D} \Pi[j, d]$ for all $i, j \in C$. Let now $i \in C$ and let some class $D \in \mathcal{P}$ satisfy $D \cap E_L \neq \emptyset$. Then we distinguish two cases. Suppose first that $i \in E$. Since $\text{erg}(i) \subseteq E_L$, we have $i \in E_L$. Then $\sum_{d \in D} \Pi[i, d] = \sum_{d \in D \cap E_L} \Pi[i, d] = \sum_{d \in D} \Pi[d, d]$. Suppose now that $i \in T$. Then from $\text{erg}(i) \subseteq E_L$ we obtain that $\delta_L[i] = 1$. Now, $\sum_{d \in D} \Pi[i, d] = \sum_{d \in D \cap E_L} \delta_L[i] \Pi[i, d] = \sum_{d \in D} \Pi[d, d]$. Finally, we have $\sum_{d \in D} \Pi[i, d] = \sum_{d \in D} \Pi[d, d] = \sum_{d \in D} \Pi[i, d]$ for all $i, j \in C$.

Assume now that Condition 1c holds. Let $i \in C$ be the only state in $C \subseteq T$ such that $i \rightarrow i'$ for some $i' \notin C$. Let $j \in C$ be arbitrary. Then, because $C \subseteq T$, we have $j \rightarrow i$. Note that this implies that $\delta_L[i] = \delta_L[j]$, for all $1 \leq L \leq M$. Using this, we have $\sum_{d \in D} \Pi[i, d] = \sum_{d \in E} \Pi[i, d] = \sum_{d \in E} \delta_L(i) \Pi[d, d] = \sum_{d \in E} \delta_L(j) \Pi[d, d] = \sum_{d \in D} \Pi[j, d]$.

To show that $VU\Pi Q_s \Pi V = \Pi Q_s \Pi V$ and $VU\Pi \rho = \Pi \rho$ we use matrix manipulation. Let the numbering be such that it makes the division between ergodic and transient states explicit. Moreover, let the lumping classes be rearranged so that the classes that contain ergodic states precede those that contain only transient states. This renumbering gives the following forms for Π , Q_s , ρ and V :

$$\Pi = \begin{pmatrix} \Pi_E & \mathbf{0} \\ \Pi_T & \mathbf{0} \end{pmatrix}, \quad Q_s = \begin{pmatrix} Q_E & Q_{ET} \\ Q_{TE} & Q_T \end{pmatrix}, \quad \rho = \begin{pmatrix} \rho_E \\ \rho_T \end{pmatrix}, \quad V = \begin{pmatrix} V_E & \mathbf{0} \\ V_{TE} & V_T \end{pmatrix}.$$

Note that

$$\Pi Q_s = \begin{pmatrix} \Pi_E Q_E & \Pi_E Q_{ET} \\ \Pi_T Q_E & \Pi_T Q_{ET} \end{pmatrix} = \Pi \begin{pmatrix} Q_E & Q_{ET} \\ \mathbf{0} & \mathbf{0} \end{pmatrix}, \quad \Pi \rho = \begin{pmatrix} \Pi_E \rho_E \\ \Pi_T \rho_E \end{pmatrix} = \Pi \begin{pmatrix} \rho_E \\ \mathbf{0} \end{pmatrix}$$

and

$$\Pi V = \begin{pmatrix} \Pi_E V_E & \mathbf{0} \\ \Pi_T V_E & \mathbf{0} \end{pmatrix} = \Pi \begin{pmatrix} V_E & \mathbf{0} \\ \mathbf{0} & \mathbf{0} \end{pmatrix}.$$

Condition 2 of Definition 42 imposes the lumping condition only on ergodic states. It can be rewritten in matrix form as:

$$V_E U_E (Q_E \ Q_{ET}) V = (Q_E \ Q_{ET}) V,$$

where U_E is a distributor matrix corresponding to (the collector matrix) V_E . Using that $VU\Pi V = \Pi V$ we compute:

$$\begin{aligned} VUQV &= VU\Pi Q_s \Pi V = VU\Pi \begin{pmatrix} Q_E & Q_{ET} \\ \mathbf{0} & \mathbf{0} \end{pmatrix} \Pi V = \\ &= VU\Pi \begin{pmatrix} Q_E & Q_{ET} \\ \mathbf{0} & \mathbf{0} \end{pmatrix} VU\Pi V = VU\Pi \begin{pmatrix} V_E U_E Q_E & V_E U_E Q_{ET} \\ \mathbf{0} & \mathbf{0} \end{pmatrix} VU\Pi V = \\ &= VU\Pi \begin{pmatrix} V_E & \mathbf{0} \\ \mathbf{0} & \mathbf{0} \end{pmatrix} \begin{pmatrix} U_E Q_E & U_E Q_{ET} \\ \mathbf{0} & \mathbf{0} \end{pmatrix} VU\Pi V = VU\Pi V \begin{pmatrix} U_E Q_E & U_E Q_{ET} \\ \mathbf{0} & \mathbf{0} \end{pmatrix} VU\Pi V = \\ &= \Pi V \begin{pmatrix} U_E Q_E & U_E Q_{ET} \\ \mathbf{0} & \mathbf{0} \end{pmatrix} VU\Pi V = \Pi Q_s \Pi V = QV. \end{aligned}$$

Condition 3 of Definition 42 is written in matrix form as:

$$V_E U_E \rho_E = \rho_E.$$

Similarly as we did for Q , we compute

$$\begin{aligned} VU\Pi\rho &= VU\Pi\left(\begin{smallmatrix} \rho_E \\ \mathbf{0} \end{smallmatrix}\right) = VU\Pi\left(\begin{smallmatrix} V_E U_E \rho_E \\ \mathbf{0} \end{smallmatrix}\right) = VU\Pi\left(\begin{smallmatrix} V_E & \mathbf{0} \\ \mathbf{0} & \mathbf{0} \end{smallmatrix}\right)\left(\begin{smallmatrix} U_E \rho_E \\ \mathbf{0} \end{smallmatrix}\right) = \\ &= VU\Pi V\left(\begin{smallmatrix} U_E \rho_E \\ \mathbf{0} \end{smallmatrix}\right) = \Pi V\left(\begin{smallmatrix} U_E \rho_E \\ \mathbf{0} \end{smallmatrix}\right) = \Pi\left(\begin{smallmatrix} V_E U_E \rho_E \\ \mathbf{0} \end{smallmatrix}\right) = \Pi\left(\begin{smallmatrix} \rho_E \\ \mathbf{0} \end{smallmatrix}\right) = \Pi\rho. \end{aligned}$$

We show that \hat{Q}_s does not depend on the representative Q_f . We have $\hat{Q}_s = WQ_s V$ for some τ -distributor W . Suppose we take Q'_f instead of Q_f and let W' be the τ -distributor for Q'_f that has the same parameters as W . We show that $\hat{Q}_s = W'Q_s V$.

In the same renumbering as before the matrices W and W' have the following form:

$$W = \begin{pmatrix} W_E & \mathbf{0} \\ \mathbf{0} & W_T \end{pmatrix} \quad \text{and} \quad W' = \begin{pmatrix} W'_E & \mathbf{0} \\ \mathbf{0} & W_T \end{pmatrix}.$$

Note that W and W' have the same block that corresponds to the classes that contain only transient states. This is because this block only depends on the parameters and not on Q_f . Now,

$$W\left(\begin{smallmatrix} \mathbf{0} & \mathbf{0} \\ Q_{TE} & Q_T \end{smallmatrix}\right) = W'\left(\begin{smallmatrix} \mathbf{0} & \mathbf{0} \\ Q_{TE} & Q_T \end{smallmatrix}\right).$$

Since W_E and W'_E are distributors for V_E , we also have

$$W_E(Q_E \ Q_{ET})V = W'_E(Q_E \ Q_{ET})V,$$

which implies

$$W\left(\begin{smallmatrix} Q_E & Q_{ET} \\ \mathbf{0} & \mathbf{0} \end{smallmatrix}\right)V = W'\left(\begin{smallmatrix} Q_E & Q_{ET} \\ \mathbf{0} & \mathbf{0} \end{smallmatrix}\right)V.$$

We now compute:

$$\begin{aligned} \hat{Q}_s &= WQ_s V = W\left(\begin{smallmatrix} Q_E & Q_{ET} \\ Q_{TE} & Q_T \end{smallmatrix}\right)V = W\left(\begin{smallmatrix} Q_E & Q_{ET} \\ \mathbf{0} & \mathbf{0} \end{smallmatrix}\right)V + W\left(\begin{smallmatrix} \mathbf{0} & \mathbf{0} \\ Q_{TE} & Q_T \end{smallmatrix}\right)V = \\ &= W'\left(\begin{smallmatrix} Q_E & Q_{ET} \\ \mathbf{0} & \mathbf{0} \end{smallmatrix}\right)V + W'\left(\begin{smallmatrix} \mathbf{0} & \mathbf{0} \\ Q_{TE} & Q_T \end{smallmatrix}\right)V = W'Q_s V = \hat{Q}'_s. \end{aligned}$$

To show that the reward vector of the lumped process does not depend on the representative Q_f note that $V_E U_E \rho_E = \rho_E$. From this it follows that $W_E \rho_E = W'_E \rho_E$ which directly implies

$$W\rho = \begin{pmatrix} W_E \rho_E \\ W_T \rho_T \end{pmatrix} = \begin{pmatrix} W'_E \rho_E \\ W_T \rho_T \end{pmatrix} = W'\rho.$$

(\Leftarrow) First we show that Conditions 1a, 1b and 1c must hold if the lumping condition on Π is to hold for every Q_f from $[Q_f]_{\sim}$. Let $C \in \mathcal{P}$. We distinguish two cases, when $C \cap E \neq \emptyset$ and when $C \subseteq T$.

Suppose $C \cap E \neq \emptyset$. Let the ergodic classes be arranged so that there is a $1 \leq P \leq M$ such that $E_K \cap C \neq \emptyset$ for $K \leq P$, and $E_K \cap C = \emptyset$ for $K \geq P + 1$. Since Condition, 1b does not hold, we have $P \geq 2$. We show that not $E_K \subseteq C$ for all $1 \leq K \leq P$.

Assume that $C \subseteq E$. Then $E_K \subseteq C$ for all $1 \leq K \leq P$. This implies that $\text{erg}(C) \subseteq C$ which is not possible since Condition 1a does not hold. Suppose now

that $C \cap T \neq \emptyset$ and let $i \in C \cap T$. We show that $\text{erg}(i) \subseteq C$. Suppose not. Then there is an $k \in E$ such that $i \rightarrow k$ and $k \notin (E_1 \cup \dots \cup E_P)$. Let $D \in \mathcal{P}$ be such that $k \in D$ and let $\ell \in E_L$ for some $1 \leq L \leq P$. Then $\sum_{d \in D} \Pi[i, d] > 0$ and $\sum_{d \in D} \Pi[\ell, d] = 0$, and so the lumping condition does not hold. We conclude that $\text{erg}(i) \subseteq C$. From this it follows that $\text{erg}(C) \subseteq C$ which is impossible because Condition 1a does not hold. We conclude that not $E_K \subseteq C$ for all $1 \leq K \leq P$.

Let $1 \leq I, J \leq P$ be such that $E_I \cap C \neq \emptyset$, $E_K \cap C \neq \emptyset$ and $E_I \not\subseteq C$. Then there is a $D \in \mathcal{P}$ such that $E_I \cap D \neq \emptyset$. By Lemma 27 it follows that $E_I \cap D \neq \emptyset$. Let $i \in C \cap E_I$. Then $\sum_{d \in D} \Pi[i, d] = \sum_{d \in D} \Pi[i, d] \neq 0, 1$. Similarly, for $j \in C \cap E_I$ we have $\sum_{d \in D} \Pi[j, d] = \sum_{d \in D} \Pi[j, d] \neq 0, 1$. Now, we can always choose a Q_f so that the ergodic probabilities of E_I and E_J are such that $\sum_{d \in D} \Pi[i, d] \neq \sum_{d \in D} \Pi[j, d]$.

Suppose now that $C \subseteq T$. Let $i_1, \dots, i_p \in C$ be such that, for all $1 \leq k \leq p$, we have $i_k \rightarrow i'_k$ for some $i'_k \notin C$. Note that it is not possible to have a $C' \in \mathcal{P}$ such that $\text{erg}(i_k) \subseteq C'$ for all $1 \leq k \leq p$ because this would imply $\text{erg}(C) \subseteq C'$ which does not hold. Let $i, j \in \{i_1, \dots, i_p\}$ and $D, F \in \mathcal{P}$, $D \neq F$, be such that $i \rightarrow i' \in E \cap D$ and $j \rightarrow j' \in E \cap F$. If there is no $i'' \in F \cap E$ such that $i \rightarrow i''$, then $\sum_{f \in F} \Pi[i, f] = 0$ while $\sum_{f \in F} \Pi[j, f] > 0$. Similarly, if there is no $j'' \in D \cap E$ such that $j \rightarrow j''$, we have $\sum_{d \in D} \Pi[j, d] = 0$ while $\sum_{d \in D} \Pi[i, d] > 0$. Now, suppose $i \rightarrow i'' \in E \cap F$ and $j \rightarrow j'' \in E \cap D$. Then we can always choose a Q_f to obtain trapping probabilities so that $\sum_{d \in D} \Pi[i, d] \neq \sum_{d \in D} \Pi[j, d]$.

We conclude that Condition 1 holds. Using this, we now only show that Condition 3 holds. For Condition 2 the proof is essentially the same and is omitted.

Let $C_K \in \mathcal{P}$, let $i, j \in C \cap E$ and let $i \in E_I$ and $j \in E_J$ for some ergodic classes E_I and E_J . From what we proved before it follows that $E_I \subseteq C$ and $E_J \subseteq C$. We distinguish two cases, when $I = J$ and when $I \neq J$.

Suppose $I = J$. Let W be a τ -distributors associated to Q_f such that the parameters α_{JL} in Definition 30 are equal to $\frac{1}{e_J}$. Then

$$(W\rho)[K] = \sum_{k \in C_K} W[K, k] \rho[k] = \sum_{k \in C_K \cap E} \frac{\Pi[k, k]}{\sum_{\ell \in C_K} \Pi[\ell, \ell]} \rho_k.$$

Define Π' to be the same as Π but with $\Pi'[\ell, i] = \Pi[\ell, i] + \varepsilon$ for all $\ell \in E_I$, and $\Pi'[\ell, j] = \Pi[\ell, j] - \varepsilon$ for all $\ell \in E_J$, where $0 < \varepsilon < \Pi[j, j]$. Clearly, Π' is of the right form and it satisfies the lumping condition because $E_I = E_J \subseteq C$. We can always find $Q'_f \sim Q_f$ that has Π' as its ergodic projection. Let W' be a τ -distributors associated to Q'_f again such that the parameters α_{JL} are all the same. After some simple calculation, we obtain that $(W'\rho)[K] - (W\rho)[K] = \varepsilon(\rho[i] - \rho[j])$. Therefore, if $\rho[i] \neq \rho[j]$, then $(W\rho)[K] \neq (W'\rho)[K]$. We conclude that $\rho[i] = \rho[j]$.

Suppose now that $I \neq J$. If $|E_I| = |E_J| = 1$, then

$$(\Pi\rho)[i] = \sum_k \Pi[i, k] \rho[k] = \sum_{k \in E_I} \Pi[i, k] \rho[k] = \rho[i]$$

and similarly $(\Pi\rho)[j] = \rho[j]$. Therefore, $\rho[i] = \rho[j]$. Suppose $|E_I| > 1$. We define a matrix Π' to be the same as Π except that $\Pi'[k, i] = \Pi[k, i] + \varepsilon$ for all $k \in E_I$, and $\Pi'[\ell, j] = \Pi[\ell, j] - \varepsilon$ for all $\ell \in E_J$, with $0 < \varepsilon < \Pi[j, j]$. As before it easily follows that the lumping condition still holds for Π' and that Π' is of the right form. Now, since $(\Pi\rho)[i] = (\Pi\rho)[j]$, $(\Pi'\rho)[i] = (\Pi'\rho)[j]$ and $(\Pi'\rho)[j] = (\Pi\rho)[j]$, we have $(\Pi'\rho)[i] = (\Pi\rho)[i]$. From this it easily follows that $\rho[\ell] = \rho[i]$ for all $\ell \in E_I$. Then, if $|E_J| = 1$, we have $\rho[i] = \rho[\ell]$. If not, with the same reasoning as for E_I , we can obtain that $\rho[\ell] = \rho[j]$, for all $\ell \in E_J$. Now,

$$\begin{aligned} \rho[i] &= \rho[i] \sum_{k \in E_I} \Pi[i, k] = \sum_{k \in C_K} \Pi[i, k] \rho[k] = \\ &= \sum_{k \in C_K} \Pi[j, k] \rho[k] = \sum_{k \in E_J} \Pi[j, k] \rho[k] = \rho[j] \sum_{k \in E_I} \Pi[j, k] = \rho[j]. \end{aligned}$$

Now, if \mathcal{P} is a τ_{\sim} -lumping and if $(\sigma, Q_s, Q_f, \rho) \xrightarrow{\mathcal{P}}_{\tau} (\hat{\sigma}, \hat{Q}_s, \hat{Q}_f, \hat{\rho})$, then we say that $(\sigma, Q_s, [Q_f]_{\sim}, \rho)$ τ_{\sim} -lumps to $(\hat{\sigma}, \hat{Q}_s, [\hat{Q}_f]_{\sim}, \hat{\rho})$ (with respect to \mathcal{P}) and denote it by $(\sigma, Q_s, [Q_f]_{\sim}, \rho) \xrightarrow{\mathcal{P}}_{\tau_{\sim}} (\hat{\sigma}, \hat{Q}_s, [\hat{Q}_f]_{\sim}, \hat{\rho})$. Note that, as for τ -lumping, there can be several Markov reward chains with silent transitions to which $(\sigma, Q_s, [Q_f]_{\sim}, \rho)$ τ_{\sim} -lumps to.

Remark 44. Strictly speaking, for the definition of τ_{\sim} -lumping to be considered correct we must also require that $WQ_fV \sim W'Q_fV$, and that the non-zero elements of WQ_fV range over all positive numbers. The proof of this is easy (follows from $W' \sim W$ and the fact that non-zero elements in Π can take any value less than 1), however cumbersome, and is therefore omitted.

We give some examples of τ_{\sim} -lumpings.

Example 45. Consider the Markov reward chains with silent transitions depicted in Figure 11. For each of them we give a τ_{\sim} -lumping and for each lumping class we show which option of Condition 1 of Definition 42 holds. The corresponding lumped Markov reward chains with silent transitions are depicted in Figure 12.

- a. For the Markov reward chain with silent transitions depicted in Figure 11a the partitioning $\mathcal{P} = \{\{1, 2\}, \{3\}\}$ is a τ_{\sim} -lumping. For the lumping class $\{1, 2\}$ Condition 1a in Definition 42 is satisfied. For the class $\{3\}$ both Conditions 1a and 1b are satisfied.
- b. For the Markov reward chain with silent transitions in Figure 11b $\mathcal{P} = \{\{1, 2\}, \{3\}\}$ is a τ_{\sim} -lumping. For both lumping classes Conditions 1a and 1b are satisfied.
- c. For the Markov reward chain with silent transitions in Figure 11c $\mathcal{P} = \{\{1, 2\}, \{3\}, \{4\}\}$ is a τ_{\sim} -lumping. For the lumping classes $\{1, 2\}$ and $\{4\}$ both Conditions 1a and 1b are satisfied. For the class $\{3\}$ only Condition 1b is satisfied. Note that the partitioning $\mathcal{P} = \{\{1, 2, 3\}, \{4\}\}$ is not a τ_{\sim} -lumping because it violates Condition 3.

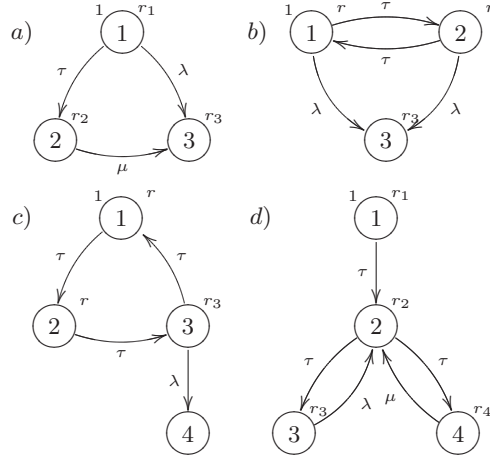

Fig. 11. Markov reward chains with silent transitions with non-trivial τ_{\sim} -lumpings – Example 45

d. For the Markov reward chain with silent transitions in Figure 11d $\mathcal{P} = \{\{1, 2\}, \{3\}, \{4\}\}$ is a τ_{\sim} -lumping. For the classes $\{3\}$ and $\{4\}$ both Conditions 1a and 1b are satisfied. Since $\{1, 2\}$ contains only transient states, for this class only Condition 1c is satisfied.

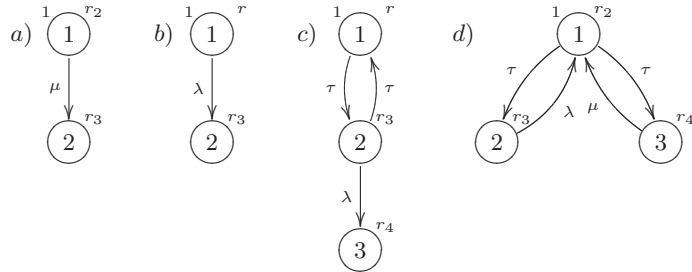

Fig. 12. τ_{\sim} -lumped Markov reward chains with silent transitions – Example 45

4 Aggregation by Reduction

In this section we first consider the specific aggregation (and disaggregation) method of [18, 19] and extend it with rewards. This method reduces a discontinuous Markov chain to a Markov chain, eliminating instantaneous states while keeping the same distributions on the set of regular states. Next, we directly

adapt this method for the setting of Markov reward chains with fast transitions. We call this method τ -reduction as it eliminates all fast transitions and reduces a Markov reward chain with fast transitions to a Markov reward chain. We develop two corresponding methods in the setting of Markov reward chains with silent transitions; the first is called τ_{\sim} -reduction and the second is *total* τ_{\sim} -reduction.

4.1 Reduction to a Markov reward chain

The reduction of a discontinuous Markov reward chain to a Markov reward chain of [18, 19] requires the notion of canonical product decomposition. We recall the definition as given in [19]:

Definition 46 (Canonical product decomposition). *Let (σ, Π, Q) be a discontinuous Markov chain with the numbering that makes the ergodic partitioning explicit. The canonical product decomposition of Π is given by the matrices $L \in \mathbb{R}^{M \times n}$ and $R \in \mathbb{R}^{n \times M}$, defined as follows:*

$$L = \begin{pmatrix} \mu_1 & \mathbf{0} & \dots & \mathbf{0} & \mathbf{0} \\ \mathbf{0} & \mu_2 & \dots & \mathbf{0} & \mathbf{0} \\ \vdots & \vdots & \ddots & \vdots & \vdots \\ \mathbf{0} & \mathbf{0} & \dots & \mu_M & \mathbf{0} \end{pmatrix} \quad R = \begin{pmatrix} \mathbf{1} & \mathbf{0} & \dots & \mathbf{0} \\ \mathbf{0} & \mathbf{1} & \dots & \mathbf{0} \\ \vdots & \vdots & \ddots & \vdots \\ \mathbf{0} & \mathbf{0} & \dots & \mathbf{1} \\ \delta_1 & \delta_2 & \dots & \delta_M \end{pmatrix}.$$

Note that $RL = \Pi$ and $LR = I$.

In case the numbering does not make the ergodic partitioning explicit, we need to renumber the states first, then construct L and R , and then renumber back to the original numbering. An example follows.

Example 47. a. Let

$$\Pi = \begin{pmatrix} 1-p & p & 0 \\ 1-p & p & 0 \\ 0 & 0 & 1 \end{pmatrix}.$$

The numbering is as needed and we obtain

$$L = \begin{pmatrix} 1-p & p & 0 \\ 0 & 0 & 1 \end{pmatrix} \quad \text{and} \quad R = \begin{pmatrix} 1 & 0 \\ 1 & 0 \\ 0 & 1 \end{pmatrix}.$$

b. Let now

$$\Pi = \begin{pmatrix} 0 & p & 1-p & 0 \\ 0 & 1 & 0 & 0 \\ 0 & 0 & 1 & 0 \\ 0 & 0 & 0 & 1 \end{pmatrix}$$

This numbering does not make the ergodic partitioning explicit. We renumber states to obtain

$$\Pi' = \begin{pmatrix} 1 & 0 & 0 & 0 \\ 0 & 1 & 0 & 0 \\ 0 & 0 & 1 & 0 \\ p & 1-p & 0 & 0 \end{pmatrix}.$$

From this,

$$L' = \begin{pmatrix} 1 & 0 & 0 & 0 \\ 0 & 1 & 0 & 0 \\ 0 & 0 & 1 & 0 \end{pmatrix} \quad \text{and} \quad R' = \begin{pmatrix} 1 & 0 & 0 \\ 0 & 1 & 0 \\ 0 & 0 & 1 \\ p & 1-p & 0 \end{pmatrix}.$$

After the renumbering back we have

$$L = \begin{pmatrix} 0 & 1 & 0 & 0 \\ 0 & 0 & 1 & 0 \\ 0 & 0 & 0 & 1 \end{pmatrix} \quad \text{and} \quad R = \begin{pmatrix} p & 1-p & 0 \\ 1 & 0 & 0 \\ 0 & 1 & 0 \\ 0 & 0 & 1 \end{pmatrix}.$$

The method of [18, 19] masks the stochastic discontinuity in a discontinuous Markov chain (σ, Π, Q, ρ) and transforms it into a standard Markov chain that has the same behavior in regular states. We extend this method with an initial probability vector and with a reward vector. The reduced Markov reward chain $(\hat{\sigma}, I, \hat{Q}, \hat{\rho})$ is defined by

$$\hat{\sigma} = \sigma R, \quad \hat{Q} = LQR \quad \text{and} \quad \hat{\rho} = L\rho.$$

The states of the simplified process are exactly the ergodic classes of the original process. The transient states are eliminated. Intuitively, they are split probabilistically between the ergodic classes according to their trapping probabilities. In case a transient state is also an initial state, the initial state probabilities are split according to their trapping probabilities. Similarly, the joined reward is the sum of the individual rewards from the ergodic class weighted by their ergodic probabilities.

The transition matrix of the aggregated process has been shown in [19] to satisfy $\hat{P}(t) = LP(t)R = e^{LQRt}$, for $t > 0$. Since $\Pi P(t) = P(t)\Pi = P(t)$, if Π of the original process is known and if $\sigma\Pi = \sigma$, there is a disaggregation procedure $\sigma = \hat{\sigma}R$, $P(t) = R\hat{P}(t)L$ and $\rho = R\hat{\rho}$.

Like lumping, the reduction procedure also preserves the total reward: $\hat{R}(t) = \hat{\sigma}\hat{P}(t)\hat{\rho} = \sigma RLP(t)RL\rho = \sigma\Pi P(t)\Pi\rho = \sigma P(t)\rho = R(t)$.

In case the original process has no stochastic discontinuity, i.e. $\Pi = I$, the aggregated process is equal to the original since then $L = R = I$.

We now recall the discontinuous Markov reward chains from Example 10 and give their reduced versions.

Example 48. a. The discontinuous Markov reward chain from Example 10a is already a Markov reward chain and so it remains intact after the reduction (cf. Figure 13a).

- b. Consider the discontinuous Markov chain from Example 10b. The matrix Π is the one from Example 47a which gives us L and R . Now,

$$\hat{\sigma} = \sigma R = (1 \ 0), \quad \hat{\rho} = L\rho = \begin{pmatrix} (1-p)r_1 + pr_2 \\ r_3 \end{pmatrix}$$

and $\hat{Q} = LQR = \begin{pmatrix} -p\lambda & p\lambda \\ 0 & 0 \end{pmatrix}$. The reduced Markov reward chain $(\hat{\sigma}, I, \hat{Q}, \hat{\rho})$ is depicted in Figure 13b.

- c. Consider the discontinuous Markov chain from Example 10c. The matrix Π of this process is the one from Example 47b which gives us L and R . We have

$$\hat{\sigma} = (p \ 1-p \ 0), \quad \hat{Q} = \begin{pmatrix} -\lambda & 0 & \lambda \\ 0 & -\mu & \mu \\ p\nu & (1-p)\nu & -\nu \end{pmatrix} \quad \text{and} \quad \hat{\rho} = \begin{pmatrix} r_2 \\ r_3 \\ r_4 \end{pmatrix}.$$

The Markov reward chain $(\hat{\sigma}, I, \hat{Q}, \hat{\rho})$ is depicted in Figure 13c.

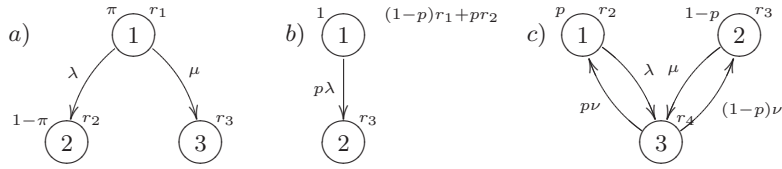
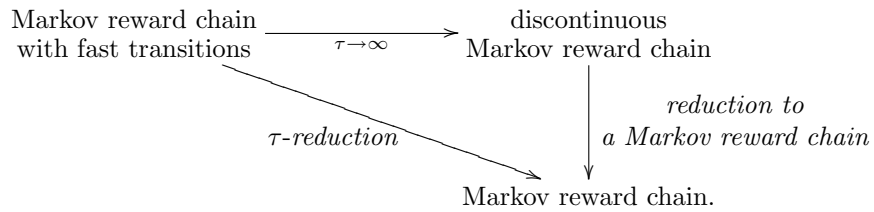

Fig. 13. Markov reward chains obtained by reduction - Example 48

4.2 τ -reduction

Recall that in the part on lumping we were justifying all operations only in the limit. We do the same here for the reduction method. We adapt the aggregation method from the previous section to reduce a Markov reward chain with fast transitions to an asymptotically equivalent Markov chain. The τ -reduced Markov reward chain with fast transitions is defined to be the Markov chain obtained by reducing the limit discontinuous Markov chain. The definition is clarified by the following diagram:



Note that, if $(\sigma, \Pi, Q, \Pi\rho)$ is the limit of (σ, Q_s, Q_f, ρ) , then we have the following derivations:

$$LQR = L\Pi Q_s \Pi R = LQ_s R \quad \text{and} \quad L\Pi\rho = L\rho.$$

Using this we have the following definition for τ -reduction.

Definition 49 (τ -reduction). *Let (σ, Q_s, Q_f, ρ) be a Markov reward chain with fast transitions and let $(\sigma, Q_s, Q_f, \rho) \rightarrow_\infty (\sigma, \Pi, Q, \Pi\rho)$. Assume that $\Pi = RL$ is the canonical product decomposition of Π . Then the τ -reduct of (σ, Q_s, Q_f, ρ) is the Markov reward chain $(\hat{\sigma}, I, \hat{Q}, \hat{\rho})$ defined by*

$$\hat{\sigma} = \sigma R, \quad \hat{Q} = LQ_s R \quad \text{and} \quad \hat{\rho} = L\rho.$$

We give some examples.

Example 50. a. Let (σ, Q_s, Q_f, ρ) be the Markov reward chain with fast transitions from Example 14a. Then

$$L = \begin{pmatrix} 0 & 1 & 0 \\ 0 & 0 & 1 \end{pmatrix} \quad \text{and} \quad R = \begin{pmatrix} 1 & 0 \\ 1 & 0 \\ 0 & 1 \end{pmatrix}.$$

We obtain

$$\hat{\sigma} = (1 \ 0), \quad \hat{Q}_s = \begin{pmatrix} -\mu & \mu \\ 0 & 0 \end{pmatrix} \quad \text{and} \quad \hat{\rho} = \begin{pmatrix} r_2 \\ r_3 \end{pmatrix}.$$

The Markov reward chain $(\hat{\sigma}, \hat{Q}_s, \mathbf{0}, \hat{\rho})$ is depicted in Figure 14a.

- b. Consider now the Markov reward chain with fast transitions from Example 14b. Note that the limit of this Markov reward chain with fast transitions is the discontinuous Markov reward chain from Example 48b when $p = \frac{a}{a+b}$. According to the definition of τ -reduction, both of these processes reduce to the same Markov reward chain. We depict the τ -reduced process in Figure 14b.
- c. As in the previous case, the limit of the Markov reward chain with fast transitions from Example 14c is the discontinuous Markov reward chain from Example 48c for $p = \frac{a}{a+b}$. This automatically gives us the τ -reduced process depicted in Figure 14c.

4.3 τ_{\sim} -reduction and total τ_{\sim} -reduction

In this section we extend the technique of τ -reduction to Markov reward chains with silent transitions. Two methods for reduction are given. The first, called τ_{\sim} -reduction, is a direct lifting of τ -reduction to the set of Markov reward chains with fast transitions. The second method, called total τ_{\sim} -reduction, combines τ -reduction with ordinary lumping for standard Markov reward chains to achieve better aggregation.

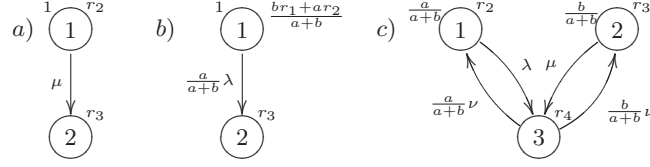

Fig. 14. Markov reward chains obtained by τ -reduction - Example 50

As we did for τ_{\sim} -lumping, we want to define τ_{\sim} -reduction by properly lifting the notion of τ -reduction. Intuitively, we want to say that $(\sigma, Q_s, [Q_f]_{\sim}, \rho)$ can be τ_{\sim} -reduced iff σR , $LQ_s R$ and $L\rho$ do not depend on the choice of the representative $Q_f \in [Q_f]_{\sim}$, where RL is the canonical product decomposition of the ergodic projection of Q_f . As Example 50 shows, not every Markov reward chain with silent transitions is τ -reducible.

We give a definition that characterizes τ_{\sim} -reduction.

Definition 51 (τ_{\sim} -reduction). *Let $(\sigma, Q_s, [Q_f]_{\sim}, \rho)$ be a Markov reward chain with silent transitions and let $\{E_1, E_2, \dots, E_M, T\}$ be its ergodic partitioning. Then $(\sigma, Q_s, [Q_f]_{\sim}, \rho)$ is τ_{\sim} -reducible iff the following conditions hold:*

1. for all $i \in T$, either $\sigma[i] = 0$ or $\text{erg}(i) = E_L$ for some $1 \leq L \leq M$;
2. (a) for all $j \in T$, either $Q_s[i, j] = 0$ for all $1 \leq K \leq M$ and all $i \in E_K$, or $\text{erg}(j) = E_L$ for some $1 \leq L \leq M$; and
 (b) for all $1 \leq K, L \leq M$ and all $i, j \in E_K$,

$$\sum_{\ell: \text{erg}(\ell)=E_L} Q_s[i, \ell] = \sum_{\ell: \text{erg}(\ell)=E_L} Q_s[j, \ell];$$

3. for all $1 \leq K \leq M$ and all $i, j \in E_K$, $\rho[i] = \rho[j]$.

Condition 1 makes sure that an initial transient state can be trapped only in one ergodic class. Allowing it to be trapped in more classes would cause the initial vector of the reduced process to depend on the trapping probabilities (cf. Example 50c). Condition 2a is the same but instead of an initial state we consider a state that has a slow transition leading to it. This is to forbid the situation where, due to the state splitting, the transition rates in the reduced process depend on speeds (see again Example 50c). Note that the reduction aggregates whole ergodic classes and performs weighted summing of all rates that lead out of the states from these classes. The weighted sum is speed independent only if all these rates are equal (otherwise we have the situation as in Example 50b). This is ensured by Condition 2b. Finally, Condition 3 says that states from a same ergodic class must have equal rewards. This is needed because, as for the slow transitions, the new reward is a weighted sum of the rewards from the ergodic class (see Example 50b).

We prove two lemmas that will help us prove that Definition 51 meets all our requirements from the beginning.

Lemma 52. Let $A \in \mathbb{R}^{n \times m}$ be such that $A \geq 0$. Then the following two statements are equivalent:

- μA is the same for any vector $\mu \in \mathbb{R}^{1 \times n}$ such that $\mu > 0$ and $\mu \cdot \mathbf{1} = 1$;
- $A = \mathbf{1} \cdot a$ for some $a \in \mathbb{R}^{1 \times m}$.

Proof. (\Rightarrow) Let μ be such that $\mu > 0$ and $\mu \cdot \mathbf{1} = 1$. Let $k, l \in \{1, \dots, n\}$ be arbitrary and let ε be such that $0 < \varepsilon < \mu_l$. Define $\mu' \in \mathbb{R}^{1 \times n}$ as $\mu'[k] = \mu[k] + \varepsilon$, $\mu'[l] = \mu[l] - \varepsilon$ and $\mu'[i] = \mu[i]$ for $i \neq k, l$. By definition, $\mu' > 0$ and $\mu' \cdot \mathbf{1} = 1$. From $\mu A = \mu' A$ we obtain that, for all $j \in \{1, \dots, m\}$, $\varepsilon A[k, j] - \varepsilon A[l, j] = 0$. Since $\varepsilon > 0$, we have $A[k, j] = A[l, j]$ for all $j \in \{1, \dots, m\}$. Because, k and l were arbitrary, we conclude that all rows in A are equal, i.e. that $A = \mathbf{1} \cdot a$ for some $a \in \mathbb{R}^{1 \times m}$.

(\Leftarrow) Suppose $A = \mathbf{1} \cdot a$ for some $a \in \mathbb{R}^{1 \times m}$. Clearly, $\mu A = \mu \mathbf{1} a = a$ does not depend on μ .

Lemma 53. Let $A \in \mathbb{R}^{m \times n}$ be such that $A \geq 0$. Let $\delta \in \mathbb{R}^{n \times 1}$ be such that $0 \leq \delta \leq \mathbf{1}$. Then the following two statements are equivalent:

- $A\delta = A\delta'$ for all $\delta' \in \mathbb{R}^{n \times 1}$ such that $\delta' \sim \delta$ and $(\delta' - \mathbf{1}) \sim (\delta - \mathbf{1})$;
- for all $1 \leq j \leq n$, either $A[i, j] = 0$ for all $1 \leq i \leq m$, or $\delta[j] \in \{0, 1\}$.

Proof. (\Rightarrow) Let $j \in \{1, \dots, n\}$ be such that $\delta[j] \notin \{0, 1\}$ (if such j does not exist, the theorem follows trivially). Define $\delta' \in \mathbb{R}^{n \times 1}$ by $\delta'[k] = \delta[k]$ for all $k \neq j$, and by $\delta'[j] = \delta[j] + \varepsilon$, for some ε such that $0 < \varepsilon < 1 - \delta[j]$. Clearly, $\delta' \sim \delta$ and $(\delta' - \mathbf{1}) \sim (\delta - \mathbf{1})$ because δ and δ' are different only in one element that is neither zero nor one. Now, from $A\delta = A\delta'$ we obtain that $A[i, j]\delta[j] = A[i, j](\delta[j] + \varepsilon)$ for all $i \in \{1, \dots, m\}$. Since $\varepsilon > 0$, this implies that $A[i, j] = 0$ for all $i \in \{1, \dots, m\}$.

(\Leftarrow) Let $\delta' \in \mathbb{R}^{n \times 1}$ be such that $\delta' \sim \delta$ and $(\delta' - \mathbf{1}) \sim (\delta - \mathbf{1})$. Note that this means that δ and δ' have zeroes and ones on exactly the same positions. Using that $A[i, j] = 0$ whenever $\delta[j] \notin \{0, 1\}$, we have, for any $i \in \{1, \dots, m\}$, that

$$\begin{aligned} (A\delta')[i] &= \sum_{j=1}^n A[i, j]\delta'[j] = \sum_{j:\delta[j]=0,1} A[i, j]\delta'[j] = \\ &= \sum_{j:\delta[j]=0,1} A[i, j]\delta[j] = \sum_{j=1}^n A[i, j]\delta[j] = (A\delta)[i]. \end{aligned}$$

We can now prove that Definition 51 induces exactly the notion that we want.

Theorem 54. Let $(\sigma, Q_s, [Q_f]_{\sim}, \rho)$ be a Markov reward chain with silent transitions. It is τ_{\sim} -reducible iff, for all $Q'_f \sim Q_f$,

$$\sigma R = \sigma R', \quad LQ_s R = L'Q_s R' \quad \text{and} \quad L\rho = L'\rho,$$

where RL and $R'L'$ are canonical product decompositions of the ergodic projections of Q_f and Q'_f respectively.

Proof. The theorem is proven only from right to left but note that every implication step is actually an equivalence step.

Let the numbering be such that it makes the ergodic partitioning explicit. Then

$$\sigma = (\sigma_1 \dots \sigma_M \sigma_T), Q_s = \begin{pmatrix} Q_{11} & \dots & Q_{1M} & X_1 \\ \vdots & \ddots & \vdots & \vdots \\ Q_{M1} & \dots & Q_{MM} & X_M \\ Y_1 & \dots & Y_M & Z \end{pmatrix}, \rho = \begin{pmatrix} \rho_1 \\ \vdots \\ \rho_M \\ \rho_T \end{pmatrix}$$

and

$$L = \begin{pmatrix} \mu_1 & \dots & \mathbf{0} & \mathbf{0} \\ \vdots & \ddots & \vdots & \vdots \\ \mathbf{0} & \dots & \mu_M & \mathbf{0} \end{pmatrix}, R = \begin{pmatrix} \mathbf{1} & \dots & \mathbf{0} \\ \vdots & \ddots & \vdots \\ \mathbf{0} & \dots & \mathbf{1} \\ \delta_1 & \dots & \delta_M \end{pmatrix}.$$

We have $\sigma R = ((\sigma_1 \cdot \mathbf{1} + \sigma_T \cdot \delta_1) \dots (\sigma_M \cdot \mathbf{1} + \sigma_T \cdot \delta_M))$. Let δ'_L be such that $\delta'_L \sim \delta_L$ and $(\delta'_L - \mathbf{1}) \sim (\delta_L - \mathbf{1})$. Let R' be the same as R but with δ'_L instead of δ_L . We can always find a $Q'_f \sim Q_f$ such that $R'L$ is the canonical product decomposition of its ergodic projection. From $\sigma R = \sigma R'$ we obtain $\sigma_T \cdot \delta_L = \sigma_T \cdot \delta'_L$. Now, by Lemma 53 (with $A = \sigma_T$) this can only be if, for all $1 \leq i \leq n$, either $\sigma_T[i] = 0$ or $\delta_L[i] \in \{0, 1\}$ for all $1 \leq L \leq M$. Since $R \cdot \mathbf{1} = \mathbf{1}$, the latter is only possible when there exists an $1 \leq L' \leq M$ such that $\delta_{L'}[i] = 1$. Recall that $\delta_{L'}[i] = 1$ iff $\text{erg}(i) = E_{L'}$.

We have

$$LQ_sR = \begin{pmatrix} \mu_1 Q_{11} \mathbf{1} + \mu_1 X_1 \delta_1 & \dots & \mu_1 Q_{1M} \mathbf{1} + \mu_1 X_1 \delta_M \\ \vdots & \ddots & \vdots \\ \mu_M Q_{M1} \mathbf{1} + \mu_M X_M \delta_M & \dots & \mu_M Q_{MM} \mathbf{1} + \mu_M X_M \delta_M \end{pmatrix}.$$

From $LQ_sR = LQ_sR'$ we obtain $\mu_K X_K \delta_L = \mu_K X_K \delta'_L$. By Lemma 53, the equivalent condition is that for all $1 \leq K \leq M$ and all $1 \leq j \leq n$ either $(\mu_K X_K)[j] = 0$ or $\delta_L[j] \in \{0, 1\}$ for all $1 \leq L \leq M$. Note that, since $\mu_K > 0$, $(\mu_K X_K)[j] = 0$ iff $X_K[i, j] = 0$ for all $i \in E_K$. As before, $\delta_L[j] \in \{0, 1\}$ for all $1 \leq L \leq M$ only if $\delta_{L'}[j] = 1$ for some $1 \leq L' \leq M$.

Let now μ'_K be a stochastic vector such that $\mu'_K \sim \mu_K$. Let L' be formed as L but with μ'_K instead of μ_K . We can always find a $Q'_f \sim Q_f$ such that $R'L'$ is the canonical product decomposition of its ergodic projection. From $LQ_sR = L'Q_sR$ we have $\mu_K(Q_{KL} \mathbf{1} + X_K \delta_L) = \mu'_K(Q_{KL} \mathbf{1} + X_K \delta_L)$. By Lemma 52, it follows that $Q_{KL} \mathbf{1} + X_K \delta_L = \alpha \cdot \mathbf{1}$ for some constant α . In other words, it follows that the rows of $Q_{KL} \mathbf{1} + X_K \delta_L$ are all the same.

From what we proved before, $(X_K \delta_L)[i] = \sum_{\ell: \text{erg}(\ell) = E_L} X_K[i, \ell]$. Thus

$$\sum_{\ell \in E_L} Q_{KL}[i, \ell] + \sum_{\ell \in T: \text{erg}(\ell) = E_L} X_K[i, \ell] = \sum_{\ell \in E_L} Q_{KL}[j, \ell] + \sum_{\ell \in T: \text{erg}(\ell) = E_L} X_K[j, \ell]$$

for all $i, j \in E_K$. Since $\text{erg}(\ell) = E_L$ when $\ell \in E_L$, we have

$$\sum_{\ell: \text{erg}(\ell)=E_L} Q_s[i, \ell] = \sum_{\ell: \text{erg}(\ell)=E_L} Q_s[j, \ell],$$

for all $i, j \in E_K$.

For the reward vector we have $L\rho = \begin{pmatrix} \mu_1 \rho_1 \\ \vdots \\ \mu_M \rho_M \\ \mathbf{0} \end{pmatrix}$. From $L\rho = L'\rho$ we obtain

$\mu_K \cdot \rho_K = \mu'_K \rho_K$. From Lemma 52 it follows that, equivalently, $\rho_K = \mathbf{1} \cdot x_K$ for some row vector x_K . Note that this exactly means that $\rho[i] = \rho[j]$ for all $i, j \in E_K$.

If $(\sigma, Q_s, [Q_f]_{\sim}, \rho)$ is τ_{\sim} -reducible, then we say that it τ_{\sim} -reduces to the Markov reward chain $(\sigma R, I, LQ_s R, \rho R)$, where RL is the canonical product decomposition of the ergodic projection of Q_f . Theorem 54 guarantees that this definition is correct.

We now give some examples of τ_{\sim} -reductions.

- Example 55.* a. Consider the Markov reward chain with silent transitions depicted in Figure 15a. This process can be τ -reduced because its ergodic classes are one-element, and because its only transient state, i.e. state 1, gets trapped only in the state 2. The τ -reduced process is depicted in Figure 16a.
- b. Consider the Markov reward chain with silent transitions depicted in Figure 15b. This process can be τ -reduced because it does not have transient states and because every state in the ergodic class $\{1, 2\}$ does λ to the other ergodic class $\{3\}$. The process τ -reduces to the Markov reward chain depicted in Figure 16b.
- c. Consider the Markov reward chains with silent transitions from Figure 5c and Figure 5d. These Markov reward chains with silent transitions cannot be τ -reduced because they violate the first, resp. the second, condition of Definition 51.

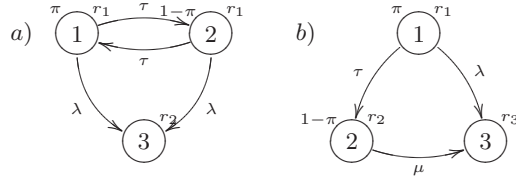

Fig. 15. Markov reward chains with silent transitions that can be τ -reduced – Example 55

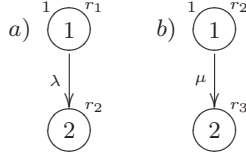

Fig. 16. τ -reduced Markov reward chains with silent transitions from Example 55

Note that the conditions of Definition 51 are very restrictive, and so not many Markov reward chains with silent transitions are τ_{\sim} -reducible. The reason is that in most cases τ -reduction of a Markov reward chain with fast transitions will produce a Markov reward chain in which transitions do depend on the speeds of the fast transitions. The problem with the parameterized slow transitions can however, in some cases, be “repaired” by performing an ordinary lumping on the resulting Markov reward chain. In other words, even if LQ_sR depends on Q_f , it might be the case that its lumped version ULQ_sRV does not. We give an example.

Example 56. Consider the Markov reward chain with silent transitions from Figure 17a. First, we take a representative Markov reward chain with fast transitions such as the one from Figure 17b. Note that this Markov reward chain with silent transitions is τ -reduced to the Markov reward chain in Figure 17c. Observe that this Markov reward chain depends on the parameters a and b . However, the states 1 and 2 can form a lumping class. The resulting Markov reward chain is in Figure 17d. Note that the lumping removed the dependencies on the parameters.

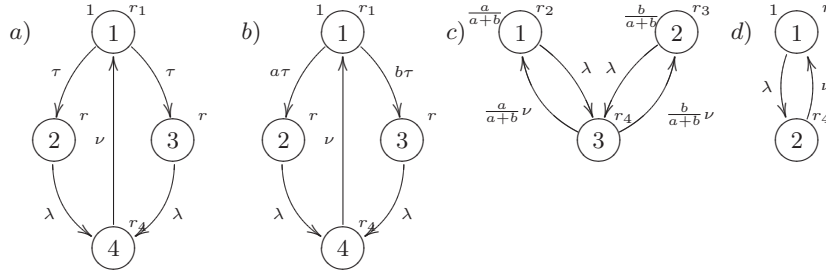

Fig. 17. A total τ_{\sim} reduction – Example 59

We propose a reduction method that combines the reduction and lumping and call it total τ_{\sim} -reduction. In the definition of τ_{\sim} -reduction we need to use the function called flat that gives a set of elements from a set of sets. Formally, if $C \in \mathcal{P}$ and $S \in C$, then $\text{flat}(C) = \bigcup_{S \in C} S$.

Definition 57 (Total τ_{\sim} -reduction). Let $(\sigma, Q_s, [Q_f]_{\sim}, \rho)$ be a Markov reward chain with silent transitions and $\mathcal{E} = \{E_1, \dots, E_M, T\}$ be its ergodic partitioning. Let \mathcal{P} be a partitioning of $\{E_1, \dots, E_M\}$ induced by $V \in \mathbb{R}^{M \times N}$. Then, $(\sigma, Q_s, [Q_f]_{\sim})$ can be total τ_{\sim} -reduced according to \mathcal{P} if:

1. for all $i \in T$, $\sigma[i] = 0$ or $\text{erg}(i) \subseteq \text{flat}(C)$, where $C \in \mathcal{P}$;
2. (a) for all $j \in T$, either $Q_s[i, j] = 0$ for all $i \in \text{flat}(C)$, or $\text{erg}(j) \subseteq \text{flat}(D)$ for some $D \in \mathcal{P}$;
(b) $\sum_{k: \text{erg}(k) \subseteq \text{flat}(D)} Q_s[i, k] = \sum_{k: \text{erg}(k) \subseteq \text{flat}(D)} Q_s[j, k]$, for every $i, j \in \text{flat}(C)$, where $C, D \in \mathcal{P}$ and $C \neq D$; and
3. $\rho[i] = \rho[j]$ for every $i, j \in \text{flat}(C)$.

Note that the conditions for total τ_{\sim} -reduction are very similar to those for τ -reduction. The only difference is that instead of an ergodic class E_L we work with the whole lumping class that contains it (that is why instead of $\text{erg}(i) = E_L$ we have $\text{erg}(i) \subseteq \text{flat}(D)$). We note that in the trivial case when LQ_sR already does not depend on the choice from $[Q_f]_{\sim}$, it is sufficient to use the trivial lumping induced by $V = I$. Then a total τ -reduction degrades to a τ -reduction.

The following theorem gives a characterization of total τ_{\sim} -reduction, i.e. it shows that total τ_{\sim} -reduction meets our requirements.

Theorem 58. Let $(\sigma, Q_s, [Q_f]_{\sim}, \rho)$ be a Markov reward chain with silent transitions, and let $\mathcal{E} = \{E_1, \dots, E_M\}$ be its ergodic partitioning. Let \mathcal{P} be a partitioning of \mathcal{E} . Then $(\sigma, Q_s, [Q_f]_{\sim}, \rho)$ can be totally τ_{\sim} -reduced with respect to \mathcal{P} iff:

1. $VULQ_sRV = LQ_sRV$ and $VUL\rho = L\rho$, for any $Q_f \in [Q_f]_{\sim}$; and
2. $\sigma RV = \sigma R'V$, $ULQ_sRV = UL'Q_sR'V$ and $UL\rho = UL'\rho$ for any $Q_f, Q'_f \in [Q_f]_{\sim}$

where RL and $R'L'$ are canonical product decompositions of the ergodic projections of Q_f and Q'_f respectively, V is the collector for \mathcal{P} and U is a distributor for V .

Proof. Let the numbering be such that first the lumping partitioning $\mathcal{P} = \{C_1, \dots, C_N\}$ is made explicit and then, inside every class also the ergodic partitioning \mathcal{E} is made explicit. This is achieved by first renumbering the ergodic classes as $E_{11}, \dots, E_{1c_1}, \dots, E_{N1}, \dots, E_{Nc_N}$ with $C_k = \{E_{k1}, \dots, E_{kc_k}\}$ for $1 \leq k \leq N$. Then states are renumbered to make the ergodic classes in each lumping class explicit.

We obtain the following forms for σ , Q_s , ρ , U , V , L and R :

$$\sigma = (\sigma_1 \dots \sigma_N \sigma_T), \quad \sigma_K = (\sigma_{K1} \dots \sigma_{Kc_K}),$$

$$Q_s = \begin{pmatrix} Q_{11} & \dots & Q_{1N} & X_1 \\ \vdots & \ddots & \vdots & \vdots \\ Q_{N1} & \dots & Q_{NN} & X_N \\ Y_1 & \dots & Y_N & Z \end{pmatrix}, \quad \rho = \begin{pmatrix} \rho_1 \\ \vdots \\ \rho_N \\ \rho_T \end{pmatrix}, \quad \rho_K = \begin{pmatrix} \rho_{K1} \\ \vdots \\ \rho_{Kc_K} \end{pmatrix},$$

$$L = \begin{pmatrix} \mu_1 & \dots & \mathbf{0} & \mathbf{0} \\ \vdots & \ddots & \vdots & \vdots \\ \mathbf{0} & \dots & \mu_N & \mathbf{0} \end{pmatrix}, R = \begin{pmatrix} R_1 & \dots & \mathbf{0} \\ \vdots & \ddots & \vdots \\ \mathbf{0} & \dots & R_N \\ \delta_1 & \dots & \delta_N \end{pmatrix},$$

$$\mu_K = \begin{pmatrix} \mu_{K1} & \dots & \mathbf{0} \\ \vdots & \ddots & \vdots \\ \mathbf{0} & \dots & \mu_{Kc_K} \end{pmatrix}, R_K = \begin{pmatrix} \mathbf{1} & \dots & \mathbf{0} \\ \vdots & \ddots & \vdots \\ \mathbf{0} & \dots & \mathbf{1} \end{pmatrix}, \delta_K = (\delta_{K1} \dots \delta_{Kc_K}),$$

$$U = \begin{pmatrix} u_1 & \dots & \mathbf{0} \\ \vdots & \ddots & \vdots \\ \mathbf{0} & \dots & u_N \end{pmatrix}, V = \begin{pmatrix} v_1 & \dots & \mathbf{0} \\ \vdots & \ddots & \vdots \\ \mathbf{0} & \dots & v_N \end{pmatrix}, u_K = (u_{11} \dots u_{Kc_K}),$$

$$v_K = \begin{pmatrix} \mathbf{1} \\ \vdots \\ \mathbf{i} \end{pmatrix}.$$

Define

$$\bar{L} = UL = \begin{pmatrix} m_1 & \dots & \mathbf{0} & \mathbf{0} \\ \vdots & \ddots & \vdots & \vdots \\ \mathbf{0} & \dots & m_N & \mathbf{0} \end{pmatrix}, m_K = (u_{K1}\mu_{K1} \dots u_{Kc_K}\mu_{Kc_K})$$

and

$$\bar{R} = RV = \begin{pmatrix} \mathbf{1} & \dots & \mathbf{0} \\ \vdots & \ddots & \vdots \\ \mathbf{0} & \dots & \mathbf{1} \\ d_1 & \dots & d_N \end{pmatrix}, d_K = \delta_K V_K = \sum_{L=1}^{c_K} \delta_{KL}.$$

(\Rightarrow) First, we show that the lumping condition holds. We do this by showing that the the rows of $LQ_s\bar{R}$, resp. $L\rho$, that correspond to the elements of the same class are equal.

It is not hard to show that Condition 2 of Definition 57 implies that, for any $1 \leq K, L \leq N$, all elements of the vector $Q_{KL}\mathbf{1} + X_K d_L$ are equal, i.e. that $Q_{KL}\mathbf{1} + X_K d_L = \mathbf{1} \cdot \alpha_{KL}$ for some $\alpha_{KL} \geq 0$. We obtain

$$LQ_s R' = \begin{pmatrix} \mu_1 \cdot (Q_{11} \cdot \mathbf{1} + X_1 d_1) & \dots & \mu_1 \cdot (Q_{1N} \cdot \mathbf{1} + X_1 d_N) \\ \vdots & \ddots & \vdots \\ \mu_N \cdot (Q_{N1} \cdot \mathbf{1} + X_N d_N) & \dots & \mu_N \cdot (Q_{NN} \cdot \mathbf{1} + X_N d_N) \end{pmatrix}.$$

Now, since $Q_{KL}\mathbf{1} + X_K d_L = \alpha_{KL} \cdot \mathbf{1}$ we have

$$\begin{aligned} \mu_K \cdot (Q_{KL}\mathbf{1} + X_K d_L) &= \mu_K \cdot \alpha_{KL} \cdot \mathbf{1} = \\ &= \alpha_{KL} \begin{pmatrix} \mu_{K1} & \dots & \mathbf{0} \\ \vdots & \ddots & \vdots \\ \mathbf{0} & \dots & \mu_{Kc_K} \end{pmatrix} \cdot \begin{pmatrix} \mathbf{1} \\ \vdots \\ \mathbf{1} \end{pmatrix} = \alpha_{KL} \begin{pmatrix} \mu_{K1}\mathbf{1} \\ \vdots \\ \mu_{Kc_K}\mathbf{1} \end{pmatrix} = \alpha_{KL} \cdot \mathbf{1}. \end{aligned}$$

From Condition 3 we obtain that $\rho_K = \alpha_K \cdot \mathbf{1}$ for some constant α_K . We also have

$$L\rho = \begin{pmatrix} \mu_1\rho_1 \\ \vdots \\ \mu_N\rho_N \\ \mathbf{0} \end{pmatrix}.$$

Now, since $\rho_K = \mathbf{1} \cdot \alpha_K$, with the same calculation as before, we obtain $\mu_K\rho_K = \alpha_K \cdot \mathbf{1}$. We conclude that the lumping condition holds.

Now suppose that \bar{R}' is defined in the similar way as \bar{R} . From $\sigma_T\delta_K = \sum_{i:d_K[i]=1} \sigma[i] = \sum_{i:d'_K[i]=1} \sigma[i]$ it easily follows that $\sigma\bar{R}' = \sigma\bar{R}$. That $L'Q_s\bar{R}' = LQ_s\bar{R}$ follows from $X_Kd_L = X_Kd'_L$ and $\mu_K \cdot (Q_{KL}\mathbf{1} + X_Kd_L) = \alpha_{KL} \cdot \mathbf{1}$, both implied by Condition 2. Finally, that $L'\rho = L\rho$ follows from $\mu_K\rho_K = \alpha_K \cdot \mathbf{1} = \mu'_K\rho_K$.

(\Leftarrow) Because of the lumping condition we can assume that $u_K > 0$ for all $1 \leq K \leq N$. Observe that the form of \bar{L} and \bar{R} is very similar to the form of L and R . Let $K \in \{1, \dots, N\}$. Since $u_K > 0$, we have $m_K > 0$. Also, since the elements of μ_K range over all positive numbers, also the m_K elements of m_K ranges over all positive numbers. Clearly, $0 \leq d_K \leq \mathbf{1}$ and since the elements of δ_K that are not in $\{0, 1\}$ can take any value in $(0, 1)$, the same holds for the elements of d_K . This allows us to proceed just as we did in the proof of Theorem 54 but with the matrices \bar{L} and \bar{R} instead of L and R .

First, we have that for all $1 \leq i \leq n$, either $\sigma_T[i] = 0$ or there is a $K \in \{1, \dots, N\}$ such that $d_K[i] = 1$. Now, note that $d_K[i] = \sum_{L=1}^{c_K} \delta_{KL}$ is equal to 1 only if $\text{erg}(i) \subseteq (E_{K_1} \cup \dots \cup E_{K_{c_K}}) = \text{flat}(C_K)$. This gives us Condition 1.

Second, we have that a) for all $1 \leq j \leq n$, either $X_K[i, j] = 0$ for all $i \in C_K$, or $d_L[j] = 1$ for some $1 \leq L \leq N$, and b) the rows of $Q_{KL}\mathbf{1} + X_Kd_L$ are all the same, i.e. $(Q_{KL}\mathbf{1} + X_Kd_L)[i] = (Q_{KL}\mathbf{1} + X_Kd_L)[j]$ for all i, j . Then

$$(Q_{KL}\mathbf{1})[i] + (X_Kd_L)[i] = \sum_{\ell \in C_L} Q_{KL}[i, \ell] + \sum_{\substack{\ell : \ell \in T \\ \text{erg}(\ell) = \text{flat}(C_L)}} Q_s[i, \ell] = \sum_{\ell : \text{erg}(\ell) = \text{flat}(C_L)} Q_s[i, \ell].$$

Finally, for the reward vector, we have $\rho_K = \alpha_K \cdot \mathbf{1}$ for some constant α_K . Note that this exactly means that $\rho[i] = \rho[j]$ for all $i, j \in \text{flat}(C_K)$.

If a Markov reward chain with silent transitions can be totally τ_{\sim} -reduced with respect to a partitioning \mathcal{P} , we say that it totally τ_{\sim} -reduces to $(\sigma RV, I, ULQ_s RV, UL\rho)$, where RL is the canonical product decomposition of the ergodic projection of Q_f , V is the collector for \mathcal{P} , and U is a distributor for V .

We give an example.

Example 59. Consider the Markov reward chain with silent transitions from Figure 17a. Its ergodic partitioning is $\mathcal{E} = \{E_1, E_2, E_3, T\}$ where $E_1 = \{2\}$, $E_2 = \{3\}$ and $E_3 = \{4\}$. Define $\mathcal{P} = \{C_1, C_2\}$ where $C_1 = \{2, 3\}$ and $C_2 = \{4\}$. It is not hard to see that the conditions for total τ_{\sim} -reducibility hold. The process totally τ_{\sim} -reduces to the Markov reward chain depicted in Figure 17d.

5 Comparative Analysis

In this section we compare the lumping method with the reduction method. We show that they are in general incomparable but that reduction combined with standard lumping (on the resulting Markov reward chain) gives in general better results. The main result of the section is that the notion of τ_{\sim} -lumping coincides with the notion of total τ -reduction (in a non-degenerate case). At the end, we also show how τ_{\sim} -lumping (and, hence, total τ -reduction too) compares with weak bisimulation for Interactive Markov chains from [4].

5.1 Reduction vs. Lumping

In general, the reduction of a discontinuous Markov reward chain to a Markov reward chain and the ordinary lumping are incomparable. However, when reduction is combined with the standard ordinary lumping for Markov reward chains it becomes a superior method. We give an example.

Example 60. Recall, from Example 48c, that the discontinuous Markov reward chain (σ, Π, Q, ρ) defined by

$$\sigma = (1 \ 0 \ 0 \ 0), \quad \Pi = \begin{pmatrix} 0 & p & 1-p & 0 \\ 0 & 1 & 0 & 0 \\ 0 & 0 & 1 & 0 \\ 0 & 0 & 0 & 1 \end{pmatrix},$$

$$Q = \begin{pmatrix} 0 & -p\lambda & -(1-p)\mu & p\lambda + (1-p)\mu \\ 0 & -\lambda & 0 & \lambda \\ 0 & 0 & -\mu & \mu \\ \nu & 0 & 0 & -\nu \end{pmatrix} \quad \text{and} \quad \rho = \begin{pmatrix} r_1 \\ r_2 \\ r_3 \\ r_4 \end{pmatrix}.$$

was reduced to the Markov reward chain (σ, I, Q, ρ) defined by

$$\hat{\sigma} = (p \ 1-p \ 0), \quad \hat{Q} = \begin{pmatrix} -\lambda & 0 & \lambda \\ 0 & -\mu & \mu \\ p\nu & (1-p)\nu & -\nu \end{pmatrix} \quad \text{and} \quad \hat{\rho} = \begin{pmatrix} r_2 \\ r_3 \\ r_4 \end{pmatrix}.$$

Note however that, if $\lambda \neq \mu$, the process (σ, Π, Q, ρ) only has the trivial lumping (cf. Example 25) and so, in this case, reduction performs better.

Ordinary lumping sometimes aggregates more than reduction. This is because lumping classes can contain states from different ergodic classes while reduction only aggregates whole ergodic classes and transient states. Lumping also gives more flexibility in the sense that one can obtain the (intermediate) lumped processes that are not necessarily Markov reward chains. Consider again the same discontinuous Markov reward chain (σ, Π, Q, ρ) but with $\lambda = \mu$. In Example 25 we showed that this process could be lumped to the discontinuous Markov reward chain

$$\check{\sigma} = (1 \ 0 \ 0), \quad \check{\Pi} = \begin{pmatrix} 0 & 1 & 0 \\ 0 & 1 & 0 \\ 0 & 0 & 1 \end{pmatrix}, \quad \check{Q} = \begin{pmatrix} 0 & -\lambda & \lambda \\ 0 & -\lambda & \lambda \\ \nu & 0 & -\nu \end{pmatrix} \quad \text{and} \quad \check{\rho} = \begin{pmatrix} r_1 \\ r \\ r_4 \end{pmatrix},$$

or all the way to the Markov reward chain

$$\check{\sigma} = (1 \ 0), \quad \check{H} = I, \quad \check{Q} = \begin{pmatrix} -\lambda & \lambda \\ \nu & -\nu \end{pmatrix}, \quad \text{and} \quad \check{\rho} = \begin{pmatrix} r \\ r_4 \end{pmatrix}$$

These two processes cannot be obtained by reduction.

Note that, although the last process in the previous example cannot be directly obtained by reduction, it can be obtained from the reduced process $(\hat{\sigma}, \hat{H}, \hat{Q}, \hat{\rho})$ by the lumping $\{\{1, 2\}, \{3\}\}$. Based on this we find it interesting to compare the ordinary lumping method for discontinuous Markov reward chains with the combination of the reduction method and the standard lumping for Markov reward chains. The following theorem shows that reducing a discontinuous Markov reward chain to a Markov reward chain first, and then lumping it, produces, in general, better results than only doing the lumping from the start.

Theorem 61. *Suppose $(\sigma, H, Q, \rho) \rightarrow_{\mathcal{P}} (\hat{\sigma}, \hat{H}, \hat{Q}, \hat{\rho})$. If $\hat{H} = I$, then there exists a collector matrix V_E such that*

$$V_E U_E L Q R V_E = L Q R V_E, \quad V_E U_E L \rho = L \rho,$$

$$\hat{\sigma} = \sigma R V_E, \quad \hat{Q} = U_E L Q R V_E \quad \text{and} \quad \hat{\rho} = U_E L \rho,$$

where $RL = H$ is the canonical product decomposition of H , and U_E is a distributor associated to V_E .

Proof. Let V be the collector associated to \mathcal{P} and let U be its associated distributor. From $UHV = I$, multiplying by V from the left and using that $VUHV = HV$, we obtain $HV = V$. Define $V_E = LV$ and $U_E = UR$. First we show that V_E is a collector matrix.

That U_E is a distributor associated to V_E follows from $U \geq 0$, $R \geq 0$ and $U_E V_E = U R L V = U H V = I$. Now, using that $HQ = QH = Q$ and that $VUQV = QV$, we have

$$\begin{aligned} V_E U_E L Q R V_E &= LVURLQRLV = LVUHQHV = \\ &= LVUQV = LQV = LHQHV = LQRLV = LQ R V_E. \end{aligned}$$

Similarly, using that $VU\rho = \rho$, we have

$$V_E U_E L \rho = LVURL\rho = LVUH\rho = LVUHVU\rho = LHVU\rho = LH\rho = L\rho.$$

In addition, $\sigma R V_E = \sigma R L V = \sigma H V = \sigma V = \hat{\sigma}$,

$$U_E L Q R V_E = U R L Q R L V = U H Q H V = U Q V = \hat{Q}$$

and

$$U_E L \rho = U R L \rho = U H \rho U H V U \rho = U V U \rho = U \rho = \hat{\rho}.$$

We can also see when a reduction and a lumping coincide. Clearly, this is only when $LV = I$ and $UR = I$. The first equality implies that lumping is performed such that each ergodic class is one partitioning class. The second equality implies that there are no transient states that are trapped to more than one ergodic class in the original process. This was the case for the discontinuous Markov reward chain from Example 10b, that was lumped (Example 25b) and reduced (Example 48b) to the same Markov reward chain.

5.2 τ -reduction vs. τ -lumping

As τ -reduction and τ -lumping are based on the reduction method and ordinary lumping respectively, it comes as no surprise that the two methods are again incomparable. Moreover, as expected, τ -reduction combined with ordinary lumping aggregates more than just τ -lumping.

We give an example that corresponds to Example 60.

Example 62. Consider the Markov reward chain with fast transitions depicted in Figure 18a. Example 48c shows that this Markov reward chain with fast transitions reduced to the Markov reward chain from Figure 18b. This aggregation cannot be obtained by lumping. On the other hand, if $\lambda = \mu$, the process from Figure 18a τ -lumps to the Markov reward chain in Figure 18c by the lumping $\{\{1\}, \{2, 3\}, \{4\}\}$, and to the one Figure 18d by the lumping $\{\{1, 2, 3\}, \{4\}\}$. These aggregations cannot be obtained by reduction. However, when $\lambda = \mu$, the Markov reward chain from Figure 18b lumps by the standard lumping to the Markov reward chain in Figure 18d. Therefore, like in the case for reduction, although the aggregation methods are incomparable, τ -reduction combined with standard lumping is more superior than just τ -lumping.

Theorem 63. *Suppose $(\sigma, Q_s, Q_f, \rho) \rightarrow_{\mathcal{P}} (\hat{\sigma}, \hat{Q}_s, \hat{Q}_f, \hat{\rho})$. If $\hat{Q}_f = \mathbf{0}$, then there exists a collector matrix V_E such that*

$$V_E U_E L Q_s R V_E = L Q_s R V_E, \quad V_E U_E L \rho = L \rho,$$

$$\hat{\sigma} = \sigma R V_E, \quad \hat{Q}_s = U_E L Q_s R V_E \text{ and } \hat{\rho} = U_E L \rho,$$

where $RL = \Pi$ is the canonical product decomposition of Π , the ergodic projection of Q_f , and U_E is a distributor associated to V_E .

Proof. Since $\hat{Q}_f = \mathbf{0}$, by Theorem 39, we obtain $\hat{\Pi} = I$. As in the proof of Theorem 40, this implies $\Pi V = V$ and $W \Pi = W$. Let $V_E = LV$ and $U_E = WR$. That V_E is a collector matrix and that U_E is a distributor associated to it is shown in the proof of Theorem 61.

Now, using that $VW \Pi Q_s \Pi V = \Pi Q_s \Pi V$, we have

$$\begin{aligned} V_E U_E L Q_s R V_E &= LVWRLQ_sRLV = \\ &= LVW \Pi Q_s \Pi V = L \Pi Q_s \Pi V = L Q_s RLV = L Q_s R V_E. \end{aligned}$$

Similarly, using that $VW\Pi\rho = \Pi\rho$, we have

$$V_E U_E L\rho = LVWRL\rho = LVW\Pi\rho = L\Pi\rho = L\rho.$$

In addition, $\sigma R V_E = \sigma R L V = \sigma \Pi V = \sigma V = \hat{\sigma}$,

$$U_E L Q_s R V_E = W R L Q_s R L V = W \Pi Q_s \Pi V = W Q V = \hat{Q}_s$$

and

$$U_E L\rho = W R L\rho = W \Pi\rho = W\rho = \hat{\rho}.$$

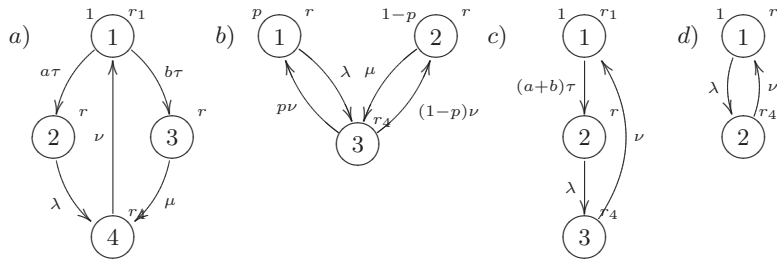

Fig. 18. τ -reduction vs. τ -lumping –Example 62

Both techniques produce the same simplified process only in the case where no transient states are trapped to more than one ergodic class and in that case τ -lumping is performed such that each ergodic class is one lumping class. The Markov reward chain with fast transitions from Figure 19a reduces (Example 48b) and lumps (Example 32b) to the same Markov reward chain in Figure 19b.

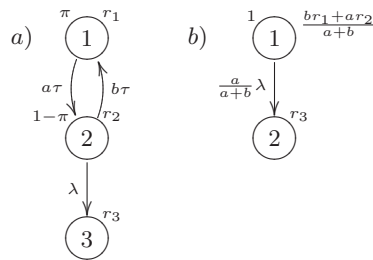

Fig. 19. τ -reduction sometimes coincides with τ lumping

5.3 τ_{\sim} -reduction vs. τ_{\sim} -lumping

In this section we compare τ_{\sim} -lumping with τ_{\sim} - and total τ_{\sim} -reduction. We show that τ_{\sim} -reduction is just a special instance of τ_{\sim} -lumping, and that τ_{\sim} -lumping and total τ_{\sim} -reduction coincide when lumping eliminates all silent transitions.

The following example shows that τ_{\sim} -lumping aggregates more than τ_{\sim} -reduction.

Example 64. Consider the Markov reward chain with silent transitions depicted in Figure 20a. This process τ_{\sim} -lumps to the Markov reward chain in Figure 20b by the lumping $\{\{1, 2, 3\}, \{4\}\}$. However, the process in Figure 20a cannot be τ_{\sim} -reduced because the state 1 violates the condition that a transient state must lead to exactly one ergodic class.

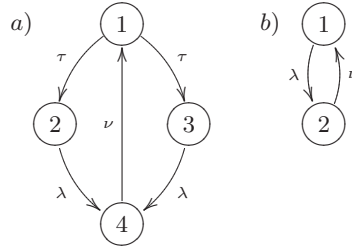

Fig. 20. A process in a) τ_{\sim} -lumps to the one in b) but cannot be τ_{\sim} -reduced – Example 64

We now prove that τ_{\sim} -reduction is a special case of τ_{\sim} -lumping in case the process does not have unreachable states.

Definition 65. A state i is a reachable state if there exists j_0, \dots, j_m such that $\sigma[j_0] \neq 0$, $j_m = i$, and, for all $0 \leq k \leq m$, either $Q_s[j_k, j_{k+1}] > 0$ or $Q_f[j_k, j_{k+1}] > 0$.

Theorem 66. Suppose $(\sigma, Q_s, [Q_f]_{\sim}, \rho)$ τ_{\sim} -reduces to $(\sigma R, I, LQ_s R, L\rho)$. If $(\sigma, Q_s, [Q_f]_{\sim}, \rho)$ does not contain unreachable states, then there exists a partitioning \mathcal{P} such that $(\sigma, Q_s, [Q_f]_{\sim}, \rho) \xrightarrow{\mathcal{P}}_{\tau_{\sim}} (\sigma V, WQ_s V, \{\mathbf{0}\}, W\rho)$, where V is the collector associated to \mathcal{P} and W is a τ -distributor associated with Q_f . Moreover, $V = R$ and $W = L$.

Proof. Let $\mathcal{E} = \{E_1, \dots, E_S, T\}$ be the ergodic partitioning of the Markov reward chain with silent transitions $(\sigma, Q_s, [Q_f]_{\sim}, \rho)$. We first show that for all $t \in T$ there is a $I \in \{1, \dots, S\}$ such that $\text{erg}(t) = E_I$.

Since $(\sigma, Q_s, [Q_f]_{\sim}, \rho)$ does not have unreachable states, we have that there exist i_0, \dots, i_m such that $\sigma[i_0] \neq 0$, $i_m = t$, and, for all $0 \leq k \leq m$, either

$Q_s[i_k, i_{k+1}] > 0$ or $Q_f[i_k, i_{k+1}] > 0$. We prove by induction on m that $\text{erg}(t) = E_I$ for some $I \in \{1, \dots, S\}$.

If $m = 0$, then $\sigma[i_0] \neq 0$ and the statement follows from the first condition in Theorem 54. Suppose the statement holds for all $k \leq m$. Now, if $Q_f[i_k, i_{k+1}] > 0$ then, because $t = i_{m+1} \in T$ also $i_m \in T$. By the inductive hypothesis $\text{erg}(i_m) = E_L$ for some $L \in \{1, \dots, S\}$. Since $\text{erg}(i_{m+1}) \subseteq \text{erg}(i_m)$, we have $\text{erg}(i_{m+1}) \subseteq E_L$ and so $\text{erg}(i_{m+1}) = E_L$. If $Q_s[i_k, i_{k+1}] > 0$, then the statement follows by Condition 2a of Theorem 54.

We now construct the lumping partitioning. Define now $F_I = E_I \cup \{t \mid t \in T, \text{erg}(t) = E_I\}$, for $1 \leq I \leq S$ and let $\mathcal{P} = \{F_1, \dots, F_S\}$. Since $\text{erg}(F_I) = E_I$ and $F_I = \{i \mid \text{erg}(i) = E_I\}$, by Theorem 54 it follows that \mathcal{P} satisfies the conditions of Definition 42.

To show that the τ_{\sim} -lumped and the τ_{\sim} -reduced process coincide, we recall the proof of Theorem 54 where it was shown that R is always a collector matrix. We also note that L is a τ -distributor because $LR = I$ and because, for $\Pi = RL$, it satisfies $\Pi R L \Pi = \Pi \Pi \Pi = \Pi \Pi = \Pi R L$.

We now compare τ_{\sim} lumping with total τ_{\sim} reduction. The following two theorems show that the notions coincide.

Theorem 67. *Suppose $(\sigma, Q_s, [Q_f]_{\sim}, \rho) \rightarrow_{\mathcal{P}} (\hat{\sigma}, \hat{Q}_s, \{\mathbf{0}\}, \hat{\rho})$. and suppose \mathcal{E} is the ergodic partitioning of $(\sigma, Q_s, [Q_f]_{\sim}, \rho)$. Then there exists a partitioning $\mathcal{P}_{\mathcal{E}}$ of \mathcal{E} such that $(\sigma, Q_s, [Q_f]_{\sim}, \rho)$ totally τ_{\sim} -reduces to $(\hat{\sigma}, I, \hat{Q}_s, \hat{\rho})$.*

Proof. Since $[\hat{Q}_f]_{\sim} = \{\mathbf{0}\}$, we have that for every $C \in \mathcal{P}$ and every $i \in C$, $\text{erg}(i) \subseteq C$. This implies that if $i \in C \cap E$, for some $E \in \mathcal{E}$, then $E \subseteq C$. Intuitively, every lumping class must contain whole ergodic classes. Define, for each $C \in \mathcal{P}$, $e(C) = \{E \mid E \subseteq C\}$ and define $\mathcal{P}_{\mathcal{E}} = \{e(C) \mid C \in \mathcal{P}\}$. Clearly, $\mathcal{P}_{\mathcal{E}}$ is a partitioning of \mathcal{E} . Observe that $\text{flat}(e(C)) = \bigcup_{E \subseteq C} E = C \cap \bigcup_{k=1}^M E_k$ for $\mathcal{E} = \{E_1, \dots, E_M\}$. With this, the conditions of Definition 42 directly imply the conditions of Definition 58.

To show that the results of the lumping and the reduction are the same let V and $V_{\mathcal{E}}$ be the collectors associated to \mathcal{P} and $\mathcal{P}_{\mathcal{E}}$ respectively. We choose a Q_f and obtain Π, L, R and W . Since $i \in C \cap E$ implies $E \in \mathcal{E}$, it follows easily that $V_{\mathcal{E}} = LV$. From $\hat{Q}_f = WQ_fV = \mathbf{0}$ it follows, as before, that $\Pi V = V$ and that $\Pi \Pi = W$. Define $U_{\mathcal{E}} = WR \geq 0$. Now $U_{\mathcal{E}}V_{\mathcal{E}} = WRLV = \Pi V = V$ and so $U_{\mathcal{E}}$ is a distributor for $V_{\mathcal{E}}$. Finally, $U_{\mathcal{E}}L = WRL = \Pi \Pi = W$ and $RV_{\mathcal{E}} = RLV = \Pi V = V$, which clearly completes the proof.

Theorem 68. *Let $(\sigma, Q_s, [Q_f]_{\sim}, \rho)$ be a Markov reward chain with silent transitions that does not have unreachable states. Let \mathcal{E} be its ergodic partitioning and let $\mathcal{P}_{\mathcal{E}}$ be some partitioning of \mathcal{E} . If $(\sigma, Q_s, [Q_f]_{\sim}, \rho)$ totally τ_{\sim} -reduces with respect to $\mathcal{P}_{\mathcal{E}}$ to $(\hat{\sigma}, I, \hat{Q}_s, \hat{\rho})$, then there is a partitioning of states \mathcal{P} such that $(\sigma, Q_s, [Q_f]_{\sim}, \rho)$ τ_{\sim} -lumps to $(\hat{\sigma}, \hat{Q}_s, \{\mathbf{0}\}, \hat{\rho})$ with respect to \mathcal{P} .*

Proof. In the same way as we did in the proof of Theorem 66, we can show that, for all $t \in T$ there is a $C \in \mathcal{P}$ such that $\text{erg}(t) = \text{flat}(C)$.

Let \mathcal{E} is the ergodic partitioning of $(\sigma, Q_s, [Q_f]_{\sim}, \rho)$. Define, for each $C \in \mathcal{P}$, $s(C) = \{i \mid \text{erg}(i) \subseteq \text{flat}(C)\}$. Define also $\mathcal{P} = \{s(C) \mid C \in \mathcal{P}_{\mathcal{E}}\}$. We show that \mathcal{P} is a τ_{\sim} -lumping.

Let $i \in s(C)$. Then $\text{erg}(i) \subseteq \text{flat}(C)$ and so $\text{erg}(s(C)) \subseteq \text{flat}(C) \subseteq s(C)$. This proves Condition 1a of 42. The other two conditions follow directly from $s(C) \cap \text{flat}(\mathcal{E}) = \text{flat}(C)$.

We now show that the aggregated chains are the same.

We fix Q_f and obtain Π , L and R . Let $V_{\mathcal{E}}$ be the collector associated to $\mathcal{P}_{\mathcal{E}}$. Define $V = RV_{\mathcal{E}}$. From the definition of \mathcal{P} it follows directly that V is the collector for \mathcal{P} . Let $U_{\mathcal{E}}$ be a distributor for V such that $V_{\mathcal{E}}[i, k] = 1$ implies $U_{\mathcal{E}}[j, i] > 0$. Define $W = U_{\mathcal{E}}L$. That W is a τ -distributor from Definition 30 follows from $W\Pi = U_{\mathcal{E}}LRL = U_{\mathcal{E}}L = W$.

5.4 τ_{\sim} -lumping vs. Weak bisimulation for Interactive Markov Chains

We have already mentioned the aggregation method for the elimination of vanishing markings in generalized stochastic Petri nets is a special instance of τ -reduction. In this section we compare the τ_{\sim} -lumping method with the weak bisimulation method for the elimination of τ transitions in Interactive Markov Chains. We assume that there are no other actions but τ actions in an Interactive Markov Chain (note that weak bisimulation works in the other case as well). We also assume that there are no rewards associated to states. We do not allow silent transitions to lead from a state to itself. However, as we treat them as exponential rates, they are redundant anyway. We give priority to silent transitions over exponential delays only in transient states (see Example 45a) and not in ergodic states (see Example 41a). This leads to a different treatment of τ -divergence. For us, an infinite avoidance of an exponential delay is not possible. The transition must eventually be taken after an exponential delay (see Example 45b). This can be considered as some kind of fairness incorporated in the model. Due to the strong requirement that the lumping of Markov reward chains with silent transitions is good if it is good for all possible speeds assigned to silent transitions, τ_{\sim} -lumping does not always allow for joining states that lead to different ergodic classes (see Example 41b) unless these ergodic classes are also inside some lumping class. This means that we only disallow certain intermediate lumping steps while weak bisimulation does not. In all other cases, the weak bisimilarity of Interactive Markov Chains and τ_{\sim} -lumping coincide.

5.5 Conclusion

We compared two different aggregation techniques, one based on reduction and the other based on lumping, for elimination of fast transitions and silent steps in extensions of continuous-time Markov reward chains. We treated fast transitions and silent steps as exponentially distributed delays of which the rates tend to infinity with determined and undetermined speeds, respectively. We showed that the techniques, in general, rarely produce Markov reward chains of comparable

form in the case of fast transitions. The τ -reduction method always removes all fast transitions, whereas the approach based on τ -lumping is not always able to eliminate the fast transitions. The advantage of *tau*-reduction is in its ability to split transient states. Moreover, the combination of τ -reduction and ordinary lumping proves to be superior in the ability to reduce a given Markov reward chain with fast transitions. The analysis suggests that the combination of τ -reduction and ordinary lumping can be successfully used handle probabilistic choices in Markov reward chain-based extensions. In case the τ -lumping can be performed such that all fast transitions are eliminated, the simplified processes obtained from both methods have the same abstracted performance characteristics.

We have extended the method of [18, 19] in the setting of silent steps. We have shown that both aggregation techniques produce the same simplified processes when all silent steps can be eliminated. However, in the setting with silent steps, the τ_{\sim} -lumping provides more flexibility in the sense that it is not mandatory to eliminate all silent steps at once, so all intermediate processes can be obtained [30]. We note that the results from this paper can be used to extend the aggregation method that is used to eliminate vanishing markings in generalized stochastic Petri nets, by dropping the requirement that the probabilities of the immediate transitions must be stated explicitly. Thus, our approach can provide an inherent method for elimination of the vanishing markings in the case when the weights of the immediate transitions are left unspecified.

References

1. Doob, J.: Stochastic Processes. Wiley (1953)
2. Chung, K.: Markov Chains with Stationary Probabilities. Springer (1967)
3. Howard, R.: Semi-Markov and Decision Processes. Wiley (1971)
4. Hermanns, H.: Interactive Markov Chains: The Quest for Quantified Quality. Volume 2428 of LNCS. Springer (2002)
5. Hillston, J.: A Compositional Approach to Performance Modelling. Cambridge University Press (1996)
6. Marsan, M., Conte, G., Balbo, G.: A class of generalized stochastic Petri nets for the performance evaluation of multiprocessor systems. ACM Transactions on Computer Systems **2** (1984) 93–122
7. Marsan, M., Balbo, G., Conte, G., Donatelli, S., Franceschinis, G.: Modelling with Generalized Stochastic Petri Nets. Wiley (1995)
8. Grassmann, W., Wang, Y.: Immediate events in Markov chains. In: Computations with Markov chains, Kluwer (1995) 163–176
9. Wu, S.H., Smolka, S., Stark, E.: Composition and behaviors of probabilistic I/O automata. Theoretical Computer Science **176**(1–2) (1997) 1–38
10. Plateau, B., Atif, K.: Stochastic automata network of modeling parallel systems. IEEE Transactions on Software Engineering **17**(10) (1991) 1093–1108
11. Milner, R.: Operational and algebraic semantics of concurrent processes. In: Handbook of Theoretical Computer Science, Volume B: Formal Models and Semantics (B). MIT Press (1990) 1201–1242
12. Kemeny, J., Snell, J.: Finite Markov chains. Springer (1976)

13. Nicola, V.: Lumping in Markov reward processes. IBM Research Report RC 14719, IBM (1989)
14. Buchholz, P.: Exact and ordinary lumpability in finite Markov chains. *Journal of Applied Probability* **31** (1994) 59–75
15. Ciardo, G., Muppala, J., Trivedi, K.: On the solution of GSPN reward models. *Performance Evaluation* **12** (1991) 237–253
16. Ammar, H., Huang, Y., Liu, R.: Hierarchical models for systems reliability, maintainability, and availability. *IEEE Transactions on Circuits and Systems* **34**(6) (1987) 629–638
17. Doeblin, W.: Sur l'équation matricielle $A(t+s) = A(t)A(s)$ et ses applications aux probabilités en chaîne. *Bull. Sci. Math.* **62** (1938) 21–32
18. Delebecque, F., Quadrat, J.: Optimal control of Markov chains admitting strong and weak interactions. *Automatica* **17** (1981) 281–296
19. Coderch, M., Willsky, A., Sastry, S., Castanon, D.: Hierarchical aggregation of singularly perturbed finite state Markov processes. *Stochastics* **8** (1983) 259–289
20. Cerotti, D., Donatelli, S., Horvath, A., Sproston, J.: CSL model checking for generalized stochastic Petri nets. In: *Third International Conference of Quantitative Evaluation of Systems*, IEEE Computer Society (2006) 199–210
21. Delebecque, F.: A reduction process for perturbed Markov chains. *SIAM Journal of Applied Mathematics* **2** (1983) 325–330
22. Markovski, J., Trčka, N.: Lumping Markov chains with silent steps. Technical Report CS 06/13, Technische Universiteit Eindhoven (2006)
23. Hille, E., Phillips, R.: *Functional Analysis and Semi-Groups*. AMS (1957)
24. Campbell, S.: *Singular Systems of Differential Equations I*. Pitman (1980)
25. Koliha, J., Tran, T.: Semistable operators and singularly perturbed differential equations. *Journal of Mathematical Analysis and Applications* **231** (1999) 446–458
26. Agaev, R., Chebotarev, P.: On determining the eigenprojection and components of a matrix. *Automated Remote Control* **63** (2002) 1537–1545
27. Segala, R., Lynch, N.: Probabilistic simulations for probabilistic processes. *Nordic J. of Computing* **2**(2) (1995) 250–273
28. Hartfiel, D.: *Markov Set-Chains*. Springer-Verlag (1998)
29. Farid, F.: Criteria for invertibility of diagonally dominant matrices. *Linear Algebra Appl.* **215** (1995) 63–93
30. Markovski, J., Trčka, N.: Lumping Markov chains with silent steps. In: *Third International Conference of Quantitative Evaluation of Systems*, IEEE Computer Society (2006) 221–230