

IP-recovery in the DVB-H link layer for TV on mobile

Citation for published version (APA):

Eerenberg, O., Koppelaar, A. G. C., Stuivenwold, A., & With, de, P. H. N. (2011). IP-recovery in the DVB-H link layer for TV on mobile. *IEEE Transactions on Consumer Electronics*, 57(2), 339-347.
<https://doi.org/10.1109/TCE.2011.5955165>

DOI:

[10.1109/TCE.2011.5955165](https://doi.org/10.1109/TCE.2011.5955165)

Document status and date:

Published: 01/01/2011

Document Version:

Publisher's PDF, also known as Version of Record (includes final page, issue and volume numbers)

Please check the document version of this publication:

- A submitted manuscript is the version of the article upon submission and before peer-review. There can be important differences between the submitted version and the official published version of record. People interested in the research are advised to contact the author for the final version of the publication, or visit the DOI to the publisher's website.
- The final author version and the galley proof are versions of the publication after peer review.
- The final published version features the final layout of the paper including the volume, issue and page numbers.

[Link to publication](#)

General rights

Copyright and moral rights for the publications made accessible in the public portal are retained by the authors and/or other copyright owners and it is a condition of accessing publications that users recognise and abide by the legal requirements associated with these rights.

- Users may download and print one copy of any publication from the public portal for the purpose of private study or research.
- You may not further distribute the material or use it for any profit-making activity or commercial gain
- You may freely distribute the URL identifying the publication in the public portal.

If the publication is distributed under the terms of Article 25fa of the Dutch Copyright Act, indicated by the "Taverne" license above, please follow below link for the End User Agreement:

www.tue.nl/taverne

Take down policy

If you believe that this document breaches copyright please contact us at:

openaccess@tue.nl

providing details and we will investigate your claim.

IP-Recovery in the DVB-H Link Layer for TV on Mobile

Onno Eerenberg, Arie Koppelaar, Armand M. Stuivenwold and Peter H. N. de With

Abstract — Recently, DVB-H Internet Protocol based TV on Mobile devices made its entrance in the mobile arena. Due to transmission over an error-prone channel, IP datagrams (packet at network layer) may be corrupted. To improve reception robustness, the DVB-H link layer is equipped with Forward Error Correction (FEC), allowing correction of erroneous IP datagrams, using two-bit signaling information. During reception, locator information is derived prior to FEC, indicating the storage position of correctly received IP datagrams. This is essential due to the variable-length sizes of the IP-based data. For the situation that FEC fails to correct all erroneously received data, the locator information enables retrieval of all correctly received IP datagrams and indicates the location of potentially corrected IP datagrams. Using the derived locator information, experimental research has shown that after FEC, a considerable number of correct IP datagrams can still be recovered from an incorrect MPE-FEC frame. This results in up to 50% data recovery for medium-sized datagrams. This successful recovery depends on the received IP datagram length and the transmission error probability and results in an improved audiovisual decoding quality¹.

Index Terms — DVB-H, Forward Error Correction, Internet Protocol, Link Layer, MPEG, Multi Protocol Encapsulation, OSI, Reed-Solomon.

I. INTRODUCTION

In the fall of 2004, the European Telecommunications Standards Institute (ETSI) approved the Digital Video Broadcast Handheld (DVB-H) standard [1] [2], which is specifically tailored to battery-powered mobile reception. Basically, the DVB-H standard is an extension of the DVB-T standard with extra features added to the physical and link layer. With respect to the DVB-T physical layer, the DVB-H physical layer is extended with Transmission Parameter Signaling (TPS) to fasten service discovery, a 4K-mode to trade-off Doppler sensitivity versus echo sensitivity and an in-depth symbol interleaver to increase the robustness for e.g. impulse noise. The DVB-H link layer uses a Time-Division-Multiplex (TDM) broadcast technique, called time-slicing, to

¹ Onno Eerenberg is with Trident Microsystems, Prof. Holstlaan 4, 5656 AA Eindhoven, The Netherlands. (e-mail: onno.eerenberg@tridentmicro.com).

Arie Koppelaar is with NXP Semiconductors, Prof. Holstlaan 4, 5656 AA Eindhoven, The Netherlands. (e-mail: arie.koppelaar@nxp.com).

Armand M. Stuivenwold is with NXP Semiconductors, Gerstweg 2, 6534AE Nijmegen, The Netherlands. (e-mail: armand.stuivenwold@nxp.com).

Peter H. N. de With is with Cyclomedia and Eindhoven University of Technology, Den Dolech 2, 5600 MB, The Netherlands (e-mail: p.h.n.de.with@tue.nl).

transmit a service, enabling power-efficient service reception and service discovery in neighboring cells, using a single front-end. Furthermore, the DVB-H link layer is foreseen with a second Forward Error Correction (FEC) layer, called MPE-FEC, applying a [255,191,65] Reed-Solomon (RS) mother code with distance d that allows to correct up to e erasures, if the erroneous positions are known, or t unknown errors according to the inequality

$$2t + e < d. \quad (1)$$

This additional MPE-FEC protects the received service against various reception impairments, e.g. Carrier-to-Noise Ratio (CNR), Doppler or impulse noise influences. Because DVB-H has added these special features to the link layer, a traditional DVB-T network can be used for broadcasting DVB-H services. However, under poor reception conditions, the MPE-FEC may not be able to correct all corrupted received data and as a result, the link layer will potentially lose all correctly received data of that particular service burst.

Efficiency and robustness are two main aspects that characterize a DVB-H link layer, which forms an interface between the OSI Layer-1 (radio layer) [10] operating in the physical domain and the OSI Layer-3 (network layer). The DVB-H broadcast stack is depicted in Fig. 1.

A. Efficiency aspects

The efficient design of a DVB-H link layer relies on two aspects. The first aspect demands that the traditional system resources such as memory footprint, bandwidth, logic area and cycle consumption, are used efficiently. The second aspect aims at the usage of both reliably and unreliably received data to maximize data recovery and optimizing the data reconstruction using MPE-FEC erasure decoding. Erasure information enables the distinction between correctly, potentially correctly and incorrectly received data, which when scarcely assigned, leads to a higher flexibility in the usage of error correction, see inequality (1).

B. Robustness aspects

A first robustness aspect of a DVB-H link layer is to prevent this OSI-layer from collapsing when incorrect data is processed. A second robustness aspect of the DVB-H link layer is that correctly received IP data shall always be transferred to the network layer, regardless the outcome of the MPE-FEC decoding stage. Furthermore, corrected IP datagrams that are part of a defect MPE-FEC frame after FEC should also be transferred to the network layer.

This paper contributes to both improving efficiency and robustness aspects. We will propose a system design with an increased efficiency by only forwarding once correctly

received IP datagrams to the network layer, thereby avoiding data duplication and associated bandwidth. The robustness is improved when correct IP datagrams are recovered from a corrupted MPE-FEC frame after FEC. Our proposal solves the parsing mechanism required when using variable-length IP datagrams, by employing a special form of address information to successfully readout the correctly received IP datagram. The key to our robustness improvement is based on two aspects. First, our receiver stores the locator information that is present in the service burst, enabling the location of correctly received IP datagrams. Second, additional reliability information, which is derived from the incoming data as well as from the FEC, is stored and used for improved FEC decoding and retrieval of potentially corrected IP datagrams.

The paper is divided as follows. Section II elaborates on Multi-Protocol Encapsulation (MPE) and Multi-Protocol Encapsulation Forward Error Correction (MPE-FEC) deployed in DVB-H, including the associated MPE-FEC frame. Section III introduces the DVB-H broadcast protocol stack, including the extensions proposed in this paper. Section IV discusses the Internet Protocol Entry Table (IPET), the Corrected Row Index Table (CRIT) concepts and 2-bit erasure information required for IP-recovery. In this section the combination of the reliability information is used for additional robustness. Section V presents a robust DVB-H link layer architecture and investigates IP recovery on the basis of simulations and measurements on an actual DVB-H link layer implementation. Finally, conclusions are presented in Section VI.

II. MULTI PROTOCOL ENCAPSULATION (MPE) AND MULTI-PROTOCOL ENCAPSULATION FORWARD ERROR CORRECTION (MPE-FEC)

This section elaborates on the container framework for transmitting IP datagrams and RS-parity data. Unlike other DVB members such as DVB-T, DVB-C and DVB-S, DVB-H is a datagram-based broadcast system. In the traditional DVB standards, a Packetized Elementary Stream (PES) container is

used to transmit one or more audiovisual access units. In DVB-H, a Multi Protocol Encapsulation (MPE) section [3], which is compliant with the MPEG-2 private section format [5], is used to transmit a single IPv4- or IPv6-based datagram. Optional RS-parity data is transmitted using a Multi-Protocol Encapsulation Forward Error Correction (MPE-FEC) section. In order to deploy an MPE section for DVB-H, the private section format [5] is modified, where the *MAC_address_1*, ..., *MAC_address_4* fields are replaced by the *real_time_parameters* fields [3]. The *real_time_parameters* fields contain four parameters required by the DVB-H link layer to perform service synchronization, correct storage of IP datagrams and RS-parity in the MPE-FEC frame and enable power down of the receiver's front-end [4]. The section carrying the RS-parity data is called MPE-FEC section [4], is compliant with the *DSMCC-section* type and equipped with the *real_time_parameters* fields. The four *real_time_parameters* information fields are summarized below.

A. *Real_time_parameter: Address*

The *address* field contains the MPE-FEC frame start address position where to store the first Byte of the section payload, enabling proper placement of received IP datagrams in the application data table or RS-parity data in the RS-data table.

B. *Real_time_parameter: Delta_t*

The *delta_t* field indicates when the next service burst is broadcasted, enabling the receiver to power down between two service bursts.

C. *Real_time_parameter: Table_boundary*

The *table_boundary* flag, when set to "1", indicates the last section for the application data table or RS-data table.

D. *Real_time_parameter: Frame_boundary*

The *frame_boundary* field, when set to "1", denotes that the current section is the last section within the current burst, which is either an MPE section, without available FEC data, or an MPE-FEC section.

Figure 1 indicates an MPE-FEC frame with column-wise storage of IP datagrams and RS-parity data, each in their own table. Compared to the height of an MPE-FEC frame, an IP datagram can be smaller, larger or equal to the MPE-FEC frame height, whereas the length of the RS-parity data equals that of the MPE-FEC table height, which can be 256, 512, 768 or 1,024 rows. Because the storage start position of an IP datagram in the MPE-FEC frame does not necessarily start at a fixed position, proper placement is guaranteed by means of the *real_time_parameters* field *address*. This field enables correct placement of IP datagrams and RS-parity data in the MPE-FEC frame for the situation that due to transmission errors, an MPE and/or MPE-FEC section is corrupted or even lost. In a basic DVB-H link-layer implementation, the IP datagram storage address is only used during reception of that particular datagram. In order to increase the robustness of a DVB-H receiver, this address information is locally stored for future processing. This will be discussed in following section.

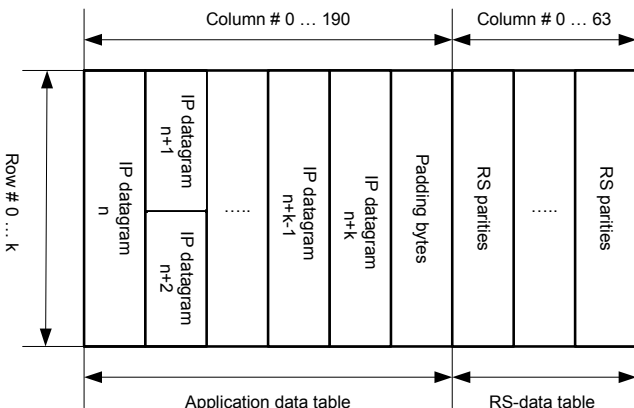

Fig. 1. DVB-H MPE-FEC frame. At the left, the column-wise storage of IP datagram data. At the right, the column-wise storage of RS-parities.

III. DVB-H PROTOCOL STACK

DVB-H is a broadcast transmission system for datagrams [12]. These datagrams is based on IPv4 or IPv6 [8][9], or other network layer datagrams [6] [7] and are encapsulated in MPE-sections [3]. Figure 2 depicts the DVB-H protocol stack and indicates that the output of the DVB-H link layer consists of IP datagrams, Service Information (SI) sections and Program Specific Information (PSI) sections [13]. The SI and PSI sections are forwarded to the receiver middleware, while the IP datagrams are forwarded to the network layer. According to the OSI model, a layer provides service to the higher layer. Although the data provided by the DVB-H link layer is equipped with means for error detection enabling the upper layer to reject incorrect data, only correct data is provided to the network layer, thereby improving the link layer efficiency. The rationale behind this is that in a battery-powered device, energy is a scarce resource and should only be spent on essential processing. The protocols deployed in DVB-H enable error detection at the link layer level for both SI/PSI sections and MPE-FEC/MPE sections, see Fig. 4. For the SI/PSI information, only error detection is available, based on a Cyclic Redundancy Check (CRC), see Fig. 4. If a filtered SI/PSI section is correct, this section is forwarded to the middleware. For MPE-FEC/MPE sections, again a CRC is present indicating the correctness of that section. For the situation that FEC is not present (see Figure 4), the IP datagrams from correct MPE sections are forwarded to the network layer. For the situation that FEC is present, all IP-based data is stored in the MPE-FEC frame, prior to performing this FEC, whereby the CRC result is also used by the 2-bit erasure information generation.

For a typical reception situation, the incorrectly received IP datagrams are corrected by FEC, enabling proper readout of all IP datagrams, as described by the pseudo code in Fig. 3. In case of a FEC failure, potentially all correctly received IP datagrams are also lost. The root cause for this datagram loss is the absence of locator information indicating the location of a correctly received IP datagram and the usage of variable-length IP datagrams. In DVB-H, IP datagram parsing relies on the availability of the IP datagram length field, which is present in each IP datagram header, see also the pseudo code in Fig. 3. When such length field is corrupted or absent due to

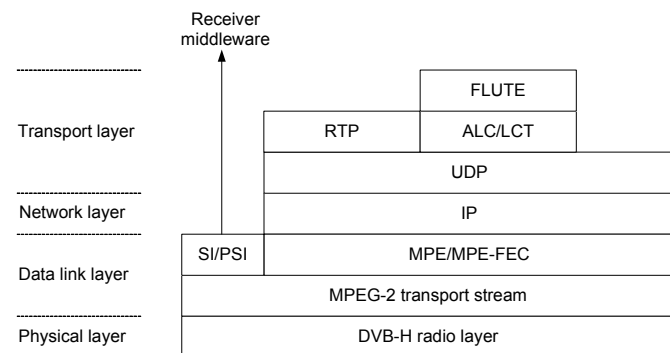

Fig. 2. DVB-H broadcast protocol stack.

```

Application_data_table_read_address=0;
no_padding=true; no_end_of_table=true;
While ( no_padding and no_end_of_table ) do{
    Determine_IP_version();
    If ( IPv4 or IPv6 ){
        Determine_IP_datagram_length();
        Forward_IP_datagram_to_network_layer();
        Application_data_table_read_address+= datagram_length;
        If (Application_data_table_read_address == last_address)
            no_end_of_table=false;
    }else{
        no_padding=false;
    }
}
    
```

Fig. 3. Pseudo code describing the readout of IP datagrams from the MPE-FEC application data table.

a transmission error, the parsing mechanism fails and cannot recover from this failure for the current MPE-FEC frame.

The loss of correctly received IP datagrams could potentially be avoided when all correctly received IP datagrams are also forwarded to the network layer, prior to the storage in the MPE-FEC frame. When after FEC the MPE-FEC frame is corrected, all IP datagrams are forwarded to the network layer, including the IP datagrams that have been forwarded prior to FEC. Although IP-based communication can be robust against data duplication and out-of-order reception, this robustness is not provided by the Internet Protocol itself, but depends on the capabilities of the higher layer.

According to the broadcast stack depicted in Fig. 2, IP-based video broadcasting deploys the Real-Time Protocol RTP [16] on top of the User Datagram Protocol (UDP) [11].

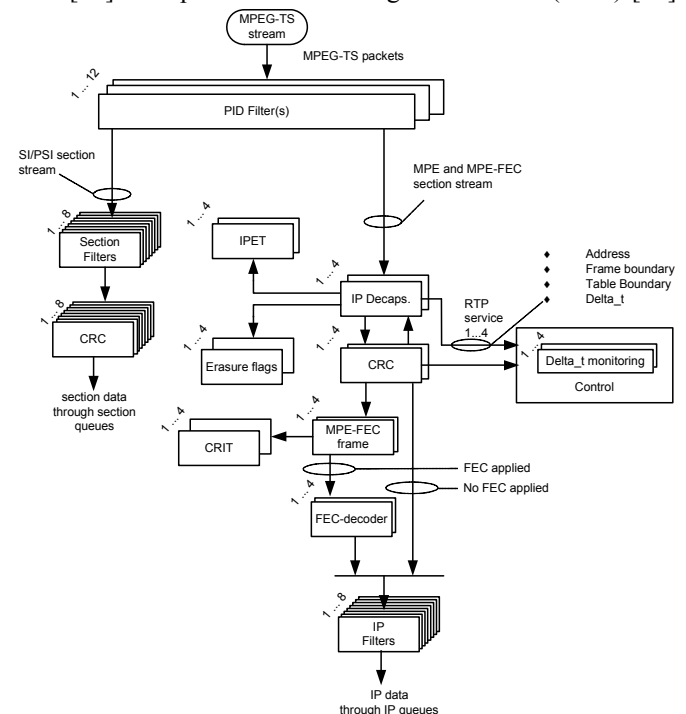

Fig. 4. DVB-H filter model for SI/PSI data and FEC-based and FEC-less IP reception.

Although the UDP protocol provides means for multiplexing and error detection, it lacks support for reordering or data duplication. Support for reordering or data duplication is provided by the RTP layer. This layer is equipped with a sequence counter to determine the position of an RTP packet within a sliding window. For broadcasted streaming, the throughput timing of the packets is constrained and can be controlled by the RTP protocol. The switches and routers in the network will safeguard the proper forward passing of the packets. The combination of these mechanisms ensures timely delivery of packets in (near)-sequential order. However, for battery-powered devices data duplication or out-of-order delivery has to be minimized to preserve energy consumption.

For this reason, we propose that all received IP datagrams are stored in the MPE-FEC frame *prior* to FEC. After FEC, either all IP datagrams are extracted from the MPE-FEC frame, or only the correctly received IP datagrams and potentially the error-corrected IP datagrams. In this way, additional out-of-order delivery or data duplication is avoided, as all IP datagrams are finally extracted in sequential order. The robust storage of IP datagrams and RS parities can be corrupted by transmission errors, which would result in an incorrect placement in the MPE-FEC frame, provided that no other means would be available. For this purpose, the DVB-H standard facilitates address (locator) information, enabling proper storage of datagrams and RS parity data.

Another proposal in this paper is based on the additional storage of the received locator information, creating an *Internet Protocol Entry Table* (IPET), see Fig. 4. This table improves the decoder in two aspects: (1) it avoids data duplication for the situation that FEC corrects all erroneous data, and (2) it enables retrieval of correctly received IP datagrams from defect MPE-FEC frames after FEC. Further robustness improvement is obtained by combining reliability information stored in IPET, the erasure flag memory and the result of FEC, which is stored in the *Corrected Row Index Table* (CRIT). The combined use of the above parameters potentially results in additional data recovery from defect MPE-FEC frames. This additional robustness requires extra embedded memory for temporally storage. Section IV will further elaborate on IP recovery, involving the combined use of reliability information.

IV. DVB-H LINK LAYER IP RECOVERY

This section elaborates on the 2-bit erasure information, IPET and CRIT information and the combined use of this reliability information.

One of the design aspects of a robust DVB-H link layer is the guarantee that correctly received IP datagrams are always forwarded to the network layer, regardless the outcome of the FEC. Moreover, forwarding error-corrected IP datagrams to the network layer, present in a defect MPE-FEC frame after FEC, further improves the link layer robustness. Retrieval of correctly received IP datagrams involves the presence of locator information, which is stored in an IP Entry Table

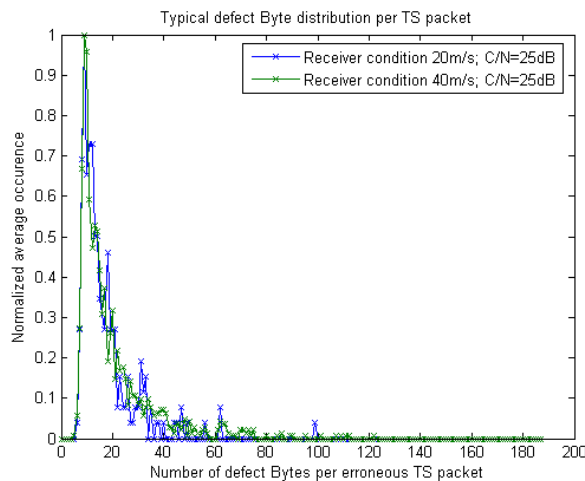

Fig. 5. Typical number of defect Bytes in a TS packet received under different conditions, whereby the transmission parameters correspond to 16 QAM, 8k and guard interval 1/8.

(IPET). A robust DVB-H link layer deploys 2-bit erasure information [14] to fully exploit the error correction capabilities of the applied FEC. We have found that this 2-bit erasure information can *also* be used in defect MPE-FEC frames, indicating the reliability status on a per symbol basis, thereby facilitating in the readout of corrected IP datagrams in a defect MPE-FEC frame after FEC. However, knowledge on a per symbol basis concerning the reception condition is not sufficient for readout of corrected IP datagrams from a defect MPE-FEC frame after FEC. Therefore, in this paper we add an additional table, called the *Corrected Row Index Table* (CRIT), which keeps track of erroneous and correct rows in an MPE-FEC table after FEC.

A. Two-Bit Erasure Information

This sub-section briefly introduces the 2-bit erasure information deployed in an efficient link-layer implementation. The exploitation of these bits is discussed later in this paper. Here, we only provide background information.

Bytes constructing an MPEG-2 Transport Stream (TS) [5] packet that traveled across an error-prone channel may have a different reliability status. Although a DVB-H channel decoder is equipped with a [188,204,16] RS FEC, an MPEG-2 TS packet can still be defect after channel decoding. For two different non-static reception conditions, Fig. 5 indicates the number of erroneous Bytes per MPEG-2 TS packet. Figure 5 shows that a majority of the Bytes may still be correct. This measurement highlights that the 2-bit erasure information is a powerful indicator for exploiting this phenomenon. With 2-bit erasure information, a distinction can be made between correct, hard-erased and soft-erased reception conditions. The first two reception situations correspond to the presence and absence of an MPEG-2 TS packet, whereas in the last reception situation, the received MPEG-2 TS packet is present, but has its Transport Error Indicator (TEI) flag set to unity, indicating that the channel decoder FEC could not correct this packet. In DVB-H, the link-layer FEC can benefit

from this additional information for enabling the trade-off between hard- and soft-erasures prior to FEC, as indicated by Equation (1), see [15]. The 2-bit erasure information is stored in the erasure flag memory, which can be regarded as a Look-Up-Table (LUT).

For each MPE-FEC symbol constructing the MPE-FEC table, 2-bit erasure information is generated by the IP de-encapsulation filter chain. If each symbol of the application data table would have its own 2-bit erasure information, a memory footprint of 65,280 Bytes is required. Fortunately, the symbols of the application data table are transmitted via TS packets, resulting in multiple symbols sharing the same 2-bit erasure information. For the situation that the MPE-FEC frame has 1,024 rows, where the service burst does not apply puncturing or shortening, the erasure flag memory has 1,420 entries storing the 2-bit erasure flag followed by a length indicator, which indicates the amount of consecutive symbols that share this erasure flag. The length indicator requires 8 bits, as the maximum payload of an MPEG-2 TS packet can contain up to 184 Bytes. The corresponding erasure flag memory requires a little less than 1,800 Bytes.

B. Internet Protocol Entry Table (IPET)

The purpose of the IPET is to facilitate the retrieval of correctly received IP datagrams in a defect MPE-FEC frame after FEC decoding. IPET stores the *real time parameters* field *address*. IPET is a Look-Up-Table (LUT), storing the MPE-FEC application data table start address position for each correctly received IP datagram. This concept can be

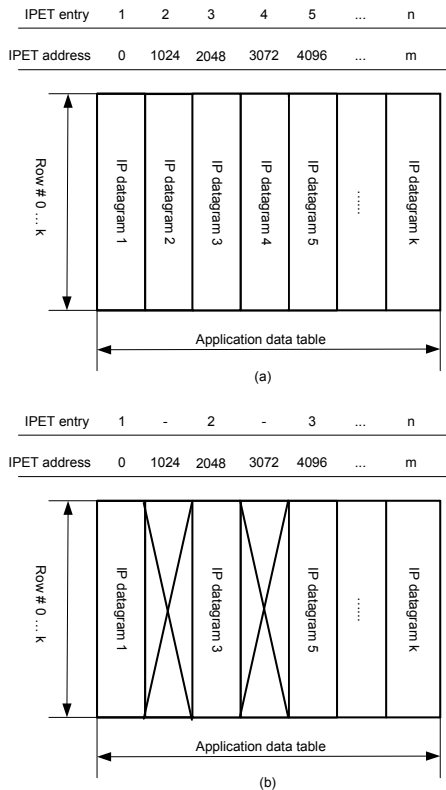

Fig. 6. MPE-FEC frame. (a) Correct MPE-FEC frame. (b) Incorrect MPE-FEC frame after FEC.

extended such that the MPE-FEC start address position of *incorrectly* received IP datagrams are also stored, provided that this start address is available. The table provides an extension indicator signal, requiring an additional output per LUT entry, which signals whether the IP datagram has been received correctly or incorrectly. The LUT size depends on the maximum number of entries, which equals the maximum number of IP datagrams that can be stored in the application data table. The maximum address space for an application data table is 191 kBytes, which occurs for the situation that the application data table has 1,024 rows. The minimum datagram size that any host must be able to handle is 576 and 1,280 octets for IPv4 and IPv6, respectively, which means that IPv4 determines the IPET size. The IPET size is obtained by the ratio between the 191-kByte storage space and the 576-octets based IP datagram, resulting in an IPET size with 340 entries, capable of storing an 18-bit address. This leads to a memory footprint of 765 Bytes. Although IPET is dimensioned for 576-Bytes based IP datagrams, this does not exclude the usage of smaller sized IP datagrams. In a typical DVB-H broadcast deploying an IPv4-based service burst of 1,024 rows, around 50 % of the IP datagram has a size larger than 1,024 Bytes, while the other

50 % has a size around 400 Bytes. The variation in size is caused by the nature of the transmitted information (video, audio and data). This variation can be exploited to minimize the IPET memory footprint to an average-case size of 765 Bytes. Such a packet length distribution results in a number of IP datagrams that fits well in the optimized IPET size.

C. Corrected Row Index Table (CRIT)

The purpose of this additional table is the storage of the FEC erasure decoding result, in order to combine it with other reliability information.

Retrieval of *correctly* received IP datagrams from a defect MPE-FEC frame is facilitated by the IPET. However, the information from this table is not sufficient for the retrieval of link-layer FEC-corrected IP datagrams in a defect MPE-FEC frame. In order to retrieve *incorrectly* received IP datagrams, which are corrected afterwards by the link-layer FEC, a second table is required. This second table is the *Corrected Row Index Table* (CRIT), which stores on a per row basis the result of the FEC decoder. The FEC decoder result indicates that a row is either correct or incorrect, requiring a single information bit. For an application data table consisting of 1,024 rows, the memory footprint corresponds to 128 Bytes.

D. IP recovery using the combined reliability information

The IPET, CRIT and the 2-bit erasure information discussed in the previous sub-sections, are combined to enable IP recovery in defect MPE-FEC frames after FEC. Let us assume an MPE-FEC frame consisting of 1,024 rows as depicted in Fig. 6. Figure 6(a) shows the first 5 IP datagrams located in a correct MPE-FEC frame, whereas Fig. 6(b) shows an MPE-FEC frame with IP datagrams that were both correctly and incorrectly received, while the MPE-FEC frame

TABLE I
SYMBOL RECOVERY IN DEFECT MPE-FEC FRAME USING 2-BIT ERASURE
INFORMATION IN COMBINATION WITH THE INFORMATION FROM THE
CORRECTED ROW INDEX TABLE

2-bit erasure flag	Corrected Row Index Table (CRIT)	Symbol recovered
Correct "00"	Corrected "0"	N/A
Correct "00"	Not corrected "1"	N/A
Hard erased "11"	Corrected "0"	YES
Hard erased "11"	Not corrected "1"	NO
Soft erased "01"	Corrected "0"	YES
Soft erased "01"	Not corrected "1"	NO

could not be fully corrected by the FEC. For the situation that the IP datagram size of the first 5 IP datagrams corresponds to 1,024 Bytes, the first 5 consecutive IPET entries contain the addresses $IPET=\{0; 1,024; 2,048; 3,072; 4,096; \dots\}$, which corresponds to the reception of the MPE-FEC table as depicted in Fig. 6(a). For the reception situation with errors as depicted in Fig. 6(b), the first 3 consecutive IPET entries contain the addresses $IPET=\{0; 2,048; 4,096; \dots\}$. From this example, it becomes clear that in a defect MPE-FEC frame,

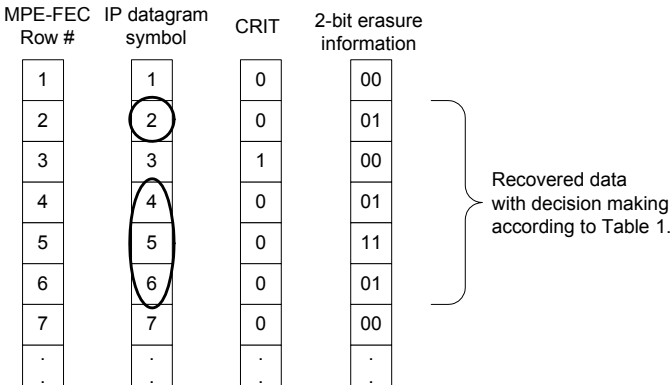

Fig. 7. Example of recovered IP datagram data. Dark circles indicate recovered symbols.

the correctly received IP datagrams can be retrieved from the MPE-FEC frame, with the aid of the IP datagram length field, located in the IP datagram header and the start position stored in IPET. Furthermore, an IPET discontinuity becomes apparent, when the IPET entry for a particular IP datagram plus its length, does not correspond to the next IPET entry. Note that when a discontinuity region consists of multiple IP datagrams, this cannot be derived from the previous calculation and becomes only visible when the first IP datagram is recovered. After recovery, it can be detected that the next IPET entry is not equal to the calculated address.

For the situation that an MPE-FEC frame cannot be FEC corrected, there may still be corrected IP datagrams. The location of incorrectly received IP datagrams within the MPE-FEC frame is indicated by the IPET discontinuities. After deriving the start position of a potentially corrected IP datagram, a comparison between the CRIT and the 2-bit erasure information is performed, as indicated by Fig. 7 for all

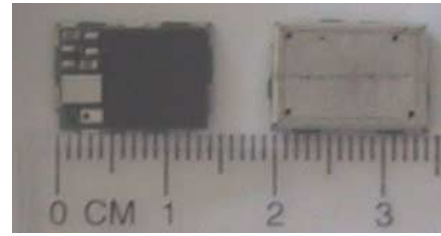

Fig. 8. Multi-Chip Module of a DVB-H receiver. At the left side, an unshielded package and at the right side, the shielded package.

the addresses in the discontinuity interval, using the relation between the 2-bit erasure flag and the CRIT information as depicted in Table I. With the information stored in the CRIT, knowledge on corrected and non-correctable MPE-FEC rows is available. Two situations lead to recovery, as depicted in Table I and indicated by the dark circles in Fig. 7. Note that the IP datagram data recovery as depicted in Fig. 7 is an illustration only for clarification purposes. In practice, up to 184 IP datagram Bytes can be encapsulated per TS packet, resulting in 184 consecutive IP datagram Bytes (symbols), having an equal 2-bit erasure value.

V. EXPERIMENTAL RESULTS

Figure 8 shows an actual DVB-H receiver on the basis of a Multi-Chip Module (MCM). The MCM consists of a silicon tuner and baseband chip interconnected via a laminate, packaged in a Ball Grid Array (BGA). Figure 9 shows a basic terminal block diagram visualizing the DVB-H receiver. At the left-hand side, an RF signal enters the DVB-H receiver. The silicon tuner provides a zero-IF signal to the channel decoder and demodulator, resulting in an MPEG-2 TS. This TS signal enters the link layer, which filters the requested SI, PSI and service burst(s) according to the filter model as depicted in Fig. 4. Finally, the received SI, PSI sections and IP datagrams are forwarded to a host processor (at the right) for further processing.

The above-mentioned novel MCM was exploited for validating the presented IP datagram recovery scheme. This has resulted in a practical validation of our proposed solution. Additionally, we have simulated the IP recovery prior to the

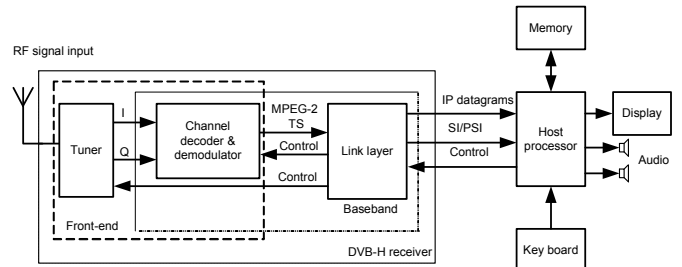

Fig. 9. Basic DVB-H terminal block diagram.

practical implementation and validation. Therefore, we report first the simulated and measured IP recovery performance.

A. Simulated IP recovery

Verification and validation of an embedded DVB-H link layer requires a dedicated data generator and a corresponding

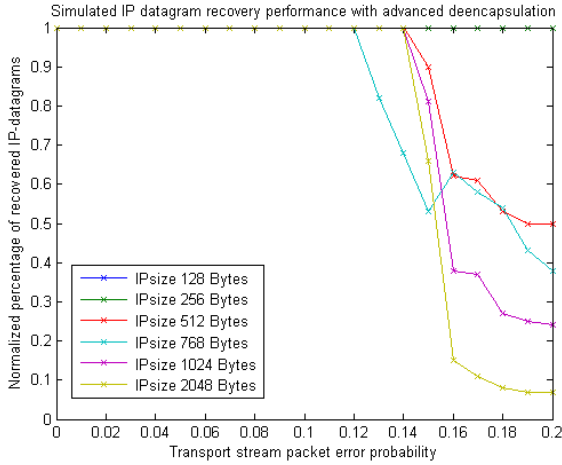

Fig. 10. Simulated IP datagram recovery for different IP datagram sizes and TS packet error probability using erasure information.

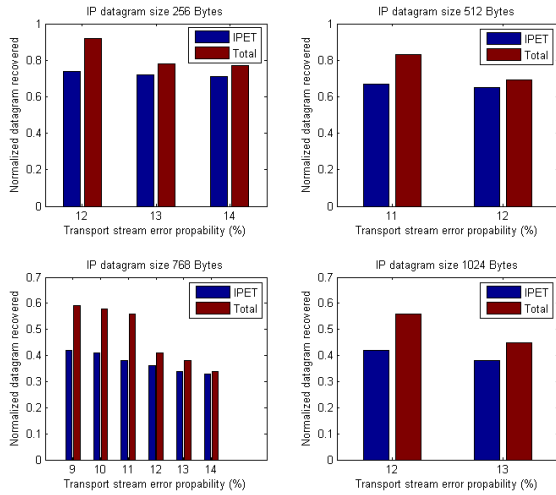

Fig. 11. IP datagram recovery process based on IPET-only versus IP datagram recovery process on the basis of combined reliability information.

data analyzer [15]. This tool set is also used to simulate the IP recovery performance, prior to an actual DVB-H link-layer implementation.

Our starting point forms a TS with an on the average constant error probability, whereby the payload of the corrupted TS packets is indicated with a hard erasure signal by the IP de-encapsulation process. This is the worst-case situation as typically not all Bytes constructing a TS packet are defect, see Fig. 5. Furthermore, correctly received service data is properly stored within the MPE-FEC frame, except for the situation that the section header is located in a defect TS packet, which results in the loss of a complete IP datagram. Figure 10 indicates the simulated IP datagram recovery performance. The simulations indicate that the recovery performance for small-sized IP datagrams, which in practice will not be frequently deployed, is still substantial (more than 60% for 256 Bytes based IP datagrams) and declines with the increase in IP datagram size. The results depicted in Fig. 10

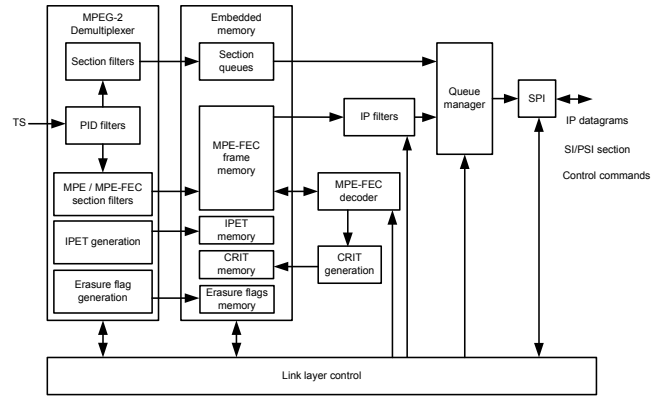

Fig. 12. Block diagram of a robust and efficient DVB-H link layer.

suggest that the gain of IP recovery is limited. However, the deployed erasure assignment is worst-case, since all TS data is flagged hard erased. This will not frequently occur in practice, which is confirmed by the error distribution from Fig. 5, where the probability of all TS packet bytes being defect appears to be low. Figure 11 indicates a comparison between the IP recovery performance based on using the IPET and the combination of all reliability information (indicated as Total). The comparison figure shows that the IP datagram recovery contribution based on the combined reliability information varies but gives always a higher robustness and the improvement can be up to 20 %. However, the experiments show that the additional IP datagram recovery based on the combined reliability information occurs only over a limited range, all depending on the IP datagram size and the transport stream error probability. The diagrams in Fig. 11 indicate that when the error probability increases, the performance improvement of the combined strategy decreases to zero, so that the performance becomes equal to the IPET-only approach. Also, when the error probability is small, Fig. 10 indicates that all IP datagrams are recovered due to FEC, leading to a zero difference in performance between the IPET-only and combined approach.

B. Measured IP recovery

A robust and efficient DVB-H link-layer block diagram is depicted in Fig. 12, which is employed in the MCM-based implementation (see Fig. 8). In the block diagram, at the left-hand side, an MPEG-2 TS enters the DVB-H link layer. Prior to section filtering, Packet IDentifier (PID) filtering is applied to the packet-based TS. Filtered MPEG-2 TS packets are either subjected to SI/PSI section filtering, or MPE / MPE-FEC section filtering, see also Fig. 4. The SI/PSI filter extracts sections, which are required by the middleware and are not protected by an additional FEC, but are equipped with a CRC to determine correctness. The MPE/MPE-FEC filter de-encapsulates the IP and RS-parity data from the selected service burst and stores the result in the MPE-FEC frame, enabling an optional FEC to correct potential errors. During MPE filtering, the IPET generator derives locator information from the incoming data, which is stored in the IPET memory.

During reception of the service burst, the erasure-flag generation fills the erasure-flag memory with 2-bit erasure information, which is derived from the whole filter chain, consisting of PID filtering and MPE/MPE-FEC section filtering. After receiving the whole service burst, the MPE-FEC decoder is invoked on each MPE-FEC row to correct erroneously received data. The CRIT generator stores in the CRIT memory on a per row basis, the result of the MPE-FEC decoder. Readout of the MPE-FEC memory may involve an optional IP filter, avoiding forwarding of undesired service data, further improving the receiver power efficiency. Although this filter does not contribute to the IP retrieval performance in defect MPE-FEC frames, it is mentioned here for the sake of completeness. The filtered IP datagrams and the successfully received SI/PSI information are forwarded over a bi-directional Serial Peripheral Interface (SPI), which is a popular interface deployed in mobile phone architectures. Finally, the receiver is controlled via a command set over SPI.

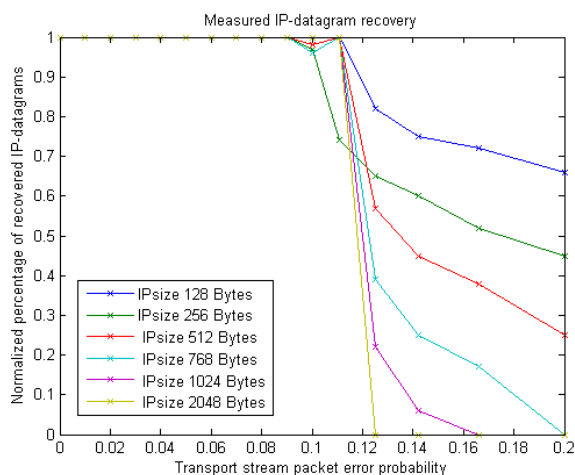

Fig. 13. Measured IP datagram recovery for different IP datagram sizes and TS packet error probability, using erasure FEC decoding.

Let us now discuss the practical IP datagram recovery performance of the MCM implementation.

Figure 13 portrays the IP datagram recovery performance for various TS packet error rates. For each IP datagram size, an MPEG-2 TS stream has been generated containing 100 service bursts, which are broadcasted in time-sliced form, using a period of 3 seconds, resulting in a 5-minute test sequence. Although in Section IV we limit the number of IPET entries to 340 IP datagrams to optimize on memory footprint, the receiver in Fig. 8 supports 1,528 entries, enabling full IP datagram recovery, starting from IP datagrams of 128-Byte size. The service burst deploys an MPE-FEC frame size of 1,024 rows without shortening and puncturing. The IP recovery depicted in Fig. 13 is obtained by comparing the actually received IP datagrams with the expected amount of IP datagrams using the analyzer described in [15]. For the situation that all expected IP datagrams are received, the normalized recovery rate becomes unity, which means that an erroneous MPE-FEC frame can be successfully corrected by

the link-layer FEC. In Fig. 13 it is shown that for a TS-packet error rate beyond 10 %, the MPE-FEC frame cannot be fully corrected by the FEC. Note that for TS-packet error rates beyond 10 %, it is still possible that the DVB-H link layer can fully correct the service burst. However, the number of fully corrected MPE-FEC frames after the link-layer FEC declines with an increase in TS-packet error rate. This decline appears for all IP datagram sizes from 12 % error rate onwards.

The results depicted in Fig. 13 deviate from the simulation results shown in Fig. 10, in the sense that the theoretical results are slightly better as the multiple performance drops are occurring from 12% to 14 % TS packet error rate. The primary reason for this is the difference between the deployed IP encapsulation techniques. The IP encapsulation deployed in the simulation is such that after the last MPE- or MPE-FEC section Byte, only stuffing Bytes are used to fill up the TS packet. The IP encapsulation deployed in the MCM implementation case allows the next MPE-section to start directly in the TS packet that contains the last Byte of the current MPE- or MPE-FEC section, provided that there is sufficient place. This case is more likely to occur in practice due to its higher efficiency. However, this leads to more corrupted data, as the TS packet holds the last part of the current section and start of a new section, which results in an CRC failure for the current section and the complete loss of the new section due to the loss of the section header. This leads to a higher amount of erased symbols in the MPE-FEC frame, directly influencing the FEC correction capabilities.

Furthermore, at 10% TS-packet error rate, there is a slight performance dip. This small dip is caused by the TS-packet error distribution and the corresponding erasure assignment by the IP de-encapsulation process. Such a dip is also observed in simulations when applying different error probabilities.

VI. CONCLUSIONS

For regular reception robustness, the DVB-H link layer is equipped with Forward Error Correction (FEC). We have designed a link layer architecture with improved robustness and efficiency, by taking specific actions. First, the improved robustness is obtained by ensuring retrieval of correctly received and error-corrected IP datagrams from defect MPE-FEC frames after FEC. This ensured retrieval is obtained by deploying two LUTs in the link layer receiver, which store reliability information obtained during reception and FEC. The first LUT (IPET) indicates the location of correctly received IP datagrams, while the second LUT (CRIT) holds the result of the link layer FEC. The combined use of IPET, CRIT and 2-bit erasure information enables the retrieval of FEC corrected IP datagrams.

Second, to preserve energy and bandwidth, we have avoided data duplication introduced in the receiver link layer. This has been achieved as an additional bonus by deploying the above IPET and CRIT tables. Especially the IPET table

enables the separation of variable sized IP datagrams. This ensures that datagrams can be forwarded individually and only once to the network layer, correctly received, or FEC corrected.

The third benefit involves the FEC corrected datagrams, which are retrieved on the basis of the combined reliability information. This combined information consists of IPET, CRIT and 2-bit erasure information. The optimized memory footprint for IPET and CRIT requires only an additional memory of 1 kByte.

Experiments have shown that up to 80 % data recovery is still possible for medium-sized IP datagrams, which drops down to less than 10 % for large-sized IP datagrams. A standard receiver would offer only 60 % data recovery for medium-sized IP datagrams, at the expense of duplicating data in the receiver link layer.

Efficiency is further improved when only correct SI and PSI sections are forwarded to the middleware. As a result, due to avoiding data duplication, less additional data handling occurs at higher OSI-layers, which lowers the power consumption.

REFERENCES

- [1] ETSI EN 302 304: "Digital Video Broadcasting (DVB); Transmission System for Handheld Terminals". (DVB-H).
- [2] Draft ETSI TR 102 377 v1.1.1: "Digital Video Broadcasting (DVB); DVB-H Implementation Guidelines".
- [3] ISO/IEC 13818-6: "Information Technology - Generic Coding of Moving Pictures and Associated Audio Recommendation (Extensions for DSM-CC)".
- [4] ETSI EN 301 192: "Digital Video Broadcasting (DVB); DVB specification for data broadcasting".
- [5] ISO/IEC 13818-1: "Information Technology - Generic Coding of Moving Pictures and Associated Audio Recommendation H.222.0 (systems)".
- [6] ISO/IEC 8802-2 Logical Link Control (LLC).
- [7] ISO/IEC 8802-1a SubNetwork Attachment Point (SNAP) specification, IP-datacast baseline specification; Specification of interface I_MT A80.
- [8] J. Postel, "Internet Protocol - DARPA Internet Program Protocol Specification," RFC 791, USC/Information Sciences Institute, September 1981.
- [9] S. Deering and R. Hinden, "Internet Protocol, Version 6 (IPv6) Specification", RFC 2460, December 1998.
- [10] ISO/IEC 7498-1: "Information technology - Open Systems Interconnection - Basic Reference Model: The Basic Model".
- [11] J. Postel, "User Datagram Protocol", RFC 768, 28 August 1980.
- [12] ETSI TR 102 469: "Digital Video Broadcasting (DVB); IP Datacast over DVB-H: Architecture".
- [13] ETSI TS 102 471: "Digital Video Broadcasting (DVB); IP Datacast over DVB-H: Electronic Service Guide (ESG)".

- [14] A.G.C. Koppelaar, O. Eerenberg, L.M.G.M. Tolhuizen and V. Aue, "Restoration of IP-datagrams in the DVB-H link-layer for TV on mobile", Proc. ICCE 2006, Las Vegas (NV), Jan. 2006, pp. 409-410.
- [15] O. Eerenberg, P. Wendrich, E.H.W. van Orsouw and P.H.N. de With, "Efficient Validation/Verification of a Robust DVB-H Link Layer", Proc. ICCE 2007, Las Vegas (NV), Jan. 2007, pp. 15-16.
- [16] H. Schulzrinne, S. Casner, R. Frederick and V. Jacobson, "RTP: A Transport Protocol for Real-Time Applications", RFC 1889, January 1996.

BIOGRAPHIES



Onno Eerenberg was born in Zwolle, the Netherlands, in 1966. He graduated from the Polytechnical College in Amsterdam in 1992. He joined Philips Research Laboratories Eindhoven, The Netherlands where he worked in the Magnetic Recording Systems department on digital video and data recording systems. He was involved in several European research projects in this area and was involved in the implementation of e.g. video compression systems. He received a MSc degree in engineering product design in 1998 from the University of Wolverhampton, UK. He is currently working for Trident Microsystems as a member of the video innovation team. He holds several US patents and patent applications in the field of digital recording and digital video transmission. Furthermore, he is co-author of two book chapters.



Peter H. N. de With graduated in electrical engineering from the University of Technology in Eindhoven. and received his Ph.D. degree from the University of Technology Delft, The Netherlands. He joined Philips Research Labs Eindhoven and became a member of the Magnetic Recording Systems Department. From 1985 to 1993, he was involved in several European projects on SDTV and HDTV recording. In this period, he contributed as a principal coding expert to the DV standardization for digital camcording. In 1994, he became a member of the TV

Systems group at Philips Research Eindhoven, where he was leading the design of advanced programmable video architectures. In 1996, he became senior TV systems architect and in 1997, he was appointed as full professor at the University of Mannheim, Germany, at the faculty Computer Engineering, where he was heading the chair on Digital Circuitry and Simulation. Between 2000 and 2007, he was with LogicaCMG Eindhoven (now Logica) as a principal consultant, and also professor at the University of Technology Eindhoven, at the faculty of Electrical Engineering. Since 2008, he is Vice President Video Technology at Cyclomedia Technology, The Netherlands. He has written and co-authored over 200 papers on video coding, architectures and their realization. Regularly, he is a teacher of the Philips Technical Training Centre and for other post-academic courses. He regularly received the IEEE CES Transactions Paper Award for co-authored papers, and the VCIP Best Paper Award. In 1996, he obtained a company Invention Award. Mr. de With is Fellow of the IEEE (2007), program committee member of the IEEE CES and ICIP, chairman of the Benelux community for Information and Communication Theory, former scientific board member of CMG, scientific advisor of the Dutch Imaging school ASCII, IEEE ISCE and board member of various working groups.