

Statistical approach to identify the discharge source in MV cables and accessories

Citation for published version (APA):

Mousavi Gargari, S., Wouters, P. A. A. F., Wielen, van der, P. C. J. M., & Steennis, F. (2008). Statistical approach to identify the discharge source in MV cables and accessories. In *Proceedings of 2008 International Conference on Condition Monitoring and Diagnosis : Beijing, China April 21 - 24, 2008* (pp. 1203-1206). Institute of Electrical and Electronics Engineers. <https://doi.org/10.1109/CMD.2008.4580504>

DOI:

[10.1109/CMD.2008.4580504](https://doi.org/10.1109/CMD.2008.4580504)

Document status and date:

Published: 01/01/2008

Document Version:

Publisher's PDF, also known as Version of Record (includes final page, issue and volume numbers)

Please check the document version of this publication:

- A submitted manuscript is the version of the article upon submission and before peer-review. There can be important differences between the submitted version and the official published version of record. People interested in the research are advised to contact the author for the final version of the publication, or visit the DOI to the publisher's website.
- The final author version and the galley proof are versions of the publication after peer review.
- The final published version features the final layout of the paper including the volume, issue and page numbers.

[Link to publication](#)

General rights

Copyright and moral rights for the publications made accessible in the public portal are retained by the authors and/or other copyright owners and it is a condition of accessing publications that users recognise and abide by the legal requirements associated with these rights.

- Users may download and print one copy of any publication from the public portal for the purpose of private study or research.
- You may not further distribute the material or use it for any profit-making activity or commercial gain
- You may freely distribute the URL identifying the publication in the public portal.

If the publication is distributed under the terms of Article 25fa of the Dutch Copyright Act, indicated by the "Taverne" license above, please follow below link for the End User Agreement:

www.tue.nl/taverne

Take down policy

If you believe that this document breaches copyright please contact us at:

openaccess@tue.nl

providing details and we will investigate your claim.

Statistical Approach to Identify the Discharge Source in MV Cables and Accessories

S. Mousavi Gargari^{1*}, P.A.A.F. Wouters¹, P.C.J.M. van der Wielen² and E.F.Steennis²

¹ Eindhoven University of Technology, the Netherlands

² KEMA, Arnhem, the Netherlands

*E-mail: s.mousavi@tue.nl

Abstract-- Partial discharge (PD) analysis is a reliable tool to assess the integrity of electrical insulation. Representation and interpretation of the data, obtained from e.g. on-line PD monitoring, are key issues to reveal the discharge source, i.e. defect type, as well as the physical phenomena behind the occurrence. Analyses of various PD patterns such as discharge height distribution presented in this work provide useful statistical parameters to identify the discharge source. Research shows that the 2-parameter Weibull distribution is a reliable model to quantify the characteristics of the patterns of the defect. The model fits well to the charge-height distribution. In addition, trends in the discharge density pattern that occur over long times, can be used as complementary information to discover the discharge nature. It alerts for a possible failure and therefore assists in taking corrective measures to prevent failure. This paper presents the application of such statistical modeling to the area of on-line power cable diagnostics. Data obtained from laboratory experiments as well as field data have been studied.

Index Terms— monitoring, partial discharges, power cable insulation, power cables.

I. NOMENCLATURE

- α scale parameter for Weibull distribution
- β shape parameter for Weibull distribution
- q magnitude of the discharges in pC

II. INTRODUCTION

Medium voltage cable systems constitute a major part of the distribution networks. They suffer from premature failure due to breakdown in the electrical insulation. The analysis of partial discharge activity, which is considered as a symptom of incipient failure, has been long known as a reliable tool to assess the integrity and the quality of the electrical insulation systems. In some cases PD activity can also be considered as a mechanism that causes degradation of the insulation and breakdown of the system. For a medium voltage (MV) cable system, PD measurement is often the only reliable source of information to assess the state of the insulation. Correct interpretation of the observed discharge patterns, e.g. from on-line PD monitoring, can be used to

reveal the discharge source i.e. the defect type as well as the physical phenomena behind the occurrence, and thereafter assist the asset managers on decision making. Until fairly recent, PD diagnostics have been performed mainly off-line, which has considerable disadvantages such as the requirement of removing suspicious components and testing under modified operating condition. This may result in a sub-optimal judgment of the system condition. During the last decades different on-line PD measurement techniques have been proposed which enable the maintenance engineers to trace the impending failures under operating condition. Trending results from on-line PD measurements over time, often allows maintenance personnel to become aware of developing defects [1]. One of the most prominent challenges of on-line techniques is the difficulties in handling a continuous stream of diagnostic data, and interpreting PD signatures and correlate them to a specific defect source. The first one is nowadays hardly an issue owing to advances in computer hardware and pattern recognition techniques [2]. However, the interpretation of the patterns obtained from on-line measurement is still a subject of research, especially for power cables where up to now experience is almost exclusively based on off-line diagnostics. The interpretation of the data can be done by performing statistical analysis on the patterns that are obtained from the measured data. Amongst the most popular ones for PD analysis are pulse height distribution (PHD), pulse phase distribution (PPD) and trend analysis. This work presents the statistical analysis performed on PHD patterns by applying the Weibull model. Also the relation between the key characteristics of this model and the defect type as a tool for on-line MV cable diagnostics is investigated. In addition, the discharge density vs. time pattern, which is used as a complementary pattern, is presented.

III. PD ANALYSIS AND METHODOLOGIES

Detection and location of partial discharges are key issues in preventing the cable system from failures. The interpretation of the acquired data is of crucial importance as well. No absolute number, magnitude nor density can be defined which holds for every situation. Sometimes, discharges with lower magnitude but higher repetition can be more harmful to the system rather than discharges of higher magnitude with lower repetition rate. Even a quenching PD activity could indicate an approaching fault. This points out the necessity of identifying

This work was supported by KEMA Nederland B.V. and the Dutch utilities N.V. Continuon Netbeheer, ENECO Netbeheer B.V., and Essent Network B.V.

the PD source and the ongoing degradation mechanism. Various insulation mechanisms manifest themselves with specific PD behavior [3]. This section provides a background of these patterns and the applied model.

In on-line measurement, monitoring discharge quantities gives indication of changes in discharge activity [4], but detailed analysis is required on the data from critical locations to identify the source of the discharges. Furthermore, the density versus time pattern is being monitored to see whether changes in trends are observed. Trend variation of the PD density may serve as a warning for an evolving defect or even for an approaching end of life.

A. Partial Discharge Mapping

The PD mapping diagram is a plot of the discharge magnitude versus the length of the cable system. Such plot reveals the critical locations within a cable connection. The critical location is subjected to detailed PD analyses by studying their PD patterns.

B. Pulse Height Analysis

One of the patterns used in the field of diagnostic is the PD height distribution. Different types of PD phenomena produce bursts of pulses with different amplitude distributions [5]. One of the commonly used distributions to model this pattern is the Weibull distribution. Equation (1) and (2) reflect the Weibull density function and the Weibull cumulative distribution function (CDF):

$$f(q; \alpha, \beta) = \frac{\beta}{\alpha} \left(\frac{q}{\alpha}\right)^{\beta-1} \exp\left(-\left(\frac{q}{\alpha}\right)^\beta\right) \quad (1)$$

$$F(q; \alpha, \beta) = 1 - \exp\left(-\left(\frac{q}{\alpha}\right)^\beta\right) \quad (2)$$

where α and β denote the scale and shape parameter respectively, and q is the discharge magnitude.

This model reduces the characteristics of PD's to a few parameters for the activity of a single PD source [6]. If several PD sources occur simultaneously, a higher order model, for instance a 5-parameter Weibull distribution, may provide a better description. The parameters of this model, especially the shape factor, do not only provide reliable markers to identify the nature of the discharge source but also are a good benchmark to assess the degradation of the insulation. The physical justification behind the stochastic behavior of PD phenomena occurring in a certain defect can be understood in terms of factors such as distribution of the space charges, the location where the seed electron appears, the structure of the electron avalanche, etc. [7].

C. Discharge Density vs. Time

One of the main benefits of an on-line measurement system is its ability to measure over long periods of time or even to monitor continuously [8]. The time evolution, the variation of the discharge activity over time, provides complementary

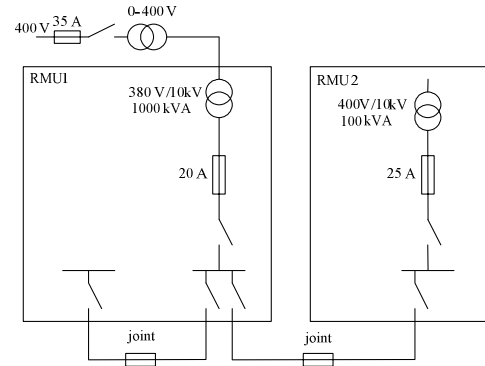

Fig. 1. Test set up for experimental on-line PD measurement [8].

information to the pulse height distribution. It also may serve as an indicator of the aging process as well as for changes that may occur at the PD location. As soon as significant changes are observed the pulse height analysis is carried out to verify whether a modification of the defect has occurred.

IV. EXPERIMENTAL ANALYSIS

A. Test Set-Up

An experiment was run in a small MV grid at KEMA, The Netherlands, for about 7 hours. This set up consists of two main ring units, interconnected by a paper insulated lead covered (PILC) MV cable. The cable consists of two sections connected with an oil-filled joint. A simple electrode-bounded defect was embedded in the joint located at 96 m distance from one RMU. The cable was energized with a 400 V / 10 kV transformer. Figure 1 shows the test set-up for experimental on-line PD measurement. The acquired data were subjected to the pattern analyses.

B. Simulations and Results

During the measurement 397 PD records were stored in a database. Each record includes the data from the measurement over 20 ms (one power cycle) which was performed about every minute. The PD mapping diagram (Fig. 2) was created to identify the suspected location. As one can observe from the diagram, the critical region is located at almost 100 m from the termination, which is indeed the location of the joint.

Discharges originating from the defective joint were extracted and a PHD pattern was created for each measurement. The logarithmic Weibull CDF was fitted to the data. The maximum likelihood approach and Newton-Raphson method were employed to numerically estimate the model parameters.

Figure 3 shows the PD discharge pattern from the defect. According to [9] such asymmetric discharge pattern, where a large number of small discharges followed by a smaller number of larger discharges appears, is typical for internal discharges and, particularly, for electrode-bounded discharges. Figure 4, depicts the pulse height distribution and Weibull fit for the discharges shown in Fig. 3. The bottom half shows the residual of the fit, which indicates that the model fits the discharges well, except for low discharge levels. This is due to

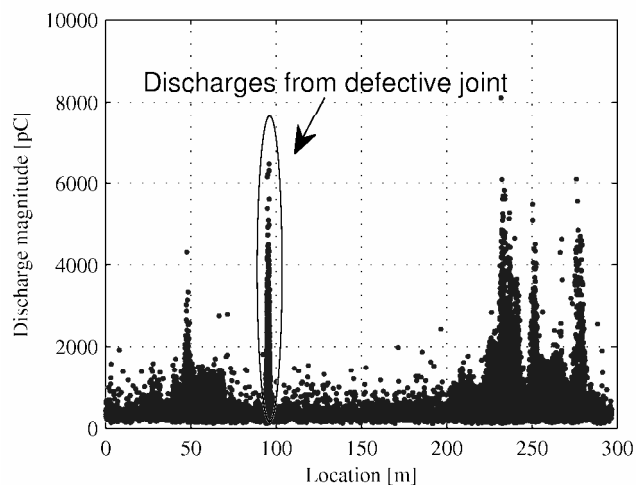

Fig. 2. PD mapping diagram for on-line measurement with test set up.

the starting point of the Weibull plot which poses our model to start from zero, while in the analysis we are restrained by the minimum discharge magnitude which the PD measuring system can detect.

The second pattern studied for the defective joint is the density vs. time plot, shown in Fig. 5. The discharge activity ceased between hours 4:30-5:00. Such behavior can be indicative for a specific defect type. A possible explanation is the formation of a carbon layer on the oil surface which creates a conductive path for the charges to leak preventing further PD activity.

For comparison, a statistical analysis was performed to identify the changes of the PD characteristics just after the non-discharge-activity (Fig. 6). The value of the shape parameter has increased from 2.5 to 4.0. The change in the shape factor could be a warning for ongoing aging of the insulation.

V. FIELD DATA ANALYSIS

Data obtained from the field over a period of 3 months, were analyzed. The PILC cable is suspected to suffer from dry-out-of-paper which is categorized as internal PD activity.

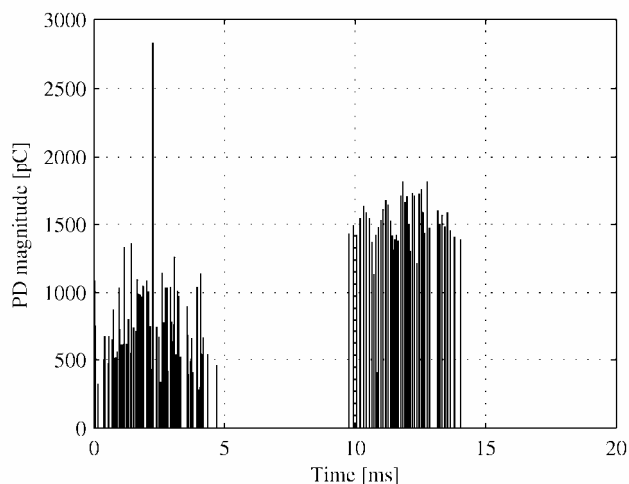

Fig. 3. PD pattern of a single record of a 20 ms measurement; the selected discharges originate from a defective joint located at 96 m.

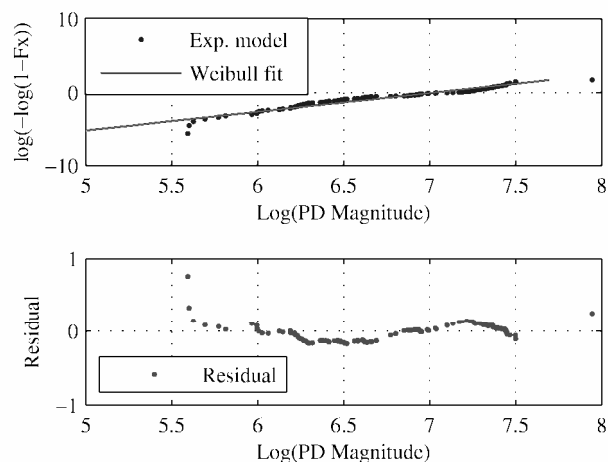

Fig. 4. Weibull fit based on data of a single record of 20 ms originated from a defective joint $\alpha = 1117 pC$ and $\beta = 2.27 \pm 0.15$.

The Weibull analysis was performed on the data set. The value of the shape factor can be indicative for this specific defect, however more practical experience is required for correlating the statistical parameters to the actual degradation mechanism and for risk assessment of the defect.

Figure 7 shows the PD mapping for the discharges from the circuit. A certain part of the cable, shown as “Cluster I”, was selected and was subjected to statistical analysis. Figure 8, shows the result of the Weibull analysis of the chosen cable part. As it can be observed from both fit and residual, except for the low discharge magnitude, the model provides a good fit to the discharge magnitude distribution. Low magnitude PD’s, close to the experimental detection level, are difficult to extract from the measured records and are expected to cause such deviation.

VI. CONCLUSION

The Weibull distribution provides a proper tool to quantify the characteristic of the discharge patterns. It is shown that there is a clear correlation between the value of the shape factor of this model and the origin of the discharges.

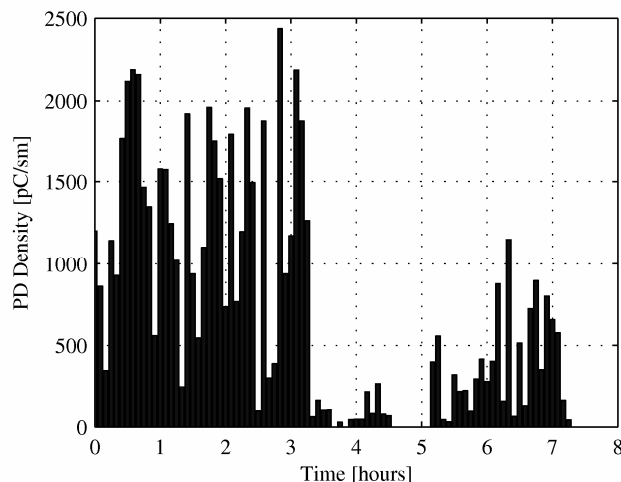

Fig. 5. PD charge density mapping as a function of time for discharges originated from a defective joint.

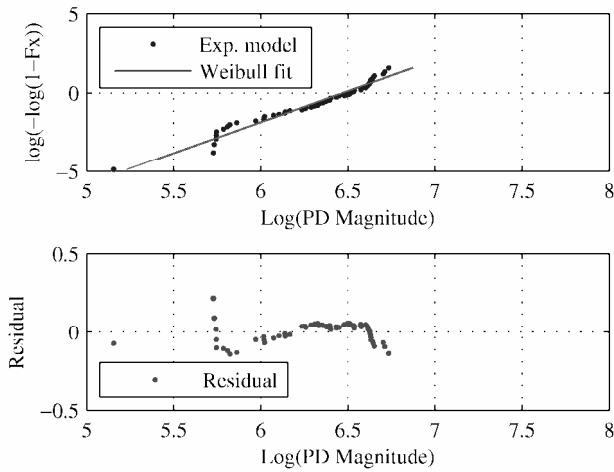

Fig. 6. Weibull fit to data of a single record of 20 ms originated from a defective joint taken past the period of ceased PD activity (see Fig. 5), $\alpha = 645 pC$ and $\beta = 4.39 \pm 0.44$.

Practical experience will grow fast, since many on-line PD (PD-OL) detecting and locating systems are presently already operational, or will be installed in the field shortly. The units are capable of continuously monitoring the system under operating condition as well as locating the discharge source, therefore providing the statistical parameters as a function of time and location, including their variation. The reliability of the Weibull model must be proven by obtaining further practical experience. However, the results up to now seem promising and it is expected that the statistical analysis of the data in combination with other information as PD density will be a step forward in reliable assessment of status of a defect.

A possible concern is the rather poor fit to low discharge magnitudes. This can be omitted by discarding small PD's, which are close to the system detection threshold level. One should, of course, make sure that they are irrelevant to the aging process. The model properly fits to the discharges which originate from a single discharge source. In theory, multiple defects can be active at the same time. Fortunately, owing to

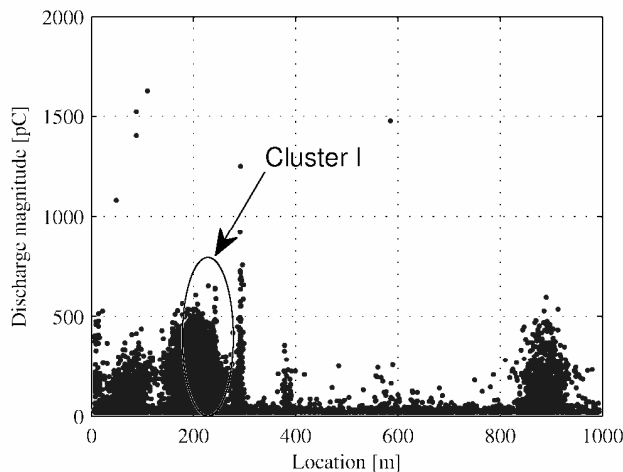

Fig. 7. PD mapping diagram for field data collected over a period of 3 months on-line measurement.

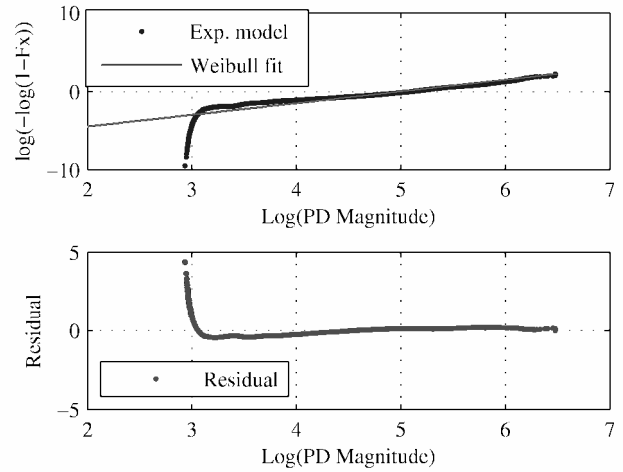

Fig. 8. Weibull fit to field data obtained over a period of 3 months, $\alpha = 145 pC$ and $\beta = 1.29 \pm 0.01$.

the capability of the on-line system being used to accurately locate the PD origin this is unlikely if a narrow region of the cable connection is selected for statistical analysis.

VII. REFERENCES

- [1] B.A. Lloyd, S.R. Campbell, G.C. Stone, "Continuous on-line partial discharge monitoring of generator stator windings," *IEEE trans. On Energy Conversion*, Vol. 14, No. 4, December 1999.
- [2] B. Yazici, "Statistical pattern analysis of partial discharge measurements for quality assessment of insulation systems in high voltage electrical machinery," *IEEE Trans. On industry applications*, Vol. 40, No.6, November/December 2004.
- [3] M. Fenger, G.C. Stone, B.A. Lloyd, "Experience with continuous partial discharge monitoring of stator windings," in *Proc. 2001 IEEE Elec. Insulation Conf. and Elec. Manufacturing and Coil winding*, pp. 417-421.
- [4] C. Hudon and M. Bélec, "The importance of phase resolved partial discharge pattern recognition for on-line generator monitoring," *IEEE Int. Symp. On Elec. Insulation*, June, 1998.
- [5] P.Y. Chia, A.C. Liew, "Defect Classification Based On Weibull statistics of Partial Discharge Height Distribution with Wavelet Processing," in *Proc. 2000 IEEE Power System Technology Int. Conf.*, Vol. 2, pp. 1035-1040.
- [6] M. Cacciari, A. Contin, G. C. Montanari, "Use of a Mixed-Weibull Distribution for the identification of PD phenomena," *IEEE Trans. On Dielectric and Elec. Insulation*, Vol. 2, No.6, December 1995.
- [7] Yicheng Wang, "New method for measuring statistical distributions of partial discharge pulses," *J. Res. Natl. Inst. Stand. Technol.* Vol. 102, pp. 569-576, No. 5, September/ October 1997.
- [8] P.C.J.M van der Wielen "On-line detection and location of Partial discharges in Medium-Voltage Power Cables," PhD dissertation, Dept. Elec. Eng., Univ. Eindhoven, the Netherlands 2005.
- [9] F.H. Kreuger, *Partial Discharge Detection in High-Voltage Equipment*, London: Butterworth & Co., 1989, p. 136.