

## Improved convergence of MRAC design for printing system

**Citation for published version (APA):**

Ezzeldin Mahdy Abdelmonem, M., Bosch, van den, P. P. J., & Waarsing, R. (2009). Improved convergence of MRAC design for printing system. In *Proceedings of the 28th American Control Conference, (ACC '09) 10 - 12 June 2009, St. Louis, MO, USA* (pp. 3232-3237). Institute of Electrical and Electronics Engineers.  
<https://doi.org/10.1109/ACC.2009.5160129>

**DOI:**

[10.1109/ACC.2009.5160129](https://doi.org/10.1109/ACC.2009.5160129)

**Document status and date:**

Published: 01/01/2009

**Document Version:**

Publisher's PDF, also known as Version of Record (includes final page, issue and volume numbers)

**Please check the document version of this publication:**

- A submitted manuscript is the version of the article upon submission and before peer-review. There can be important differences between the submitted version and the official published version of record. People interested in the research are advised to contact the author for the final version of the publication, or visit the DOI to the publisher's website.
- The final author version and the galley proof are versions of the publication after peer review.
- The final published version features the final layout of the paper including the volume, issue and page numbers.

[Link to publication](#)

**General rights**

Copyright and moral rights for the publications made accessible in the public portal are retained by the authors and/or other copyright owners and it is a condition of accessing publications that users recognise and abide by the legal requirements associated with these rights.

- Users may download and print one copy of any publication from the public portal for the purpose of private study or research.
- You may not further distribute the material or use it for any profit-making activity or commercial gain
- You may freely distribute the URL identifying the publication in the public portal.

If the publication is distributed under the terms of Article 25fa of the Dutch Copyright Act, indicated by the "Taverne" license above, please follow below link for the End User Agreement:

[www.tue.nl/taverne](http://www.tue.nl/taverne)

**Take down policy**

If you believe that this document breaches copyright please contact us at:

[openaccess@tue.nl](mailto:openaccess@tue.nl)

providing details and we will investigate your claim.

# Improved Convergence of MRAC Design for Printing System

M. Ezzeldin, P.P.J. van den Bosch, *Member, IEEE*, R. Waarsing

**Abstract**—This paper deals with the improved design of stable model reference adaptive systems, by introducing a nonlinear adaptation gain. Uniform asymptotic stability of the system is demonstrated for both state and output feedback cases. A simulation example shows the effectiveness of the proposed approach when large parameter variations and disturbances are active. It is also being applied to control a real printing system.

**Keywords** — adaptation gain, model reference adaptive control, Lyapunov function, printing systems.

## I. INTRODUCTION

IN adaptive control the controlled system monitors its performance and makes adjustments to improve that performance [1-6]. Model reference adaptive control (MRAC) is an example of an implicit adaptive controller. MRAC was first introduced by Whitacker in 1958. A block diagram of MRAC system is shown in figure 1. It can be regarded as an adaptive servo system in which the desired performance is expressed in terms of a reference model, which represents the desired response to a command signal. An adaptation mechanism keeps track of the process output  $y_p$  and the reference model output  $y_m$  and calculates a suitable parameter setting such that the difference between these outputs tends to zero. An important issue in MRAC is the design of the adaptive law. The adaptive law designs made first use of sensitivity models and later were based on the stability theory of Lyapunov and Popov's hyperstability theory. These approaches are described in [7] and [8].

The adaptation gain  $\Gamma$  determines the rate at which the controller parameter will converge to the correct parameters. Moreover, the adaptation gain influences the performance of the system. Hence, the adaptation gain should be properly chosen. A too high adaptation gain may lead to badly damped behavior while a too low adaptation gain will lead to an unaccepted slow response. Some methods are introduced in [6] to determine the adaptation gain. Two algorithms to tune the adaptation gain for a gradient based

parameter update law used for a class of nonlinear discrete-time systems are proposed in [3]. These algorithms depend on the knowledge of the system model and the system states. Moreover, it requires a lot of online computation time. In [5-11] the adaptation gain is constant. We propose a nonlinear varying adaptation gain and do not require any knowledge of the parameters of the system. To improve the system performance, the adaptation gain could be chosen as a function of the controller parameters error. Unfortunately, the correct controller parameters depend on the process parameters which are usually unknown. However, the error between the outputs of the process and of the reference model gives also a good indication of the controller parameters error. Hence, we propose an adaptation gain as a function of the output error instead of controller parameters error. A new Lyapunov function is introduced to investigate the stability of both state and output feedback MRAC systems. A simulation example is given to illustrate the effectiveness of the proposed approach.

In a printing system there are many challenging problems e.g. large changes in paper weight, humidity, speed, printing accuracy, etc. In this paper MRAC with a nonlinear adaptation gain is proposed to control a printing system.

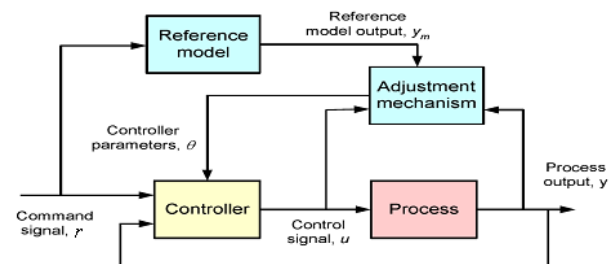

Fig. 1 Main structure of MRAC

## II. MODIFIED STATE FEEDBACK MRAC

This section presents a MRAC design for processes with state feedback. We start with reviewing the state feedback MRAC design, then a modified design of MRAC is proposed based on a variable adaptation gain.

### A. MRAC State Feedback Review [6]

Consider a SISO linear system described by

<sup>1</sup>This work has been carried out as part of the OCTOPUS project with Océ Technologies B.V. under the responsibility of the Embedded Systems Institute. This project is partially supported by the Netherlands Ministry of Economic Affairs under the Bsik program.

M. Ezzeldin and P.P.J. van den Bosch are with the Department of Electrical Engineering, Eindhoven University of Technology, P.O. Box 513, 5600 MB Eindhoven, Netherlands. E-mail: [m.ezz@tue.nl](mailto:m.ezz@tue.nl), [p.p.j.v.d.bosch@tue.nl](mailto:p.p.j.v.d.bosch@tue.nl). R. Waarsing is with Océ-Technologies B.V. E-mail: [rene.waarsing@oce.com](mailto:rene.waarsing@oce.com)

$$\dot{x}_p = A_p x_p + B_p u \quad (1)$$

where  $x_p \in R^n$  is the process state vector,  $y_p$  is the process output,  $A_p \in R^{n \times n}$ ,  $B_p \in R^n$  are system matrices and  $u$  is the process input. Consider a stable reference model given by

$$\dot{x}_m = A_m x_m + B_m r \quad (2)$$

Assume that both models are represented in the controller canonical forms, with  $B_m = [0 \ \dots \ 0 \ 1]^T$  and  $r \in R$ .

Consider the state feedback control law  $u = k_0 r + k_b^T x_p$

which can be written as  $u = \theta^T w$  (3)

with  $\theta^T = [k_0 \ k_b^T] \in R^{n+1}$  are the controller parameters

and  $w^T = [r \ x_p^T] \in R^{n+1}$ . Hence, the close loop system

becomes  $\dot{x}_p = (A_p + B_p k_b^T) x_p + B_p k_0 r = A_c(\theta) x_p + B_c(\theta) r$

select error  $e = x_p - x_m$ , so

$$\dot{e} = A_m e + (A_c(\theta) - A_m) x_p + (B_c(\theta) - B_m) r$$

Hence, the error derivative becomes

$$\dot{e} = A_m e + b_I \Phi^T w \quad (4)$$

where  $\Phi = \theta - \theta_m$  is the difference between the parameters of the controlled system and of the model, and  $b_I = (0 \ \dots \ 0 \ 1)^T$

By selecting a Lyapunov function  $V = e^T P e + \Phi^T \Gamma^{-1} \Phi$  the adaptation law is

$$\dot{\Phi} = \dot{\theta} = -\Gamma e^T P b_I w \quad (5)$$

with  $\Gamma$  a constant positive adaptation gain and  $P$  a positive definite matrix yields  $\dot{V} = e^T (A_m^T P + P A_m) e < 0$

Equation (5) provides a stable adaptive system. The choice of the adaptation gain  $\Gamma$  could be crucial for the performance. To improve the system performance, the adaptation gain should be properly chosen.

### B. MRAC Design with a Nonlinear Adaptation Gain

In this subsection a new MRAC state feedback design is introduced based on a nonlinear adaptation gain.  $\Gamma$  is a function of the error  $e$  such that if the error is high,  $\Gamma$  will be large which means that the controller will adapt its parameters faster and faster error convergence can be obtained. Let the adaptation gain be

$$\Gamma = \gamma_0 + \gamma_1 e^T P e, \gamma_0 > 0, \gamma_1 > 0, P > 0, \text{ so } \Gamma > 0 \quad (6)$$

Now equation (5) with the adaptation gain as defined in (6) yields an adaptive law which provides a stable adaptive system.

**Lemma 1** Using the control law (3), the adaptation law (5) and the nonlinear adaptation gain (6), the closed loop system is asymptotically stable.

**Proof**

The candidate Lyapunov function is

$$V = \left(\frac{\gamma_1}{2} e^T P e + \gamma_0\right) e^T P e + \Phi^T \Phi \quad (7)$$

where  $\gamma_0 > 0, \gamma_1 > 0$ , and  $P$  is a positive definite symmetric matrix. The time derivative of  $V$  will be

$$\dot{V} = \left(\frac{\gamma_1}{2} e^T P e + \gamma_0\right) (\dot{e}^T P e + e^T P \dot{e}) \quad (8)$$

$$+ \frac{\gamma_1}{2} (\dot{e}^T P e + e^T P \dot{e}) e^T P e + 2\Phi^T \dot{\Phi}$$

$$\dot{V} = (\gamma_1 e^T P e + \gamma_0) (\dot{e}^T P e + e^T P \dot{e}) + 2\Phi^T \dot{\Phi} \quad (9)$$

Using the error equation defined in (4) and adaptation gain defined in (6), the time derivative of  $V$  yields

$$\dot{V} = \Gamma (e^T (A_m^T P + P A_m) e + 2e^T P b_I \Phi^T w) + 2\Phi^T \dot{\Phi} \quad (10)$$

Let the adaptation law be  $\dot{\Phi} = \dot{\theta} = -\Gamma e^T P b_I w$

then  $\dot{V} = \Gamma e^T (A_m^T P + P A_m) e < 0$  if  $e^T e \neq 0$  □

**Remark:**

Both  $\gamma_0$  and  $\gamma_1$  are scalar design parameters. The nonlinear adaptation gain (6) is more generic since the constant adaptation gain can be retrieved by choosing  $\gamma_1 = 0$ .

### III. OUTPUT FEEDBACK MRAC WITH A NONLINEAR ADAPTATION GAIN

In practice, limited state information may be available, and only the process output may be measurable. A state reconstruction in such a case, for example by means of a Kalman-filter type of observer, is difficult because of the unknown process parameters. Several methods have been proposed for designing MRAC when using output feedback [5;11;12]

One of these methods is known as ‘‘augmented error method’’. The augmented error method is a combination of a primary controller and a set of adaptive laws. The primary controller of the augmented error method is shown in figure

2, which indicates that two auxiliary signal generators (ASGs) produce vectors  $w_1$  and  $w_2$ , with  $w_i \in R^{n-1}$ . The design of the ASGs is described in [7]. If the reference model is

$$\begin{aligned}\dot{x}_m &= A_m x_m + B_m r \\ y_m &= C_m x_m\end{aligned}$$

then it was shown in [5] that the output error  $e_1 = y_p - y_m$  can be written as  $e_1 = G_m(\Phi^T w)$  where  $w^T = [r \ w_1^T \ y_p \ w_2^T]$ ,  $\Phi = \theta - \theta_m$  is the parameter error vector,  $\theta^T = [k_0 \ f^T \ k_1 \ d^T]$ , and  $G_m = C_m(sI - A_m)^{-1} B_m$  represents the reference model. The control law can be written as  $u = \theta^T w$  (11) The error equation is

$$\dot{e} = A_m e + B_m(\Phi^T w) \quad (12)$$

where  $e(t) = [e_1 \ \dot{e}_1 \ \dots \ e_1^{(n-1)}]^T$

Assume that  $G_m$  is strictly positive real (SPR) and is represented in controller canonical form. So there exist  $P > 0$ ,  $Q > 0$  such that

$$\begin{aligned}A_m^T P + P A_m &= -Q, \\ P B_m &= C_m^T.\end{aligned} \quad (13)$$

By applying Lyapunov stability with the error equation (12) and the SPR property (13), it is found in [7] that the adaptation law will be  $\dot{\Phi} = \dot{\theta} = -\Gamma e_1 w$  (14) where  $\Gamma$  is a constant adaptation gain. Again, to improve the system behavior, a nonlinear adaptation gain is considered.

**Lemma 2** Using the control law (11), the adaptation law (14) and the nonlinear adaptation gain (6), the closed loop system is asymptotically stable.

### Proof

Consider the adaptation gain  $\Gamma$  (6) and the candidate Lyapunov function  $V$  (7). The time derivative of  $V$  will be

$$\begin{aligned}\dot{V} &= \left(\frac{\gamma_1}{2} e^T P e + \gamma_0\right)(\dot{e}^T P e + e^T P \dot{e}) \\ &+ \frac{\gamma_1}{2} (\dot{e}^T P e + e^T P \dot{e}) e^T P e + 2\Phi^T \dot{\Phi} \\ \dot{V} &= (\gamma_1 e^T P e + \gamma_0)(\dot{e}^T P e + e^T P \dot{e}) + 2\Phi^T \dot{\Phi}\end{aligned}$$

With (12):

$$\dot{V} = \Gamma(e^T (A_m^T P + P A_m)e + 2B_m^T P e(\Phi^T w)) + 2\Phi^T \dot{\Phi}$$

Applying SPR property (13)

$$\dot{V} = \Gamma(e^T (-Q)e + 2e_1(\Phi^T w)) + 2\Phi^T \dot{\Phi}$$

Let the adaptation law be  $\dot{\Phi} = -\Gamma e_1 w$

then,  $\dot{V} = \Gamma e^T (-Q)e < 0$  if  $e^T e \neq 0$ , with  $\Gamma$  defined in (6).  $\square$

### Remark:

In case that  $G_m$  is not strictly positive real, it is necessary to add zeros to the error equation (12). This is achieved by adding an extra signal to the output error. The augmented error signal will be  $\varepsilon = e_1 + v$ . A detailed procedure for choosing  $v$  can be found in [7]. The error equation will be

$$\dot{e} = A_m e + B_m' \Phi^T (L^{-1} w) \quad (15)$$

where,  $L$  is a design polynomial in the Laplace operator ( $s$ ), which is chosen such that the product  $L G_m$  is SPR, and

$$e = [\varepsilon \ \dot{\varepsilon} \ \dots \ \varepsilon^{(n-1)}]^T \quad (16)$$

The adaptation law will depend on the augmented error instead of output error. Moreover, the adaptation gain will be a function of the augmented error. Using Lyapunov function (7) and the error equation (15) the adaptation law will be  $\dot{\theta} = -\Gamma(L^{-1} w)\varepsilon$ , with  $\Gamma$  defined in (6) and  $e$  defined in (16). The stability proof is straight forward.

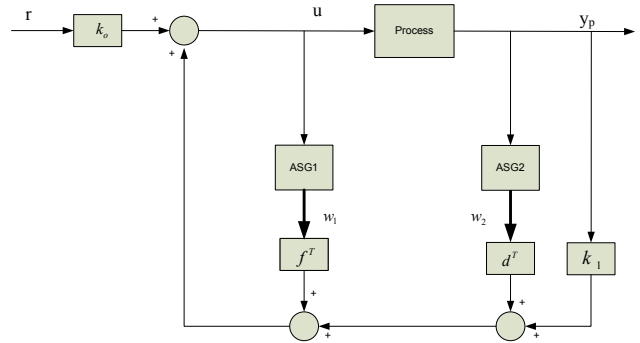

Fig. 2 Primary controller structure of augmented error method

## IV. COMPARISON EXAMPLE

This section presents a comparison example to compare the effectiveness of the nonlinear adaptation gain with a constant gain. Consider a second order process [7]

$$G_p = \frac{12}{s^2 + 2s + 8}$$

and a reference model

$$G_m = \frac{16}{s^2 + 8s + 16}$$

The objective is to design an adaptive controller such that the closed loop system behaves as the reference model. Two design cases are considered

1. State feedback MRAC

In this case, we assume that all the states are measurable. The controller is constructed using control law (3) and adaptive law (5). Figure 3 and 4 show the states responses and the states tracking error for nonlinear and constant adaptation gain. It is clear that using the nonlinear adaptation gain (6) the convergence speed increases considerably.

2. Output feedback MRAC

In this case, only the output is measured, applying the augmented error method with the primary control structure shown in figure 2 and the adaptive laws with constant and nonlinear adaptation gain. Figure 5 shows the system response in case of output feedback MRAC for both nonlinear and constant adaptation gain. The adaptation (implicit identification) phase is much shorter.

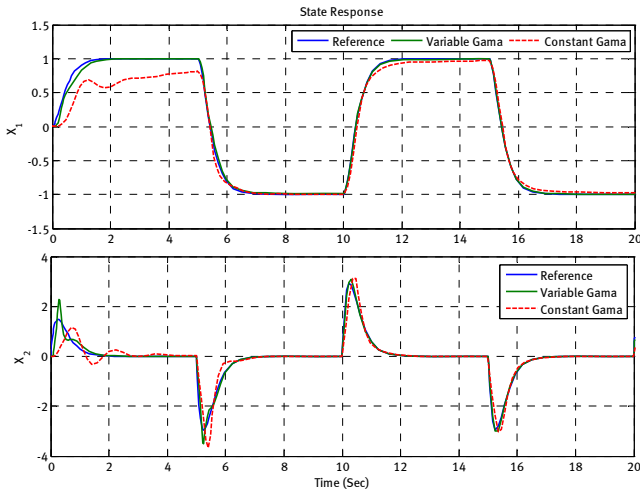

Fig. 3 State feedback for fixed and variable adaptation gain

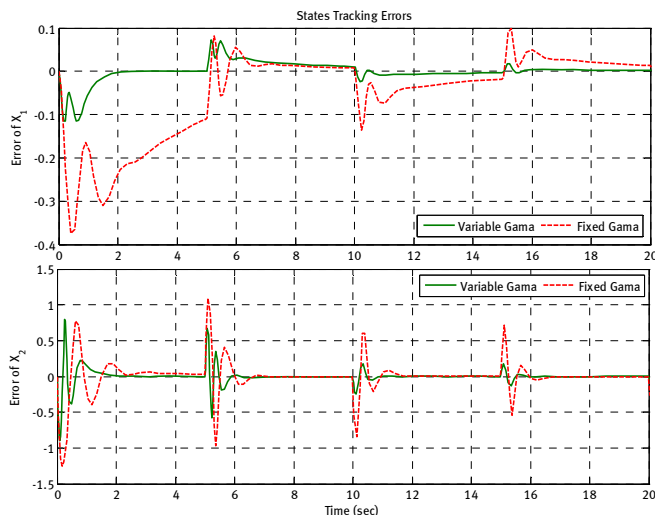

Fig. 4 State tracking error

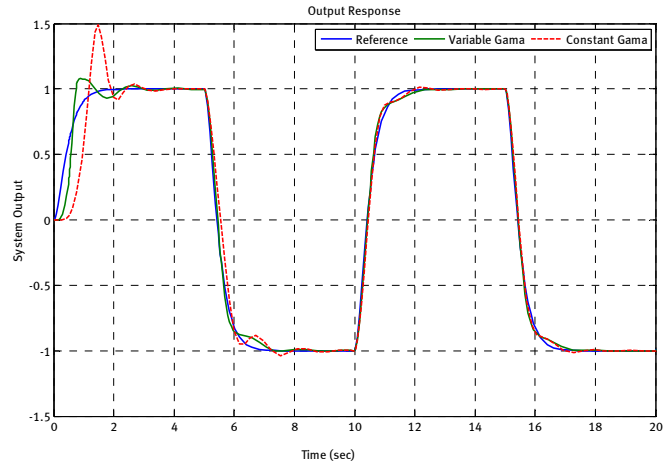

Fig. 5 Output feedback for fixed and variable adaptation gain

V. APPLICATION OF MRAC FOR PRINTING SYSTEM

In this section, MRAC with a nonlinear adaptation gain is applied to a laser printer. This section starts with describing the printing process, modeling of the system and finally showing some simulation results.

A. Printing system description

The laser printer mainly consists of several subsystems; e.g. a preheating system, an imaging unit, a toner transfer belt system and a drive system. The schematic representation of the system is shown in figure 6.

In the preheating system, the paper is heated to a certain temperature before it reaches the fusing pinch. The imaging unit is used to produce the toner image. The transfer belt system is responsible for transporting the toner from the imaging unit to the fusing nip where the toner is fused on the paper. The drive system determines the speed of the transfer belt which affects the productivity of the printing process, but limited power sources and high mass media are the limitations for the productivity. It is necessary to control and monitor the fuse temperature accurately because if the fuse temperature is too low, the toner will not penetrate the paper accurately and it will stick on the top of the paper, whereas if the fuse temperature is too high, the toner will melt and stick to any other surfaces.

Important problems in the printing system are the varying time delay (depending on paper speed), changing parameters (paper size, weight, and humidity) and nonlinearities. These problems will influence the stability and performance of the closed-loop system. An adaptive control algorithm is a proper choice. The objective is to design a controller which can keep both the printing quality and the productivity as good as possible. Good quality means that the fusing

temperature should track a reference signal at all operating conditions. Based on the system behavior, the MRAC algorithm with a nonlinear adaptation gain is suggested.

### B. System modeling

The system is divided into two subsystems:

#### 1. Preheating system

The preheating system can be described by the following state space representation.

$$\dot{T}_{pre} = A(m, v)T_{pre} + \frac{1}{C_{pre}}P_{pre} + \Omega,$$

$$y = T_{pre}$$

where  $A(m, v)$  is the system pole which is function of the paper mass ( $m$ ) and the drive speed ( $v$ ),  $\Omega$  is an uncertainty term of the system,  $P_{pre}$  is the heating power and  $C_{pre}$  is the thermal capacity.

#### 2. Fusing system.

The fuse temperature cannot be measured from the transfer belt. An estimation formula is used to estimate the fuse temperature. The fusing system can be described by a third order linear model with state noise. Due to industrial confidential reasons, the fusing model is omitted.

### C. Simulation results

The most widely used industrial controller today is still the PID controller. PID controller is simple, easy to implement, and requires no accurate process model. But PID controller also has some shortcomings. Since PI controller is currently used in the printing system, this subsection presents a comparison of the tracking results of the MRAC with a nonlinear adaptation gain and PI controller. To have a fair comparison, the PI controller is well tuned first. To simulate the parameter uncertainty, the paper mass and the drive speed are changed during the simulation. Figure 7 indicates the fusing temperature tracking error comparison. It is clear that the tracking performance of the MRAC is much better than that of the PI controller. Figure 8 shows the preheating temperature comparison in case of paper mass variations. In case of large paper mass, a sudden reduction in the preheating temperature happens and the MRAC can manage to track the desired temperature faster than the PI controller. The variation in the paper mass is depicted in figure 9. This simulation example shows that the MRAC with a nonlinear adaptation gain can handle the system efficiently in the presence of parameters with large variations.

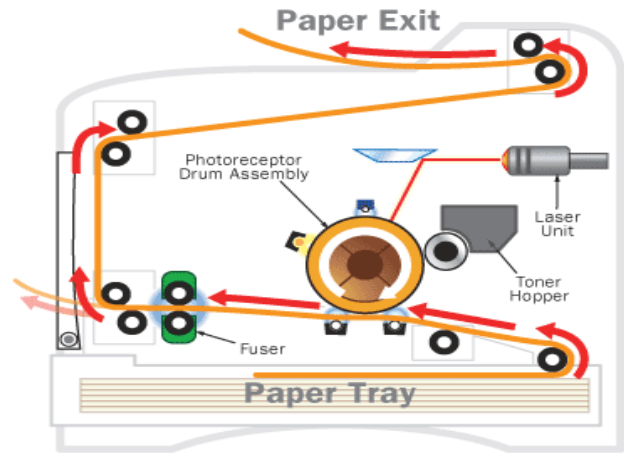

Fig. 6 Schematic diagram of printing system

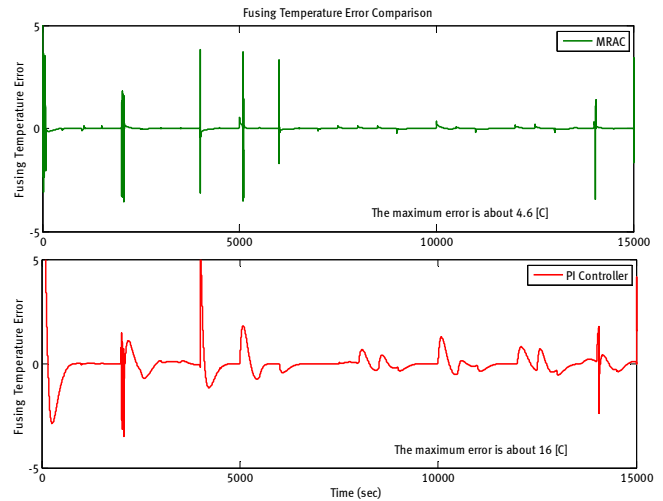

Fig. 7 Error fuse temperature

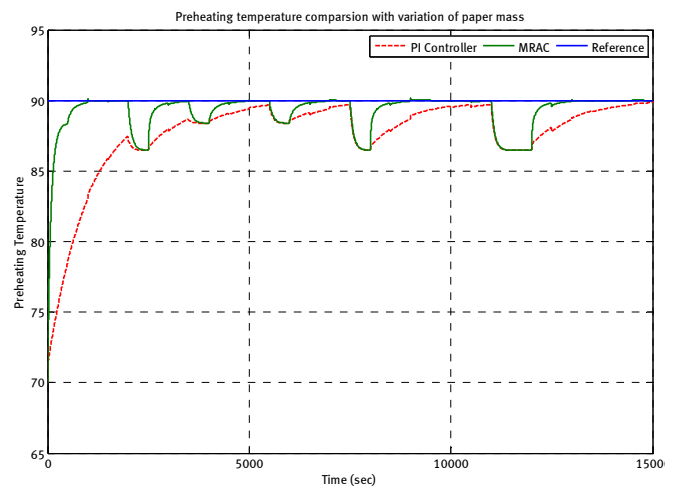

Fig. 8 Comparison of preheating temperature in case of variation of paper mass

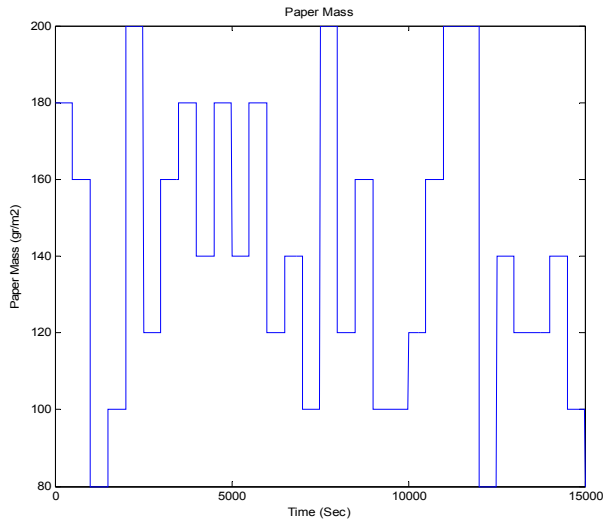

Fig. 9 Variation of the paper mass

## VI. CONCLUSION

This paper proposed MRAC with a nonlinear varying adaptation gain. The adaptation gain has been chosen to be a function of the error to speed up the adaptation process when the error is large. The proposed design yields a faster error convergence for both state and output feedback compared with a constant adaptation gain. A new Lyapunov function has been introduced to prove the stability of the system when applying the proposed MRAC. The proposed MRAC is used to control a printing system. Simulations with the printing system illustrated the effectiveness of the technique. A good tracking and robust stability has been obtained in large parameters variations.

## Reference

- [1] M. A. L. Thathachar and F. Gajendran. Convergence problems in a class of model reference adaptive control systems. *Proceedings of the IEEE Conference on Decision and Control*. New Orleans, LA, USA. 1036-1041. 1977.
- [2] M. Takahashi, I. Mizumoto, and Z. Iwai, "Adaptive output feedback control system design for MIMO plants with unknown plant orders," *Transactions of the Society of Instrument and Control Engineers*, vol. 33, no. 5, pp. 359-367, 1997.
- [3] H. N. Nounou and K. M. Passino. Stable auto-tuning of the adaptation gain for direct adaptive control. *Proceedings of American Control Conference*, Chicago, IL, USA. 2154-2158. 2000.
- [4] H. N. Nounou and K. M. Passino. Stable auto-tuning of the adaptation gain for continuous-time nonlinear systems. *Proceedings of 40th Conference on Decision and Control*. Orlando, FL, USA. 2037-2042. 2001.

- [5] K. S. Narendra and L. S. Valavani, "Stable adaptive controller design-direct control," *IEEE Transactions on Automatic Control*, vol. AC-23, no. 4, pp. 570-583, 1978.
- [6] K. J. Astrom and B. wittenmark, *Adaptive Control*, 2nd ed. Addison- Wesley, 1995.
- [7] H. Butler, *Model Reference Adaptive Control From Theory to Practice* Prentice Hall International, 1992.
- [8] Z. Chuan and J. E. Fagan. Model reference adaptive control system hyperstability analysis. *25th Southeastern Symposium on System Theory*. Tuscaloosa, AL, USA. 307-309. 1993.
- [9] T. Suzuki and S. Takashima, "A hyperstable scheme for discrete model reference adaptive control system," *International Journal of Control*, vol. 28, no. 2, pp. 245-252, 1978.
- [10] T. Suzuki and Y. Dohimoto, "A modified scheme for the model reference adaptive control with augmented error signal," *International Journal of Control*, vol. 27, no. 2, pp. 199-211, 1978.
- [11] I. D. Landau and H. M. Silveira, "A stability theorem with applications to adaptive control," *IEEE Transactions on Automatic Control*, vol. AC-24, no. 2, pp. 305-312, 1979.
- [12] R. V. Monopoli, "Model reference adaptive control with an augmented error signal," *IEEE Transactions on Automatic Control*, vol. AC-19, no. 5, pp. 474-484, 1974.