

Process mining using BPMN : relating event logs and process models

Citation for published version (APA):

Kalenkova, A. A., Aalst, van der, W. M. P., Lomazova, I. A., & Rubin, V. A. (2015). *Process mining using BPMN : relating event logs and process models*. (BPM reports; Vol. 1501). BPMcenter. org.

Document status and date:

Published: 01/01/2015

Document Version:

Publisher's PDF, also known as Version of Record (includes final page, issue and volume numbers)

Please check the document version of this publication:

- A submitted manuscript is the version of the article upon submission and before peer-review. There can be important differences between the submitted version and the official published version of record. People interested in the research are advised to contact the author for the final version of the publication, or visit the DOI to the publisher's website.
- The final author version and the galley proof are versions of the publication after peer review.
- The final published version features the final layout of the paper including the volume, issue and page numbers.

[Link to publication](#)

General rights

Copyright and moral rights for the publications made accessible in the public portal are retained by the authors and/or other copyright owners and it is a condition of accessing publications that users recognise and abide by the legal requirements associated with these rights.

- Users may download and print one copy of any publication from the public portal for the purpose of private study or research.
- You may not further distribute the material or use it for any profit-making activity or commercial gain
- You may freely distribute the URL identifying the publication in the public portal.

If the publication is distributed under the terms of Article 25fa of the Dutch Copyright Act, indicated by the "Taverne" license above, please follow below link for the End User Agreement:

www.tue.nl/taverne

Take down policy

If you believe that this document breaches copyright please contact us at:

openaccess@tue.nl

providing details and we will investigate your claim.

Process Mining Using BPMN: Relating Event Logs and Process Models

Anna A. Kalenkova · W. M. P. van der Aalst · Irina A. Lomazova ·
Vladimir A. Rubin

Received: 03.2015 / Accepted: date

Abstract Process-aware information systems (PAIS) are systems relying on processes, which involve human and software resources to achieve concrete goals. There is a need to develop approaches for modeling, analysis, improvement and monitoring processes within PAIS. These approaches include process mining techniques used to discover process models from event logs, find log and model deviations, and analyze performance characteristics of processes. The representational bias (a way to model processes) plays an important role in process mining. The BPMN 2.0 (Business Process Model and Notation) standard is widely used and allows to build conventional and understandable process models. In addition to the flat control flow perspective, subprocesses, data flows, resources can be integrated within one BPMN diagram. This makes BPMN very attractive for both process miners and business users. In this paper, we describe and justify robust control flow conversion algorithms, which provide the basis for more advanced BPMN-based discov-

This work is supported by the Basic Research Program of the National Research University Higher School of Economics.

Anna A. Kalenkova · Irina A. Lomazova · Vladimir A. Rubin
National Research University Higher School of Economics, Moscow,
Russia
E-mail: akalenkova@hse.ru

W. M. P. van der Aalst
Department of Mathematics and Computer Science, Eindhoven
University of Technology, Eindhoven, The Netherlands
Business Process Management Discipline, Queensland University of
Technology, Brisbane, Australia
E-mail: w.m.p.v.d.aalst@tue.nl

Irina A. Lomazova
E-mail: ilomazova@hse.ru

Vladimir A. Rubin
E-mail: vrubin@hse.ru

ery and conformance checking algorithms. We believe that the results presented in this paper can be used for a wide variety of BPMN mining and conformance checking algorithms. We also provide metrics for the processes discovered before and after the conversion to BPMN structures. Cases for which conversion algorithms produce more compact or more involved BPMN models in comparison with the initial models are identified.

Keywords Process mining · Process discovery · Conformance checking · BPMN (Business Process Model and Notation) · Petri nets · Bisimulation

1 Introduction

Process-aware information systems (PAIS) are the systems designed to manage processes, operating in various domains of human activity. There is a natural requirement to monitor their work and analyze executed processes. For that purpose one of the promising approaches - *process mining* can be applied.

Process mining is a discipline connecting data mining and process modeling approaches. Process mining offers techniques for automatic discovery of *process models* from event logs, checking compatibility of process models and event logs (conformance checking) and enhancing discovered processes with additional data [4, 5]. Process mining has been successfully applied in a variety of *application domains* such as healthcare, transportation, tourism and education. There is a IEEE process mining community, including more than 60 organizations [21]. Moreover, there is a wide range of *research and commercial tools* available in this area: ProM [35], Disco (Fluxicon), ARIS Process Performance Manager (Software AG), Perceptive Process Mining (Perceptive Software), ProcessAnalyzer (QPR) and Celonis.

Case ID	Event	Timestamp	Price	Client IP
1	book flight	2014-12-24 08:30:00:232	145	188.44.42.45
1	get insurance	2014-12-24 08:31:05:171	23	188.44.42.45
2	book flight	2014-12-24 08:31:08:543	94	93.180.0.62
1	book hotel	2014-12-24 08:32:08:703	295	188.44.42.45
3	book flight	2014-12-24 08:32:11:534	192	188.44.50.103
1	pay	2014-12-24 08:34:17:456	463	188.44.42.45
1	confirm	2014-12-24 08:35:17:537	463	188.44.42.45
...

Table 1: An event log of a booking process.

Today, BPMN 2.0 (Business Process Model and Notation) [30] is the de facto *standard notation* for modeling business processes understandable by a wide audience of people. Business analysts and product managers, technical designers and developers, system and enterprise architects effectively use this notation in their everyday job almost everywhere where BPM is applied. An absolute majority of *freeware and commercial BPM tools* and Business Suites, like Oracle BPM Suite, IBM Business Process Manager, jBPM, Activiti, Appian BPM Suite, Bizagi BPM Suite, MagicDraw Enterprise Architect (Sparx), Mega Process (MEGA), Signavio Process Editor and others, either natively support BPMN or provide conversion in order to stay compatible and up to date.

The *representational bias* used for process mining is not only relevant for the understandability of the results: it is also vital to guide process discovery by setting a suitable class of target models. Using the *BPMN notation as a representational bias within process mining* opens excellent perspectives for applicability of process mining: discovered process models become available and *understandable* by the majority of users, the models can be *imported/exported* from/to any BPMN-aware modeling tool and executed, process mining techniques can be easily *integrated* to the existing suites (BPMN serves as an interface in this case). Moreover, BPMN models allow for the combination of *different perspectives* varying from control flow to the perspective of resources, thus a holistic view on a process model can be obtained.

In this paper we present methods for discovering the *control flow perspective of a process in terms of BPMN*. It should be noted that process mining offers *plenty of algorithms* for the control flow discovery, each of them has its own characteristics. *The goal is not to invent new algorithms, but to benefit from the existing ones and to make them BPMN-compatible*. Thus the discovery of the control flow relies on *conversion algorithms* and *existing process mining techniques*. To that end we firstly formalize the *semantics* for a subset of BPMN models and then present the conversion algorithms from well-known control flow modeling formalisms such as *Petri nets* (including non-free-choice

Petri nets), *causal nets* [6] and *process trees* [8] to BPMN. The conversion algorithms presented in the paper are also given the *justifications* in order to show that behavioral properties of process models discovered from an event log are preserved. Moreover, we show relations between languages of Petri nets and corresponding BPMN models, tacking into account properties of the initial Petri nets.

As a short introductory example, let us consider an event log reflecting a small portion of the history of a ticket booking process, which is presented in Tab. 1. In this process, people use a web site to book a flight, a hotel, get insurance and pay for the ticket. Different people in different cases execute these activities in a different order.

Beside case identifiers, event names, and timestamps, an event log can contain additional event properties, such as costs and resources (participants of the process), in this example they are represented by prices and clients ip addresses (Tab. 1).

To discover a control flow an event log is represented as a multiset of traces, each of which is a sequence of events, corresponding to a concrete case identifier:

$$L = [\langle \text{book flight}, \text{get insurance}, \text{book hotel}, \text{pay}, \text{confirm} \rangle^5, \\ \langle \text{book flight}, \text{book hotel}, \text{get insurance}, \text{pay}, \text{confirm} \rangle^4, \\ \langle \text{book hotel}, \text{book flight}, \text{get insurance}, \text{pay}, \text{confirm} \rangle^4, \\ \langle \text{book hotel}, \text{get insurance}, \text{book flight}, \text{pay}, \text{confirm} \rangle^3, \\ \langle \text{get insurance}, \text{book hotel}, \text{book flight}, \text{pay}, \text{confirm} \rangle^1, \\ \langle \text{get insurance}, \text{book flight}, \text{book hotel}, \text{pay}, \text{confirm} \rangle^1].$$

A *Petri net* discovered from L by the Alpha mining algorithm [10] is presented in Fig. 1.

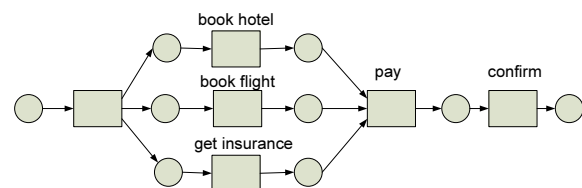

Fig. 1: A Petri net constructed from the log

With the help of a conversion algorithm, we construct a *BPMN model* from the Petri net, as shown in Fig. 2. This BPMN model is more compact than the initial Petri net. Thus, the result of process mining is available in a BPMN notation now; this BPMN model can be easily imported and executed by any of BPM tools mentioned above.

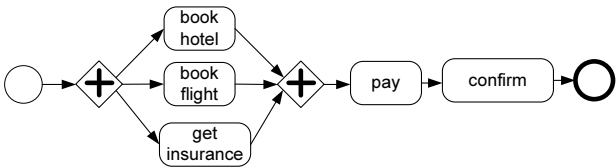

Fig. 2: A BPMN model obtained by a conversion from the Petri net

In order to estimate the advantages of using the BPMN notation for mining, we additionally *compare the complexity* of the models produced by the existing control flow discovery algorithms and the complexity of the corresponding BPMN models. We use the various metrics, such as the number of nodes, density, and diameter [34] for this evaluation. We present not only theoretical but also practical evaluations based on real-life event logs. Moreover, applied to these event logs, the metrics of the discovered BPMN models are compared to the metrics of the models designed manually with a BPMN-editor. This helps us to understand structural differences between models, which are created by process analysts and models discovered from event logs.

Since not only discovery, but also *conformance checking* and *process enhancement* are essential steps in process mining, this paper also shows how to enable them for BPMN models. A BPMN model is converted to a Petri net and then replay techniques are applied [7] to retrieve performance and conformance information. This information is used to enhance BPMN models. Theoretical observations presented in this paper help us to relate states of a BPMN model with the states of a corresponding Petri net. Thus, both conformance and performance information obtained for a Petri net can be visualized using the initial BPMN model.

A general scheme of using BPMN for process mining is presented in Fig. 3. The user discovers a BPMN model by applying discovery and BPMN conversions plugins. To show performance and conformance information and to annotate the BPMN diagram the BPMN model is converted to a Petri net, such that replay techniques can be used.

The paper is organized as follows. *Section 2* introduces basic definitions and notions, including traces, Petri nets, system nets, (weak) simulation and (weak) bisimulation relations. In *Section 3* we propose algorithms for conversion from well-known formalisms such as Petri nets to BPMN and prove correctness of these conversions. In *Section 4*

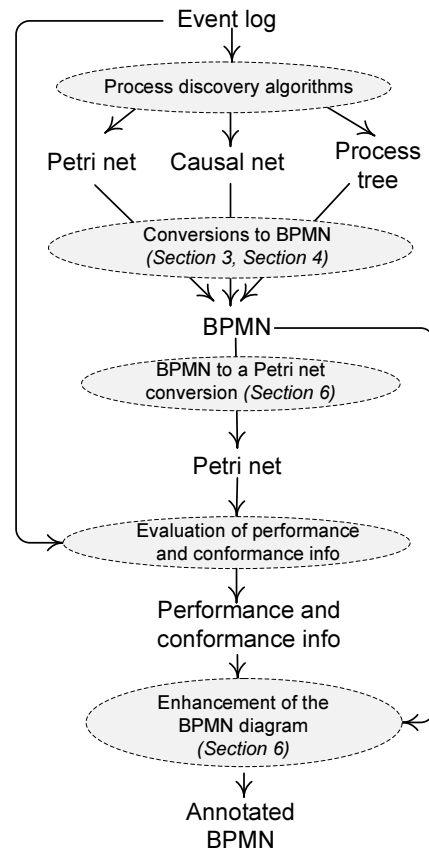

Fig. 3: A general scheme of using BPMN for process mining

transformations of causal nets and process trees to BPMN are introduced. *Section 5* contains a set of BPMN simplification rules. In *Section 6* a technique for conformance checking and performance analysis on the basis of BPMN models is presented. A tool, which implements the proposed conversion and enhancement techniques, is presented in *Section 7*. *Section 8* includes a *case study*, which shows the results of an application of the algorithms presented in the paper to real-life event logs. Also the structural business-processes metrics are calculated and presented in this section. *Section 9* concludes the paper.

2 Preliminaries

In this section we introduce basic notions, event logs, Petri nets, system nets and BPMN semantics.

Multisets are used to present states of Petri nets and BPMN models, also they are used to define event logs, in which one trace can appear multiple times.

$\mathcal{B}(A)$ is the set of all multisets over some set A . For some multiset $b \in \mathcal{B}(A)$, $b(a)$ denotes the number of times element $a \in A$ appears in b . By $b = [a_1^2, a_2^3]$ we denote

that elements $a_1, a_2 \in A$ appear in b two and three times respectively.

The sum of two multisets b and b' over set A is defined as: $(b \uplus b')(a) = b(a) + b'(a)$ for all a from A . We say that $b \supseteq b'$ iff $\forall a \in A : b(a) \geq b'(a)$. For two multisets b and b' over set A , such that $b \supseteq b'$, the difference function is defined as: $(b \setminus b')(a) = b(a) - b'(a)$. The size of a multiset b over set A is denoted by $|b|$ and defined as $|b| = \sum_{a \in A} b(a)$.

Sets will be considered as a special case of multisets, where each element can appear 0 or 1 times. Thus, operations applicable to multisets can be applied to sets.

Function $f : X \dashrightarrow Y$ is a partial function with domain $dom(f) \subseteq X$ and range defined as $rng(f) = \{f(x) | x \in dom(f)\} \subseteq Y$. $f : X \rightarrow Y$ is a total function, i.e., $dom(f) = X$. Let $f : X \dashrightarrow Y$ be a partial function, f can be applied to sequences of X using the recursive definition $f(\langle \rangle) = \langle \rangle$ and for some $\sigma \in X^*$ and $x \in X$ $f(\langle x \cdot \sigma \rangle) = \langle f(x) \rangle \cdot f(\sigma)$, if $x \in dom(f)$ and $f(\langle x \cdot \sigma \rangle) = f(\sigma)$ otherwise.

2.1 Event logs and Petri nets

Definition 1 (Petri Net) A Petri net is a tuple $PN = (P, T, F)$ with P the set of places, T the set of transitions, $P \cap T = \emptyset$, and $F \subseteq (P \times T) \cup (T \times P)$ the flow relation.

Definition 2 (Marking) Let $PN = (P, T, F)$ be a Petri net. A marking M is a multiset of places, i.e., $M \in \mathcal{B}(P)$.

Definition 3 (Safe Marking) A marking M of a Petri net $PN = (P, T, F)$ is safe iff $\forall p \in P : M(p) \leq 1$, i.e., each place contains not more than 1 token.

Pictorially, places are represented by circles, transitions by boxes, and the flow relation F by directed arcs. Places may carry tokens represented by filled circles. A current marking M is designated by putting $M(p)$ tokens into each place $p \in P$.

For a node $n \in P \cup T$ the set of input nodes and the set of output nodes are defined as $\bullet n = \{x | (x, n) \in F\}$ and $n \bullet = \{x | (n, x) \in F\}$ respectively.

A transition $t \in T$ is enabled in a marking M of net PN , denoted as $(PN, M) [t]$, iff $\forall p \in \bullet t : M(p) \geq 1$, i.e., each of its input places contains at least one token.

An enabled transition t may fire, i.e., one token is removed from each of the input places $\bullet t$ and one token produced for each of the output places $t \bullet$. Formally: $M' = (M \setminus \bullet t) \uplus t \bullet$ is the marking resulting from firing enabled transition t in marking M of Petri net PN . $(PN, M) [t] (PN, M')$ denotes that t is enabled in M and firing results in marking M' .

Let $\sigma = \langle t_1, \dots, t_n \rangle \in T^*$ be a sequence of transitions. $(PN, M) [\sigma] (PN, M')$ denotes that there is a set of

markings M_0, M_1, \dots, M_n , such that $M_0 = M$, $M_n = M'$, and $(PN, M_i) [t_{i+1}] (PN, M_{i+1})$ for $0 \leq i < n$. We say that M' is reachable from M if there exists σ , such that $(PN, M) [\sigma] (PN, M')$.

$\mathcal{R}(PN, M)$ denotes the set of all markings reachable in PN from the marking M .

Definition 4 (Labeled Petri Net) A labeled Petri net $PN = (P, T, F, l)$ is a Petri net (P, T, F) with labeling function $l \in T \dashrightarrow \mathcal{U}_A$ where \mathcal{U}_A is some universe of activity labels. Let $\sigma_v = \langle a_1, \dots, a_n \rangle \in \mathcal{U}_A^*$ be a sequence of activity labels. $(PN, M) [\sigma_v \triangleright] (PN, M')$ iff there is a sequence $\sigma \in T^*$ such that $(PN, M) [\sigma] (PN, M')$ and $l(\sigma) = \sigma_v$.

If $t \notin dom(l)$, transition t is called invisible. An occurrence of visible transition $t \in dom(l)$ corresponds to observable activity label $l(t)$.

In the context of process mining we normally consider so-called complete firing sequences, thus we deal with processes, which have well-defined initial and end states. Therefore, let us give a notion of a system net.

Definition 5 (System Net) A system net is a triplet $SN = (PN, M_{init}, M_{final})$ where $PN = (P, T, F, l)$ is a labeled Petri net, $M_{init} \in \mathcal{B}(p)$ is the initial marking and $M_{final} \in \mathcal{B}(p)$ is the final marking.

Definition 6 (Language of a System Net) Suppose that $SN = (PN, M_{init}, M_{final})$ is a system net. Language L_{SN} of SN will be defined as a set of all visible execution sequences starting in M_{init} and ending in M_{final} , i.e., $L_{SN} = \{\sigma_v \mid (PN, M_{init}) [\sigma_v \triangleright] (PN, M_{final})\}$.

Event logs are considered as a starting point in the context of process mining, so let us give their formal definition.

Definition 7 (Trace, Event log) Let $A \subseteq \mathcal{U}_A$ be a set of activity labels. A trace $\sigma \in A^*$ is a sequence of activity labels. $L \in \mathcal{B}(A^*)$ is an event log, i.e., a multiset of traces.

Note that a trace can appear multiple times in an event log.

Some conversion techniques presented in this paper deal with free-choice nets. Let us define them.

Definition 8 (Free-choice Nets) A system net $SN = (PN, M_{init}, M_{final})$ and a corresponding labeled Petri net $PN = (P, T, F, l)$ are called free-choice iff for any two transitions $t_1, t_2 \in T$ with $\bullet t_1 \cap \bullet t_2 \neq \emptyset$ holds $\bullet t_1 = \bullet t_2$.

2.2 BPMN semantics

In this subsection we will present an approach for the formalization of BPMN control flow semantics based on a concept of token. This formalization will give an ability to justify the conversion algorithms presented later in this paper.

We restrict ourselves to the core set of BPMN elements, which includes activities, start and end events, exclusive and parallel gateways. We hope that these initial results will give a basis for formal description of more advanced BPMN modeling constructs.

Let us give a formal definition of a BPMN model.

Definition 9 (BPMN Model)

A BPMN model is a tuple $BPMN_{model} = (N, A, G_{XOR}, G_{AND}, e_{start}, E_{end}, SF, \lambda)$, where

- N is a set of flow nodes,
- $A \subseteq N$ is a set of activities,
- $G_{XOR} \subseteq N$, $G_{AND} \subseteq N$ are sets of exclusive and parallel gateways,
- $e_{start} \in N$ is a start event,
- $E_{end} \subseteq N$ is a set of end events,
- sets $A, G_{XOR}, G_{AND}, \{e_{start}\}, E_{end}$ form a partition of N ,
- $SF \subseteq N \times N$ is a set of sequence flows,
- $\lambda : N \rightarrow \mathcal{U}_A$ is a labeling function, where \mathcal{U}_A is some universe of activity labels,
- start event e_{start} doesn't have incoming sequence flows, and has not more than one outgoing sequence flow,
- end events from E_{end} don't have outgoing sequence flows.

Figure 4 shows the core BPMN constructs used to model processes.

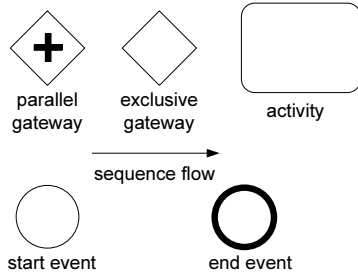

Fig. 4: Core BPMN modeling constructs

Let $n \in N$ be an arbitrary BPMN model node, the *preset* $\bullet n$ and the *postset* $n \bullet$ are defined as sets of incoming and outgoing sequence flows for the node n respectively.

To restrict the set of all possible BPMN models we will consider and discover *well-formed* BPMN models, which are revealed as weakly connected graphs with a source and sink nodes.

Definition 10 (Well-formed BPMN Model)

A BPMN model is called *well-formed* iff every node of this model is on a path from the start event to some end event.

Definition 11 (BPMN Model Marking)

Let $BPMN_{model}$ be a BPMN model with a set of sequence flows SF . A *marking* M is a multiset over the set sequence flows, i.e., $M \in \mathcal{B}(SF)$. An *initial marking* M_{init} is a marking, such that for all sf from SF $M_{init}(sf) = 1$, if $sf \in e_{start} \bullet$, and $M_{init}(sf) = 0$, otherwise.

An illustration for the initial marking is presented in Fig. 5.

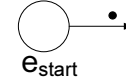

Fig. 5: Initial marking

Each node independently of its type may be *enabled*, an enabled node may *fire*. Let us consider an arbitrary BPMN model $BPMN_{model} = (N, A, G_{XOR}, G_{AND}, e_{start}, E_{end}, SF, \lambda)$ and define its firing rules:

1. An activity $a \in A$ is *enabled* in a marking M iff $\exists sf \in SF : (\bullet a(sf) = 1) \wedge (M \supseteq [sf^1])$. Suppose activity a is enabled, this activity may fire, producing a new marking M' , such that $M' = M \setminus [sf^1] \uplus a \bullet$. In other words activity a is enabled in marking M iff it has an incoming sequence flow, which contains at least one token. When activity fires it consumes one token from an incoming sequence flow and produces a token for each outgoing sequence flow (Fig. 6).

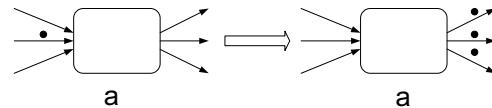

Fig. 6: Firing activity

2. Exclusive gateways merge alternative paths: the incoming sequence flow token is routed to one of the outgoing sequence flows (Fig. 7). Similar to activities exclusive gateway $g_{XOR} \in G_{XOR}$ is enabled in marking M iff there is an incoming sequence flow, which contains at least one token in marking M , i.e., $\exists sf \in SF : (\bullet g_{XOR}(sf) = 1) \wedge (M \supseteq [sf^1])$. In contrast to activities it produces a token to one of the outgoing sequence flows. Suppose an exclusive gateway g_{XOR} consumes a token from an incoming sequence flow sf and produces a token to an outgoing sequence flow sf' , then a new model marking M' will be defined as follows: $M' = M \setminus [sf^1] \uplus [sf'^1]$.

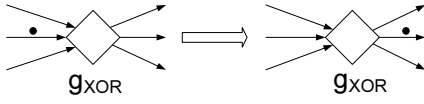

Fig. 7: Firing exclusive gateway

3. A parallel gateway $g_{AND} \in G_{AND}$ is enabled in marking M iff $\forall sf \in \bullet g_{AND} : M(sf) \geq 1$, i.e., each incoming sequence flow contains at least one token. An enabled parallel gateway g_{AND} may fire and produce a new marking: M' , such that $M' = M \setminus \bullet g_{AND} \uplus g_{AND}^\bullet$, i.e., a parallel gateway consumes a token from each incoming sequence flow and produces a token to each outgoing sequence flow (Fig. 8).

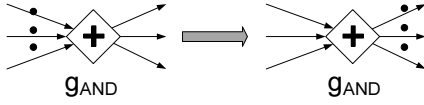

Fig. 8: Firing parallel gateway

4. The unique start event is never enabled, since it doesn't have any incoming sequence flow.
5. An end event $e_{end} \in E_{end}$ is enabled in marking M iff $\exists sf \in SF : (sf \in \bullet e_{end}) \wedge (M(sf) \geq 1)$. When end event fires, it consumes a token from an incoming sequence flow, and yields in a new marking $M' = M \setminus [sf^1]$ (Fig. 9).

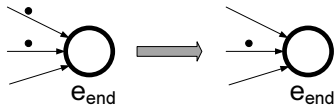

Fig. 9: Firing end event

When node $n \in N$ fires we denote this firing as $(BPMN_{model}, M) [n] (BPMN_{model}, M')$.

We write $(BPMN_{model}, M) [\sigma] (BPMN_{model}, M')$ for some sequence of nodes $\sigma = \langle n_1, \dots, n_k \rangle \in N^*$ iff there are markings M_0, \dots, M_k , such that $M_0 = M$, $M_k = M'$, and for $0 \leq i < k$ the following statement holds $(BPMN_{model}, M_i) [n_{i+1}] (BPMN_{model}, M_{i+1})$.

Likewise in Petri nets marking M' is *reachable* from marking M iff there is a sequence $\sigma \in N^*$, such that $(BPMN_{model}, M) [\sigma] (BPMN_{model}, M')$.

For some sequence of activity labels $\sigma_v \in \mathcal{U}_A^*$ we write $(BPMN_{model}, M) [\sigma_v \triangleright (BPMN_{model}, M')$, if there is σ , such that $(BPMN_{model}, M) [\sigma] (BPMN_{model}, M')$ and $\lambda(\sigma) = \sigma_v$.

By $\mathcal{R}(BPMN_{model}, M)$ we will denote the set of all markings reachable in $BPMN_{model}$ from the marking M .

To define the notion of language generated by a BPMN model let us first give a definition of a final marking.

Definition 12 (Final BPMN Model Marking) Let $BPMN_{model}$ be a BPMN model with an initial marking M_{init} and a set of nodes N . M_{final} is a *final marking* iff $M_{final} \in \mathcal{R}(BPMN_{model}, M_{init})$ and $\forall n \in N \nexists M' : (BPMN_{model}, M) [n] (BPMN_{model}, M')$.

As it follows from this definition, the final marking of a BPMN model is the marking, in which no node can fire.

Definition 13 (Language of a BPMN Model) Let $BPMN_{model}$ be a BPMN model with an initial marking M_{init} and a set of final markings \mathcal{M}_{final} . The *language* of $BPMN_{model}$ is a set $L_{BPMN_{model}} = \{\sigma_v \mid (BPMN_{model}, M_{init}) [\sigma_v \triangleright (BPMN_{model}, M) \wedge M \in \mathcal{M}_{final}]\}$.

Thus, we define the language of a BPMN model as a set of all visible sequences starting in an initial marking and ending in some final marking.

According to the BPMN 2.0 specification [30] BPMN model gets the status *completed* iff there is no token remaining. Following the specification, a language of a BPMN model can be considered as a union of two disjoint sets:

$$L_{BPMN_{model}} = V_{BPMN_{model}} \cup I_{BPMN_{model}}$$

$V_{BPMN_{model}} = \{\sigma_v \mid ((BPMN_{model}, M_{init}) [\sigma_v \triangleright (BPMN_{model}, M)) \wedge (\forall sf \in SF : M(sf) = 0)]\}$ is a set of *valid sequences*, corresponding to the model executions, which lead to markings with no tokens remaining. Note that according to BPMN semantics if no tokens remaining, no node is enabled.

$I_{BPMN_{model}} = L_{BPMN_{model}} \setminus V_{BPMN_{model}}$ stands for a set of *invalid sequences*, which are the traces of the BPMN model executions, stopped in markings with tokens on sequence flows. These sequences of activity labels correspond to the BPMN model deadlocks.

2.3 Transition systems, reachability graphs and simulation relations

In this subsection some basic definitions, which are used for the justification of the conversion algorithms, will be given.

Definition 14 (Transition system) Let S and E be two disjoint non-empty sets of *states* and *events*, let $\tau \in E$ be a special *silent event*, and let $B \subseteq S \times E \times S$ be a *transition relation*. A *transition system* is a tuple $TS = (S, E, B, s_{in})$, where $s_{in} \in S$ is an initial state. Elements of B are called *transitions*.

We write $s \xrightarrow{e} s'$, when $(s, e, s') \in B$. Assume that $\forall s \in S : s \xrightarrow{\tau} s$, i.e., there is a transition from every state to itself, labeled by τ .

A state s is *reachable* from a state s' iff there is a (possibly empty) sequence of transitions leading from s to s' (denoted by $s \xrightarrow{*} s'$). The reflexive transitive closure of $\xrightarrow{\tau}$ will be denoted as \Rightarrow . By $s \xRightarrow{e} s'$ we denote $s \Rightarrow s'' \xrightarrow{e} s''' \Rightarrow s'$, i.e., s' can be reached from s via e preceded and followed by zero or more τ transitions.

A transition system must satisfy the following basic axiom: every state is reachable from the initial state: $\forall s \in S : s_{in} \xrightarrow{*} s$.

Definition 15 (Simulation) For transition systems: $TS = (S, E, B, s_{in})$ and $TS' = (S', E, B', s'_{in})$ relation $R \subseteq S \times S'$ is called a *simulation* iff:

- $(s_{in}, s'_{in}) \in R$,
- $\forall (u, v) \in R \forall e \in E$: if $\exists u' : u \xrightarrow{e} u'$ then $\exists v' : v \xrightarrow{e} v'$ and $(u', v') \in R$.

Definition 16 (Weak simulation) Let us consider two transition systems: $TS = (S, E, B, s_{in})$ and $TS' = (S', E, B', s'_{in})$. Relation $R \subseteq S \times S'$ is called a *weak simulation* iff:

- $(s_{in}, s'_{in}) \in R$,
- $\forall (u, v) \in R \forall e \in E$: if $\exists u' : u \xrightarrow{e} u'$ then $\exists v' : v \xrightarrow{e} v'$ and $(u', v') \in R$.

Definition 17 (Bisimulation) If R is a (*weak*) *simulation* relation and R^{-1} is a (*weak*) *simulation* relation as well, then relation R is called a (*weak*) *bisimulation*.

Definition 18 (Reachability Graph for a System Net) A *reachability graph* for a system net $SN = (PN, M_{init}, M_{final})$, where $PN = (P, T, F, l)$, and $l \in T \rightarrow \mathcal{U}_A$, is a transition system $TS = (S, E, B, s_{in})$, such that:

- $S = \mathcal{R}(SN, M_{init})$, i.e., the set of states is defined as a set of markings reachable from M_{init} ,
- $E = rng(l) \cup \{\tau\}$, i.e., the set of events is defined as a union of the range of l and a silent event τ ,
- B contains a transition (M, e, M') iff at least one the following conditions holds:
 - $\exists t \in T : (SN, M) [t] (SN, M')$, such that $l(t) = e$, if $t \in dom(l)$, or $e = \tau$, otherwise,
 - $M = M'$ and $e = \tau$, this holds for silent transitions from states to itself.
- $s_{in} = M_{init}$, i.e., the initial state in TS is the initial marking of SN .

Definition 19 (Reachability graph for a BPMN model) A *reachability graph* for a BPMN model $BPMN_{model} = (N, SF, A, G_{XOR}, G_{AND}, e_{start}, E_{end}, \lambda)$ with an initial marking M_{init} is defined as a transition system $TS = (S, E, B, s_{in})$, such that:

- $S = \mathcal{R}(BPMN_{model}, M_{init})$,
- $E = rng(\lambda) \cup \{\tau\}$, where τ is a special silent event,
- $(M, e, M') \in B$ iff at least one of the following conditions holds:
 - there exists $n \in N$, such that $(BPMN_{model}, M) [n] (BPMN_{model}, M')$, where $\lambda(n) = e$, if $n \in dom(\lambda)$, or $e = \tau$, otherwise,
 - $M = M'$ and $e = \tau$.
- $s_{in} = M_{init}$.

3 Converting process models into BPMN

In this section we will propose algorithms for the conversion from well-known formalisms such as Petri nets, causal nets and process trees to BPMN. These formalisms are widely used within process mining as results of application of process discovery algorithms [9, 10, 12, 16, 20, 26, 36]. Having conversion algorithms to BPMN format will give an opportunity to discover control flow models, which could be integrated with other process perspectives. The correctness of the proposed system nets conversion algorithm will be proven.

Algorithms for conversion of free-choice workflow nets [3] (a special subset of Petri nets) to *workflow graphs* (generalization concept for process modeling notations such as BPMN, UML Activity [31], EPC [25, 28], etc) were proposed earlier in [2] and [19]. In our paper we will deal with arbitrary system nets, which have arbitrary Petri nets structures and arbitrary safe initial markings. Also we prove that the target model will simulate the behavior of the initial net and vice versa, thus important (in the context of process mining) propositions on the language preservation will be proven.

First, let us show that every system net with a safe initial marking can be transformed to an equivalent system net, which contains a unique source place.

3.1 Adding a source place to an arbitrary system net with a safe initial marking

In most cases models discovered from event logs are arbitrary system nets with safe initial markings. We start with transforming of a system net with a safe initial marking into a system net, which contains a unique source place and doesn't contain hanging places (places without outgoing arcs). In the next subsections we will show algorithms for conversion of such nets to BPMN.

Algorithm 1 [Adding a source place to a system net].

Input: A system net $SN = (PN, M_{init}, M_{final})$, where $PN = (P, T, F, l)$, such that $\forall p \in P : M_{init}(p) \leq 1$.

Step 0: Adding a source place. Add a novel place $i \in P$, a novel initial transition t^* (note that t^* doesn't have a

label, since $t^* \notin \text{dom}(l)$, and connect them with an arc (i, t^*) . For each place $p \in P$, such that $M_{\text{init}}(p) = 1$, add an arc (t^*, p) . This step is presented in Fig. 10.

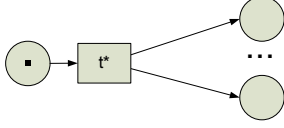

Fig. 10: Creating a source place

Step 1: Handling unconnected transitions. For each transition $t \in T$, such that $\bullet t = \emptyset$, add a place p , connected with t by an incoming and outgoing arc. Add an arc from the initial transition t^* to the place p (Fig. 11).

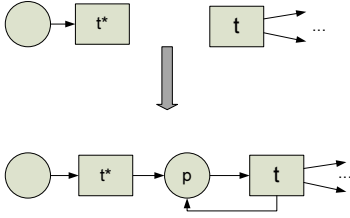

Fig. 11: Handling unconnected transitions

Step 2: Removing dead places. Remove each place $p \in P$ and transitions from p^\bullet along with incident arcs, if there is no path from i to p . Repeat Step 2 until there are dead places.

Step 3: Removing hanging places. Remove all places $p \in P$, such that $|p^\bullet| = 0$, along with incident arcs.

Step 4: Constructing novel markings. Suppose that P' is the resulting set of places, and $P^* \subseteq P'$ is the set of places added at Step 1. Then the initial and final markings M'_{init} and M'_{final} are defined as follows: for all $p \in P'$, such that $p \neq i$, $M'_{\text{init}}(p) = 0$, $M'_{\text{init}}(i) = 1$, for all $p \in P^*$ holds that $M'_{\text{final}}(p) = 1$, and for all $p \in (P \cap P')$ the number of tokens is preserved, i.e., $M'_{\text{final}}(p) = M_{\text{final}}(p)$. The source place doesn't contain any tokens in the final marking, i.e., $M'_{\text{final}}(i) = 0$.

Output: A system net $SN' = (PN', M'_{\text{init}}, M'_{\text{final}})$, where $PN' = (P', T', F', l)$ is defined on the basis of $PN = (P, T, F, l)$ at Steps 0-3. Markings M'_{init} and M'_{final} are defined at Step 4.

Proposition 1 Let $SN = (PN, M_{\text{init}}, M_{\text{final}})$ be a system net and $SN' = (PN', M'_{\text{init}}, M'_{\text{final}})$, where $PN' = (P', T', F', l)$,

be a result of applying Algorithm 1 to SN . Let $i \in P'$ be a source place constructed by Algorithm 1. Then for each node $n \in (P' \cup T')$ exists a path from i to n .

Proof. Suppose that $n \in P'$. Since all the places, to which there were no paths from i , were deleted at the Step 2, there exists a path from i to n . If $n \in T'$, then either n didn't have incoming arcs and was connected with i at the Step 1, or either it is connected by an incoming arc with a place, and for this place there is a path from i , hence there is a path from i to n . \square

Note that places, which were added at Step 1, contain tokens in any reachable marking.

Algorithm 1 transforms a system net with a safe initial marking to an *equivalent* system net with a source place and no hanging places. More formally, there is a *weak bisimulation* relation between reachability graphs of the initial and the target system nets. The proof is straightforward according to Definition 17. Further we will consider only system nets with unique source places and without hanging places and call them just system nets.

3.2 Free-choice system nets to BPMN conversion

In this subsection an algorithm for conversion from a free-choice system net to a BPMN model will be presented.

The conversion algorithm will be illustrated by a running example: a system net, which defines a booking process (Fig. 12), will be converted to an equivalent BPMN model. The source place is $p1$, the final marking M'_{final} is the marking, such that $M'_{\text{final}}(p) = 0$ for all p .

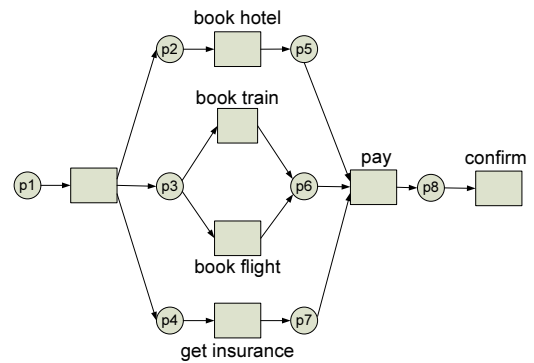

Fig. 12: A system net of a booking process

Note that in contrast to the booking model presented earlier (Fig. 1), this model contains a choice construction (the user books a flight or a train ticket), also note that there is a transition used as a splitting node, this transition doesn't

have a label.

Algorithm 2 [Constructing a BPMN model for a system net].

Input: A free-choice system net SN , where $SN = (PN, M_{init}, M_{final})$, $PN = (P, T, F, l)$, and i is a source place.

Step 0: Initializing BPMN model.

Determine a BPMN model $BPMN_{model} = (N, A, G_{XOR}, G_{AND}, e_{start}, E_{end}, SF, \lambda)$, which contains a start event only, i.e., $N = \{e_{start}\}$, $SF = \emptyset$, $A = \emptyset$, $G_{XOR} = \emptyset$, $G_{AND} = \emptyset$, and $E_{end} = \emptyset$ (Fig. 13).



Fig. 13: An initial BPMN model

Step 1: Converting transitions.

Create a BPMN model activity $a \in A$ for each transition $t \in T$, determine the corresponding bijective mapping function $M : T \rightarrow A$. The labeling function λ is defined as follows $\lambda(M(t)) = l(t)$, for all t from $dom(l)$. If there exists a transition $t \in T$, such that $|t^\bullet| > 1$, i.e., t has more than one outgoing arc, add a parallel gateway g_{AND} and a sequence flow $(M(t), g_{AND})$. $BPMN_{model}$ with activities and a parallel gateway added is shown in Fig. 14.

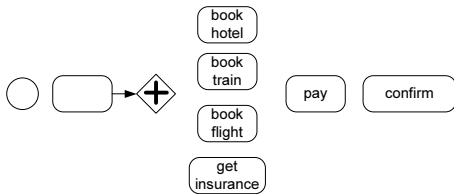

Fig. 14: Adding activities and parallel gateways to the BPMN model of a booking process

Step 2: Converting places.

In this step each place $p \in P$ is converted to BPMN routing constructs, identifying a corresponding *place node* and a corresponding *place flow* within $BPMN_{model}$. During the BPMN model construction we will define functions, which map places from P to corresponding *place nodes* and *place flows* for $BPMN_{model}$, and denote them as $\mathcal{N} : P \rightarrow N$ and $\mathcal{F} : P \rightarrow SF$, where N and SF - are the sets of $BPMN_{model}$ nodes and sequence flows respectively. The function \mathcal{N} will be used to define nodes, which correspond to places, and used for establishing connections within the target model. The function \mathcal{F} will be used to show the relations between places and sequence flows, and will

help to relate a system net and a BPMN model markings.

Step 2.1: Connecting to inputs. Let us transform places and identify *place nodes*, taking into account presets:

- If $|\bullet p| = 0$ (p doesn't have incoming arcs), then place p is a source place of SN , and the *place node* will be defined as e_{start} , i.e., $\mathcal{N}(p) = e_{start}$.
- If $|\bullet p| = 1$, i.e., there exists one and only one transition $t \in T$ connected with p by an outgoing arc. If there exists $g_{AND} \in G_{AND}$, such that $(M(t), g_{AND}) \in SF$, then the *place node* is set to g_{AND} : $\mathcal{N}(p) = g_{AND}$, otherwise $\mathcal{N}(p) = M(t)$.
- If $|\bullet p| > 1$ (there is more than one transition connected with p by outgoing arc), then an exclusive gateway g_{XOR} is added to G_{XOR} and for each transition t from $\bullet p$ a sequence flow is added to SF . If there exists $g_{AND} \in G_{AND}$, such that $(M(t), g_{AND}) \in SF$, this sequence flow is defined as (g_{AND}, g_{XOR}) , otherwise the sequence flow is $(M(t), g_{XOR})$. The exclusive gateway g_{XOR} is set as the *place node* for p , i.e., $\mathcal{N}(p) = g_{XOR}$.

The result of applying Step 2.1 to the booking process is shown in Fig. 15. For each place of the initial system net a corresponding *place node* is specified.

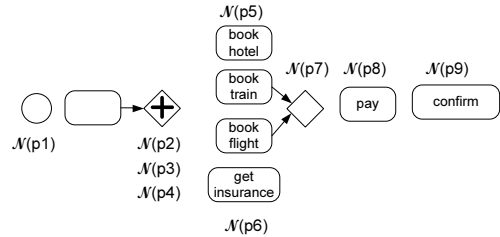

Fig. 15: Identifying place nodes

Step 2.2: Merging places with coinciding postsets:

For all maximum sets of places $\{p_1, \dots, p_n\} \subseteq P$ with coinciding non-empty postsets ($p_1^\bullet = \dots = p_n^\bullet$)¹, such that $n \geq 2$, an additional parallel gateway g_{AND} is added to G_{AND} . This gateway is connected by incoming sequence flows with all the corresponding *place nodes*, i.e., sequence flows $(\mathcal{N}(p_1), g_{AND})$, \dots , $(\mathcal{N}(p_n), g_{AND})$ are added to SF and are defined as place flows: for all s_i from $\{s_1, \dots, s_n\}$, $\mathcal{F}(s_i) = (\mathcal{N}(p_i), g_{AND})$. After that the parallel gateway g_{AND} is considered to be a novel *place node* for places p_1, \dots, p_n , i.e., $\mathcal{N}(p_1) = g_{AND}$, \dots , $\mathcal{N}(p_n) = g_{AND}$.

¹Note that due to the free-choice structure of PN , postsets either coincide or do not intersect.

Fig. 16 shows the result of applying the places merge procedure to the booking process presented in Fig. 15.

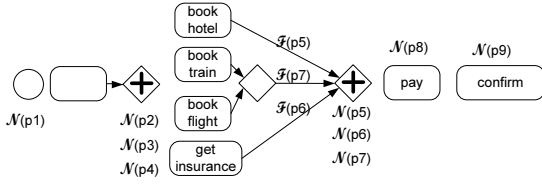

Fig. 16: Merging places with coinciding postsets

Step 2.3: Connecting to outputs. In this step for each group of places p_1, \dots, p_n with coinciding postsets: $post = p_1^\bullet = \dots = p_n^\bullet$ ² corresponding place nodes: $\mathcal{N}(p_1), \dots, \mathcal{N}(p_n)$ are connected by outgoing sequence flows with other BPMN model elements.

- If $|post| = 1$, i.e., there is only one transition $t \in T$ connected with p_1, \dots, p_n by incoming arcs, then sequence flow $(\mathcal{N}, M(t))$, where $\mathcal{N} = \mathcal{N}(p_1) = \dots = \mathcal{N}(p_n)$ ³, is added to SF . If the group of places with coinciding postsets contains only one node (let this node be p_1), then $\mathcal{F}(p_1) = (\mathcal{N}, M(t))$.
- If $|post| > 1$, an exclusive gateway g_{XOR} and a sequence flow (\mathcal{N}, g_{XOR}) are added to G_{XOR} and SF respectively³. Then for each t from $post$ a sequence flow $(g_{XOR}, M(t))$ is added to SF . If $n = 1$, $\mathcal{F}(p_1) = (\mathcal{N}, g_{XOR})$.

The resulting BPMN model is shown in Fig. 17.

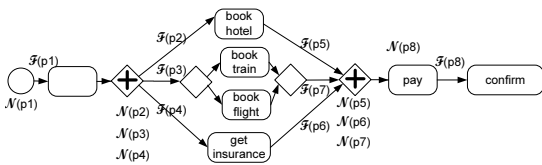

Fig. 17: The resulting BPMN model

Output: $BPMN_{model}$ and mappings: $M, \mathcal{N}, \mathcal{F}$.

3.3 Non-free-choice system nets to BPMN

Often non-free-choice Petri nets, which allow more behavior than free-choice Petri nets, are obtained as a result of applying process discovery algorithms. In this subsection

²Note that we consider system nets without hanging places.

³All the places have the same place node \mathcal{N} , obtained on the previous step of the algorithm.

we will introduce an algorithm for constructing free-choice Petri nets from Petri nets with non-free-choice constructions. This algorithm works as follows: for each arc, which produces a non-free-choice construction, do the transformation presented in Fig. 18. A more formal description of the algorithm is presented below.

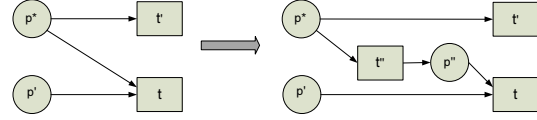

Fig. 18: Converting non-free-choice Petri nets into free-choice Petri nets

Algorithm 3 [Constructing a free-choice Petri net from an arbitrary Petri net].

Input: A labeled Petri net $PN = (P, T, F, l)$.

For each arc (p^*, t) , $p^* \in P$, $t \in T$, such that $\exists t' \in T : p^* \in (\bullet t \cap \bullet t')$ and $\exists p' \in P : p' \in \bullet t, p' \notin \bullet t'$ do the following transformation: remove flow (p^*, t) , add transition t'' , place p'' , and connecting sequence flows: (p^*, t'') , (t'', p'') , (p'', t) (see Fig. 18). The labeling function l is not defined for t'' , i.e., $t'' \notin \text{dom}(l)$.

Output: Labeled Petri net $PN' = (P \cup \{p''\}, T \cup \{t''\}, F \cup \{(p^*, t''), (t'', p''), (p'', t)\}, l)$.

The algorithm can be applied iteratively, arcs can be considered in any order, since each transformation doesn't change the set of arcs, which have to be replaced.

3.4 System nets conversions justification

This subsection presents justifications of the system nets conversion algorithms.

Let us prove that Algorithm 2 preserve structural and some behavioral properties of a process model.

Lemma 1 Let SN , where $SN = (PN, M_{init}, M_{final})$, and $PN = (P, T, F, l)$, be a free-choice system net with a source place i . Let $BPMN_{model}$ be a result of applying Algorithm 2 to SN . Suppose that $M : T \rightarrow A$ is a mapping function obtained during an execution of Algorithm 2. Suppose also that $\mathcal{N} : P \rightarrow N$ is a function, which defines place nodes in $BPMN_{model}$. Then for any two places $p_1, p_2 \in P$, such that $\exists t \in T : (t \in p_1^\bullet) \wedge (t \in \bullet p_2)$ (Fig. 19), there are paths from $\mathcal{N}(p_1)$ to $M(t)$ and from $M(t)$ to $\mathcal{N}(p_2)$ within $BPMN_{model}$.

Proof. According to the Algorithm 2 node $\mathcal{N}(p_1)$ is either directly connected with $M(t)$ or directly connected with

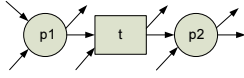

Fig. 19: Connected places

its immediate predecessor - an exclusive gateway (see Step 2.3). Hence there is a path from $\mathcal{N}(p_1)$ to $M(t)$. Now let us consider $\mathcal{N}(p_2)$. This node is either $M(t)$ activity or a gateway, such that there is a path from $M(t)$ to this gateway (see Steps 2.1, 2.2). This implies that there is a path from $M(t)$ to $\mathcal{N}(p_2)$ within $BPMN_{model}$. \square

Lemma 2 *Suppose that SN , is a system net with a source place i . Then the result of applying Algorithm 2 is $BPMN_{model} = (N, SF, A, G_{XOR}, G_{AND}, e_{start}, E_{end}, \lambda)$, such that for each node there is a path from e_{start} to this node.*

Proof. Source place i is converted to the start event e_{start} . It inductively follows from Lemma 1 that all the *place nodes* and all the activities A are located on paths from e_{start} . All other BPMN model nodes are gateways G_{XOR} , G_{AND} and end events E_{end} , which lie on paths from *place nodes* to activities or from activities to the *place nodes* by the construction, consequently they are also located on paths from e_{start} . \square

Theorem 1 (Well-formedness) *Every system net with a safe initial marking can be converted to a well-formed BPMN model.*

Proof. Algorithm 3 allows to construct free-choice system nets from non-free choice system nets, preserving nodes connectivity. Proposition 1 shows that an arbitrary system net with a safe initial marking can be converted to an equivalent system net, which has a unique source place, such that for every node of this net there is a path from the source place to this node. Lemma 2 allows us to construct a BPMN model, where for each node there is a path from the start event to this node. According to Algorithm 2 the only possible hanging nodes in the target BPMN model are activities. Thus, additional end events can be added to the BPMN model and connected by incoming sequence flows with activities, making all the nodes be on paths from a start event to end events. \square

Note that end events consume tokens from incoming sequence flows, thus the global execution order of BPMN model will not be changed. Since end events don't change the global execution order, further we will prove some propositions for model conversions, which don't involve addition of end events.

Now let us discuss the behavioral relation between initial system net and the BPMN model generated by Algorithm 2.

We will show that each firing of a Petri net corresponds to a sequence of the BPMN model firings.

Theorem 2 (Weak similarity)

Let SN be a free-choice system net with a source place i , where $SN = (PN, M_{init}, M_{final})$, $PN = (P, T, F, l)$. Let $BPMN_{model}$ be a result of applying Algorithm 2 to SN , $M : T \rightarrow A$ is the mapping function. Let $TS = (S, E, B, s_{in})$, $TS' = (S', E', B', s'_{in})$ be reachability graphs of SN and $BPMN_{model}$ respectively. There exist weak simulation relations R and R' from TS to TS' and from TS' to TS respectively, such that:

1. $(u, v) \in R$ iff $\forall p \in P : u(p) = v(\mathcal{F}(p))$,
2. if $(u, v) \in R$ then $(v, u) \in R'$,
3. $\forall v \in S' \exists v' \in S' : (v \xrightarrow{*} v') \wedge (\exists u' \in S : (u', v') \in R)$. In other words, from each state $v \in S'$ it is always possible to reach some state $v' \in S'$, which is in the relation R with some state $u' \in S$.

But it is not guaranteed that a weak bisimulation relation exists.

Proof. Let us prove the existence of *weak simulation* relations R and R' between TS and TS' inductively on pairs of states $u \in S, v \in S'$ such that $\forall p \in P : u(p) = v(\mathcal{F}(p))$.

Induction basis.

1. Pairs (s_{in}, s'_{in}) and (s'_{in}, s_{in}) belong to R and R' respectively by the definition of a *weak simulation* relation. Both variants for initial markings of SN and $BPMN_{model}$ are presented in Fig. 20. Tokens in Fig. 20 are represented by black dots. As can be seen $\forall p \in P : s_{in}(p) = s'_{in}(\mathcal{F}(p))$. For the proof of condition 3. see the *Induction step*.

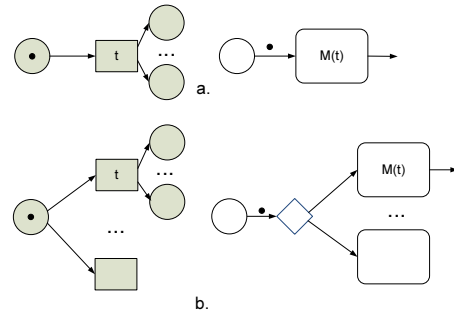
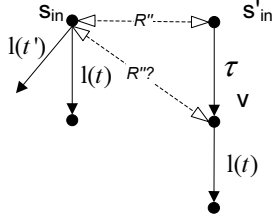

Fig. 20: Initial markings

2. Let us prove that there is no weak bisimulation relation between TS and TS' . Suppose there is such a relation R'' (Fig. 21), then by the definition $(s'_{in}, s_{in}) \in R''$.

Fig. 21: Construction of a *weak bisimulation* relation

For variant **b.** it holds that exists $v \in S'$, such that $s'_{in} \xrightarrow{\tau} v$, and $M(t)$ is enabled in v . The only state in TS , to which there is a transition from s_{in} labeled by τ , is s_{in} itself, thus $(s_{in}, v) \in R''$. State s_{in} has at least one outgoing transition labeled with $l(t')$, such that $t' \neq t$. Suppose that $l(t) \neq l(t')$, then we get a contradiction, since v doesn't have an outgoing transition labeled by $l(t')$.

Induction step.

1. Now let us consider state $u \in S$ (Fig. 22)

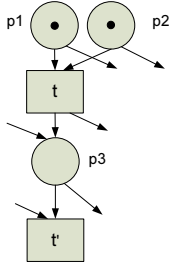
Fig. 22: Marking u of a system net

By the induction hypothesis there exists a state v in TS' (a marking of $BPMN_{model}$), such that $(u, v) \in R$ (Fig. 23).

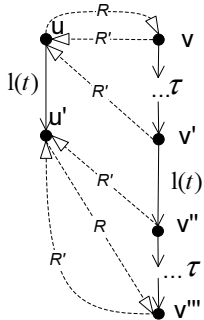
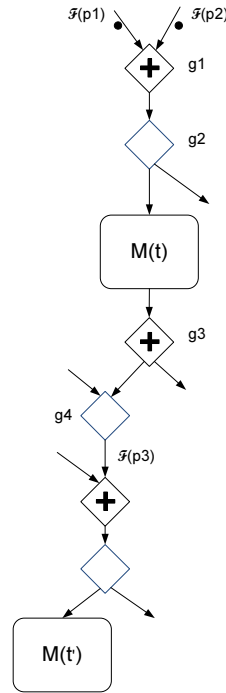

Fig. 23: Current states in transition systems

Furthermore, by the induction hypothesis the following condition holds: $\forall p \in P : u(p) = v(\mathcal{F}(p))$, i.e., each

place and its corresponding *place flow* contain the same number of tokens. Note that more than one token can appear in a place.

Now let us show that if TS has a transition from state u , TS' has a corresponding sequence of transitions from state v , i.e., $\exists v''' : v \xrightarrow{l(t)} v'''$ and $\forall p \in P : u'(p) = v'''(\mathcal{F}(p))$. Thus, (u', v''') will belong to R . State v of $BPMN_{model}$ is presented in Fig. 24. Note that we consider the most general case, which represents all the routing elements. The remaining cases can be treated similarly. The gateway g_1 is enabled in marking v (by the construction, since t is enabled in u) and can fire, producing a novel marking, in which firing g_2 yields $M(t)$ being enabled.

Fig. 24: Marking v of a BPMN model

Let us call the marking, in which $M(t)$ is enabled, u' , then $u \Rightarrow u'$. After $M(t)$ fires, some marking v'' is reached: $v' \xrightarrow{l(t)} v''$. Starting from marking v'' firings of gateways lead to adding a novel token to each *place flow*, which corresponds to some place from t^\bullet , and producing marking v''' : $v'' \Rightarrow v'''$, i.e., $v \xrightarrow{l(t)} v'''$. Note that $\forall p \in P$, holds that:

$$v'''(\mathcal{F}(p)) = \begin{cases} v(\mathcal{F}(p)) - 1, & \text{if } p \in \bullet t, p \notin t^\bullet, \\ v(\mathcal{F}(p)) + 1, & \text{if } p \in t^\bullet, p \notin \bullet t, \\ v(\mathcal{F}(p)), & \text{otherwise.} \end{cases}$$

Initial conditions $u' = u - \bullet t + t^\bullet$ and $\forall p \in P : v(\mathcal{F}(p)) = u(p)$, allow to conclude that $\forall p \in P : u'(p) = v'''(\mathcal{F}(p))$.

2. Let us consider state $v \in S'$. By the induction hypothesis if $\exists u \in S' : ((v, u) \in R') \wedge (\forall p \in P : v(\mathcal{F}(p)) = u(p))$. Two variants are possible either v doesn't have outgoing transitions and then $v \Rightarrow v$ and all the theorem conditions hold. Or there is a set of states V' , such that $\forall v' \in V' : v \Rightarrow v'$, i.e., all $v' \in V'$ are reachable from v by τ transitions. In this case there is a state v'_1 , such that $v \Rightarrow v'_1$ and $M(t)$ is enabled in v'_1 . Transition t is enabled in u by the induction hypothesis and by the construction. Pair (v'', u') belongs to R' , where $v'_1 \xrightarrow{l(t)} v''$ and $u \xrightarrow{l(t)} u'$. Let us denote the set of states v^* , such that $v'' \Rightarrow v^*$, as V^* , and (v^*, u') belongs to R' for $\forall v^* \in V^*$. The state $v''' \in TS'$, such that $\forall p \in P : v'''(\mathcal{F}(p)) = u'(p)$, is reachable from any state in V^* by the construction. Thus, the induction hypothesis and the condition 3. are proven.

Thus, it was shown that there are *weak simulation* relations between TS and TS' , and conditions 1.-3. are hold. In the *Induction basis* it was shown, that there is no *weak bisimulation* relation between TS and TS' . \square

This theorem has an important corollary within the process mining context : the conversion algorithm allows to preserve the language of a free-choice system net under some assumption.

Corollary 1 (Language equivalence for free-choice system net) *Suppose there is a free-choice system net SN , where $SN = (PN, M_{init}, M_{final})$, and i is a source place. Suppose also that M_{final} is the only reachable marking, in which no transition enabled, i.e., if $M \in \mathcal{R}(PN, M_{init})$ then $M \neq M_{final}$ iff $\exists t \exists M' : (PN, M) [t] (PN, M')$. Let $BPMN_{model}$ be a result of applying Algorithm 2 to SN , then $L_{SN} = L_{BPMN_{model}}$.*

Proof. 1. Let us consider a trace σ_v , such that $(PN, M_{init}) [\sigma_v \triangleright (PN, M_{final})$, i.e., $\sigma_v \in L_{SN}$. There is a weak simulation relation $R \subseteq (S \times S)$ from TS to TS' , where TS and TS' are reachability graphs for SN and $BPMN_{model}$ respectively. Thus, σ_v can be replayed in $BPMN_{model}$, and after the replay $BPMN_{model}$ will be in a marking M , such that $(M_{final}, M) \in R$. If $\exists n \exists M' (BPMN_{model}, M) [n] (BPMN_{model}, M')$, then since $\forall p \in P : M_{final}(p) = M(\mathcal{F}(p))$, $\exists M''(PN, M_{final}) [t] (PN, M'')$, we get a contradiction. Thus, $L_{SN} \subseteq L_{BPMN_{model}}$.

2. Now let us prove that $L_{BPMN_{model}}$ do not contain traces, which do not belong to L_{SN} . Suppose there is a trace $\sigma_v \in L_{BPMN_{model}}$, such that $(BPMN_{model}, M'_{init}) [\sigma_v \triangleright (BPMN_{model}, M)$, where M'_{init} is an initial marking of $BPMN_{model}$. Theorem 2 states that there exists $BPMN_{model}$ marking M' , such that $(M \Rightarrow M') \wedge (\exists M'' : (M'', M') \in R)$, where M'' is a marking of SN . By the definition of BPMN model language no node can fire at the marking

M , thus $M = M'$, and $(M'', M) \in R$. We get that M'' is also a state (SN marking) without outgoing transitions, otherwise M is not a final marking of a $BPMN_{model}$, since $(M'', M) \in R$. Thus, $\sigma_v : (SN, M_{init}) [\sigma_v \triangleright (SN, M'')$, and $\sigma_v \in L_{SN}$. \square

Now let us compare behavioral properties of non-free-choice Petri nets and corresponding free-choice Petri nets constructed by Algorithm 3.

Theorem 3 (Non-free-choice Petri nets conversion) *Let $PN = (P, T, F, l)$ be an arbitrary labeled Petri net, and $PN' = (P', T', F', l)$ be a result of applying Algorithm 3 to PN . Let $TS = (S, E, B, s_{in})$ and $TS' = (S', E, B', s'_{in})$ be reachability graphs of PN and PN' respectively. Then there are weak simulation relations from TS to TS' , and from TS' to TS . But it is not guaranteed that a weak bisimulation relation exists.*

Proof. Let us define *weak simulation* relations R and R' between TS and TS' in such a way that for every two states $s \in S$ and $s' \in S'$ if $\forall p \in P : s(p) = s'(p)$, then (s, s') belongs to R and (s', s) belongs to R' . Let us consider a place $p^* \in P$ (Fig. 25), such that $\exists t, t' \in T : p^* \in (\bullet t \cap \bullet t')$ and $\exists p' \in P : p' \in \bullet t', p' \notin \bullet t$. For this place the out-

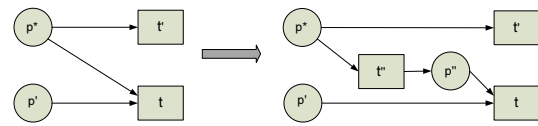

Fig. 25: Splitting non-free-choice construction

put flow will be modified according to Algorithm 3. Let us consider u - a marking of PN : $u(p^*) \geq 1$ and construct fragments of reachability graphs for PN and PN' , containing the marking u and a corresponding marking of PN' - $v : \forall p \in P : v(p) = u(p)$ (Fig. 26).

Suppose that t is enabled in u , and u' is a state (PN marking) obtained after firing of transition t : $u \xrightarrow{l(t)} u'$, then t is also enabled in v , and v' is a marking of PN' , such that $v \xrightarrow{l(t)} v'$, then $\forall p \in P : v'(p) = u'(p)$, and $(u', v') \in R$, $(v', u') \in R$. Now suppose that t' is enabled in u and can fire producing a novel marking u''' . For TS' there is a corresponding state v''' , such that $v \xrightarrow{\tau} v'' \xrightarrow{l(t')} v'''$, and $\forall p \in P : v'''(p) = u'''(p)$. Pair (u''', v''') will belong to R , pairs (v''', u''') , (v'', u) will belong to R' . Note that the state u can simulate v'' , since $\forall p \in P, p \neq p^* : u(p) = v''(p)$, thus, it includes behavior allowed in v'' . The procedure of defining R and R' can be considered for each transformation of PN , thus *weak simulation* relations between TS and TS' can be derived.

There is no bisimulation relation, since there is no state, which bisimulates v'' .

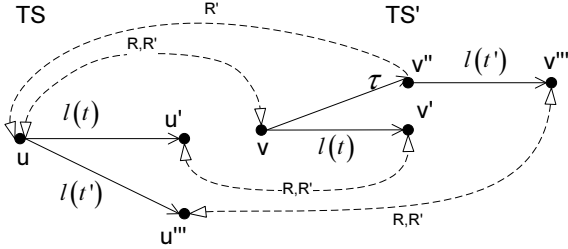

Fig. 26: Simulation of non-free-choice net by the corresponding free-choice net

□

Corollary 2 (Language of non-free choice system net)

Let $SN = (PN, M_{init}, M_{final})$ be an arbitrary system net, where $PN = (P, T, F, l)$. Let us apply Algorithm 3 to PN and obtain a free-choice Petri net $PN' = (P', T', F', l)$. Let us consider a system net $SN' = (PN', M_{init}, M_{final})$ with the same initial and final markings (we can construct such a system net since $P \subseteq P'$). Then $L_{SN} = L_{SN'}$.

Proof. Let TS and TS' be reachability graphs of SN and SN' respectively. As it follows from Theorem 3 TS' simulates TS and vice versa, also they have the same final marking M_{final} , thus $L_{SN} = L_{SN'}$.

□

Corollary 3 (Language inclusion)

Let us consider a system net $SN = (PN, M_{init}, M_{final})$, such that $PN = (P, T, F, l)$, and $\forall t \in T : (PN, M_{final}) \not\models t$ (PN, M), i.e., there is no transition enabled in M_{final} . Then let us apply Algorithm 3 and to obtain a free-choice system net $SN' = (PN', M_{init}, M_{final})$ with the same initial and final markings. Suppose that $BPMN_{model}$ is a result of applying Algorithm 2 to SN' . Then $L_{SN} \subseteq L_{BPMN_{model}}$.

Proof. Let TS, TS', TS_{BPMN} be reachability graphs of SN, SN' , and $BPMN_{model}$ respectively. $L_{SN} = L_{SN'}$ by Corollary 2. According to Corollary 1 if SN' doesn't contain any state, in which no transition can be enabled, except M_{final} , then $L_{SN'} = L_{BPMN_{model}}$. But under hypothesis of this corollary TS (and consequently TS') may contain states, in which no transition can be enabled, and which are not final. Also note that SN' may contain additional states (see the proof of Theorem 3), which represent the reduced behavior of SN , among them there may be states without outgoing transitions. Hence, $L_{BPMN_{model}}$ may contain additional traces.

□

Corollary 4 (Language equivalence for empty final marking) Suppose a BPMN model $BPMN_{model}$ was constructed from a system net $SN = (PN, M_{init}, M_{final})$, where $PN = (P, T, F, l)$, using Algorithm 2. If $\forall p \in P : M_{final}(p) = 0$, then $V_{BPMN_{model}} = L_{SN}$. In other words, the set of valid sequences coincide with the language of the system net.

Proof. As it follows from Theorem 2 for every marking M of a system net SN there is a marking M' in $BPMN_{model}$, such that for every position p , holds that $M(p) = M'(\mathcal{F}(p))$ and vice versa. In a system net, such that for every node of this net there is a path from the source place to this node, and in a BPMN model no node can fire in an empty marking, hence, the theorem is proven. □

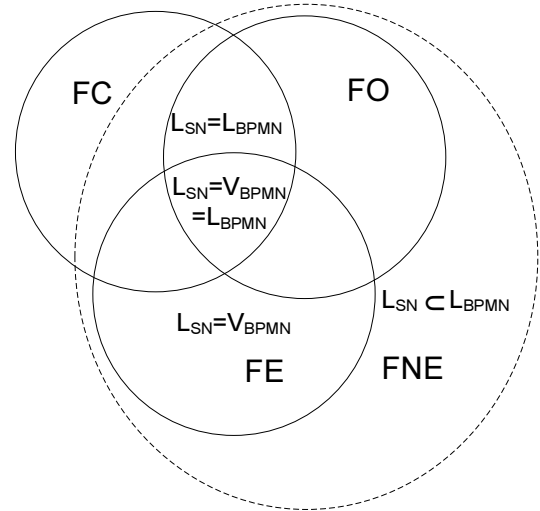

Fig. 27: Relations between languages for system nets and corresponding BPMN models. FC is a class of free-choice system nets. FNE - a class of system nets, for which no transitions are enabled in final markings. A system net belongs to the class FE , iff the final marking is the empty marking. FO is a class of system nets, for which their final markings are the only markings with no transitions enabled.

Fig. 27 summarizes theoretical results presented above: it shows relations between languages of system nets and corresponding BPMN models depending on the type of system nets.

Note that if the initial system net contains transitions with no incoming arcs (unconnected transitions), these transitions will be enabled in any reachable marking of this net. Such nets don't meet the sufficient condition for the language inclusion, i.e., some transitions are always enabled in the final marking.

4 From various process notations to BPMN models

In this section other process modeling formalisms used within process mining techniques, such as causal nets and process trees, will be introduced. Basic ideas of conversion algorithms will be given.

4.1 Transforming causal nets to BPMN models

Causal nets are known to be suitable for the representation of discovered process models. Often used for process mining (see e.g. the Heuristic miner [36]), causal nets tend to be unclear for the majority of process analysts. Although an algorithm for the conversion of causal nets to Petri nets was already presented in [6], conversions from causal nets to BPMN models should take into account the free-choice nature of BPMN models.

Causal nets are represented by activities and their bindings: each activity has a set of input and a set of output bindings (pre and post conditions). Let us consider a causal net of a booking process shown in Fig. 28. The start activ-

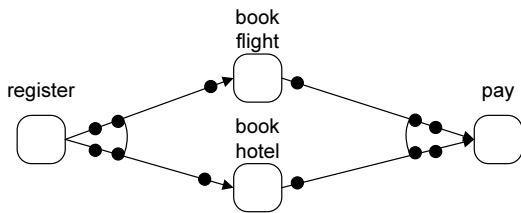

Fig. 28: Causal net of a booking process

ity *register* has only empty input binding. There are three possible output bindings for this activity: $\{book\ flight\}$, $\{book\ hotel\}$, and $\{book\ flight, book\ hotel\}$. These bindings imply that activity *register* is followed by activity *book flight*, or activity *book hotel*, or activities *book flight* and *book hotel*. The end activity *pay* has an empty output binding and three possible input bindings, i.e., activity *pay* is preceded by *book flight* and *book hotel* activities, or *book flight* activity, or *book hotel* activity.

While each activity of a causal net is converted to a BPMN model activity, bindings are represented in terms of gateways. If some activity has multiple input (output) bindings, a special exclusive gateway is created, if some binding contains more than element, a parallel gateway should be added.

In case causal net has many start or end nodes, unique start/end nodes are added to simplify the conversion to a BPMN model.

The result of the causal net (Fig. 28) conversion is presented in Fig. 29.

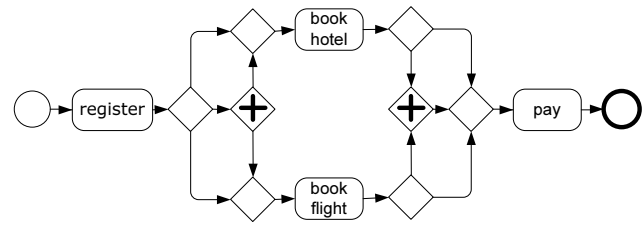

Fig. 29: BPMN model constructed from the causal net example (Fig. 28)

It is important to mention that causal nets provide *declarative* description of the process behavior while BPMN has a *local firing rules semantics*. This means that “unsound” BPMN models may be obtained as a result of conversion.

4.2 Converting process trees to BPMN models

Process trees are often obtained as a result of applying process discovery algorithms (e.g. Inductive miner [26] or Genetic miner [15]). In this subsection basic transformations for constructing a BPMN model from a given process tree will be proposed. Although process trees can be represented as system nets, and system nets in their turn can be converted to BPMN models using algorithms introduced above, a direct conversion algorithm gives an ability to consider additional perspectives during the conversion. Moreover, the BPMN standard natively supports such modeling elements as OR-join/merge. Hence, there is no need to convert these constructions to problematic, unreadable process models. Process trees were proposed in [26] and defined as direct acyclic graphs with branch and leaf nodes. Each branch node has outgoing edges and is considered to be an operator node, leaf nodes don't have outgoing edges and stand for atomic activities.

Transformation rules are applied inductively, starting from the root node. For each branch node the transformation depends on a node type, each leaf node is transformed to an activity or BPMN model event. We consider the following basic operators: sequence, exclusive/inclusive/deferred (event-based) choice, exclusive/deferred (event-based) loop and parallel execution. Note that during this transformation an extended set of BPMN elements is used. Transformation rules for each type of a branch node are presented in Tab. 2.

5 BPMN model simplification

In this subsection BPMN model transformations are presented. These transformations allow us to reduce the size of

Branch node	BPMN model
sequence $A_1 / A_2 / \dots / A_n$	
exclusive choice $A_1 / A_2 / \dots / A_n$	
inclusive choice $A_1 / A_2 / \dots / A_n$	
deferred choice $A_1 / A_2 / \dots / A_n$	
exclusive loop $A_1 / A_2 / A_3$	
deferred loop $A_1 / A_2 / A_3$	
parallel execution $A_1 / A_2 / \dots / A_n$	

Table 2: Process tree to BPMN conversion

target BPMN models. Similar Petri nets and YAWL reduction rules have already been presented in [18, 29, 38] and can be applied to BPMN constructions as well.

1. Removing silent activities. In contrast to Petri nets BPMN models allow connecting arbitrary activities and gateways, thus activities, which are not labeled, may be removed (Fig. 30). Note that all the activities constructed

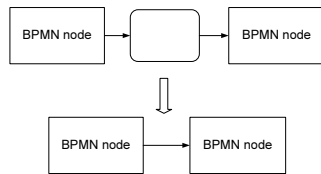

Fig. 30: Removing silent activities

during an execution of Algorithm 2 have exactly one incoming and exactly one outgoing sequence flow.

2. Reducing gateways. Sequential gateways of the same type, serving as join and split routers, can be reduced (Fig. 31).

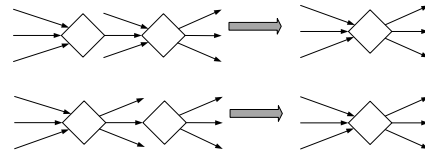

Fig. 31: Reducing gateways of the same type

3. Merging activities and gateways. According to the semantics of BPMN, activities can be merged with preceding and following gateways of the right type (Fig. 32).

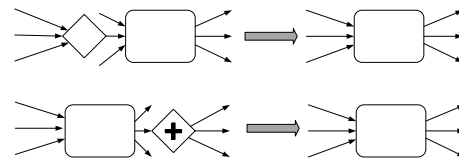

Fig. 32: Merging activities with preceding exclusive join and following parallel split gateways

6 Mapping conformance and performance info onto BPMN models

Process mining is not limited to discovery, but also offers conformance checking and enhancement techniques. To apply existing replay methods, which will allow us to obtain detailed conformance and performance information, the initial BPMN model should first be converted to a Petri net, and after that this Petri net can be analyzed using existing techniques for Petri nets.

6.1 Converting BPMN models to Petri nets

BPMN models presented in this paper are based on the core subset of BPMN modeling elements and can be considered as workflow graphs. Every node of a workflow graph can be simply converted to a corresponding Petri net pattern (Fig. 33) by the algorithms, presented in [2] and [19].

Note that according to [19] some preliminary transformations should be applied to a BPMN model: each gateway and activity, containing multiple inputs and outputs, should be splitted. Also note that this basic conversion preserves semantics and guarantees *bisimilarity* between a BPMN model and a target Petri net due to the correspondence between BPMN sequence flows and workflow net places: $Map : SF \rightarrow P$, i.e., for each sequence flow of the BPMN model

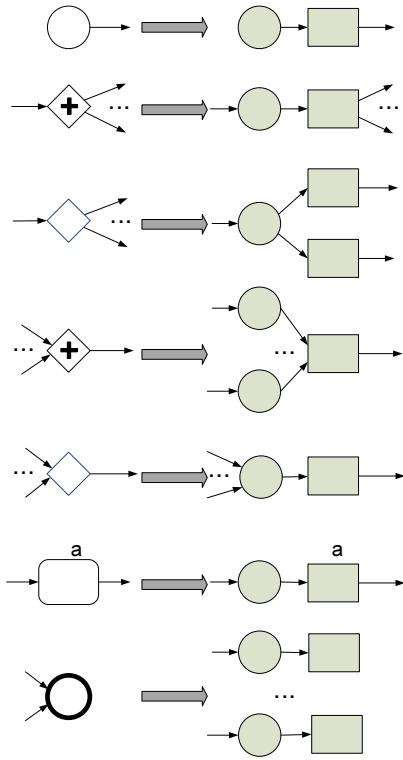

Fig. 33: BPMN to Petri net conversion patterns

there is a corresponding place in the target Petri net. The proof of *bisimulation* is straightforward.

6.2 Mapping conformance and performance info

The *bisimulation* relation defines a mapping between states of an initial BPMN model and a target Petri net, and gives us an ability to visualize performance and conformance information, which is attached to some states of the Petri net, within the initial BPMN model.

To give an example, which shows how a conformance information can be visualized within a BPMN diagram, we have to introduce the notion of alignment. Alignment establishes log and model similarities and discrepancies by defining correspondence between moves on log and moves (firings) on model.

Let A_L be a set of log events. Let also $PN = (P, T, F, l)$ be a labeled Petri net, where $l : T \rightarrow A_M$, and A_M is a set of model events. Let \gg be a special event, such that $\gg \notin (A_L \cup A_M)$.

Alignment step is a pair (x, y) :

- (x, y) is a *move on log* if $x \in A_L, y = \gg$,
- (x, y) is a *move on model* if $x = \gg, y \in A_M$,
- (x, y) is a *move in both* if $x \in A_L, y \in A_M$,
- (x, y) is an *illegal move* if $x = \gg, y = \gg$.

An *alignment* is a sequence of *alignment steps*, that are not *illegal moves*.

Now let us consider a BPMN model of a booking process (Fig. 34).

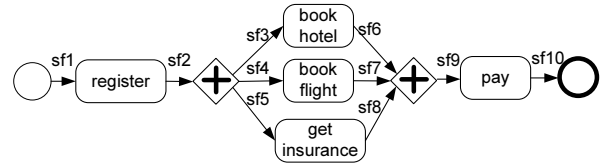

Fig. 34: A BPMN of a booking procedure

Let us apply the conversion algorithm to obtain a Petri net with places, corresponding to BPMN sequence flows. The result is shown in Fig. 35.

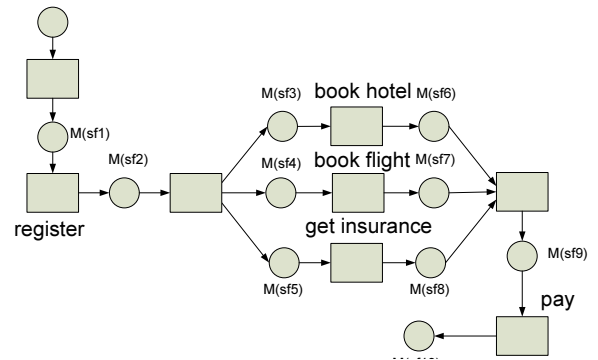

Fig. 35: A Petri net constructed from the BPMN model presented in Fig. 34

To illustrate enhancement of a process model with conformance and performance information, an event log consisting of only one trace, containing insurance cancellation event, is considered (Tab. 3).

Case ID	Event	Timestamp
1	register	2014-12-24 09:30:01:727
1	book flight	2014-12-24 09:43:23:353
1	book hotel	2014-12-24 09:52:14:252
1	cancel insurance	2014-12-24 09:52:20:732
1	pay	2014-12-24 10:04:24:754

Table 3: An event log of a booking process with cancellation.

To construct an alignment this log should be represented as a multiset of traces:

$$L = [\langle \text{register}, \text{book flight}, \text{book hotel}, \text{cancel insurance}, \text{pay} \rangle^1].$$

The result of application of the algorithm [11], which finds an optimal (with the minimal number of log only and model only moves) alignment is presented below (the names of events are represented by their first letters, firing of silent transitions are denoted as τ). The first row represents log moves, while the second row stands for model firings:

$$\gamma = \begin{array}{c|c|c|c|c|c|c|c|c|c|} \gg & r & \gg & b f & \gg & b h & c i & \gg & p & \\ \hline \tau & r & \tau & b f & g i & . b h & & \gg & \tau & p \end{array}$$

Such alignments can be used to enhance existing BPMN models with conformance information (Fig. 36).

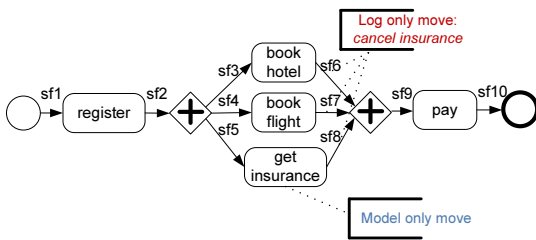

Fig. 36: A BPMN model annotated with conformance information.

Note that the relation between states of the models allows us to attach log move information to sequence flows, which correspond to a concrete state of the BPMN model - the state, in which log move is performed. This BPMN model can be enriched with a performance information (such as activity execution times) obtained as a result of alignment-based replay (Fig. 37). Note that different types

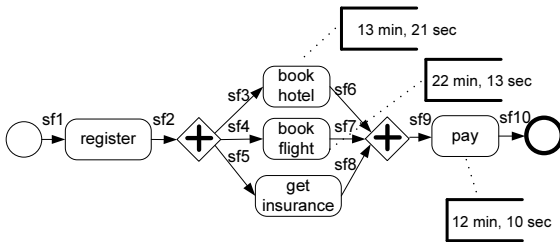

Fig. 37: A BPMN model annotated with performance information.

of performance information, such as average, minimal, maximal, relative execution times can be added to a diagram.

7 Tool support

The techniques presented in this paper have all been implemented in ProM [35], an open source framework for process mining. Let us consider BPMN packages architecture and their functionality in ProM (Fig. 38).

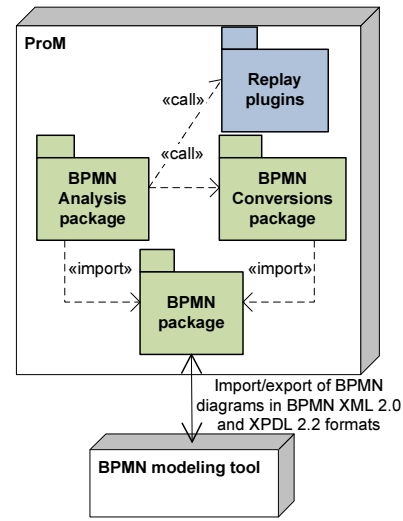

Fig. 38: BPMN packages architecture

The core BPMN package provides basic interfaces for working with BPMN models, including import and export of BPMN diagrams in BPMN XML [30] and XPDL 2.2 [37] formats. The BPMN conversions package depends on the core BPMN package and provides the ability to convert Petri nets, causal nets [6] and process trees [8] to BPMN, thus supporting the discovery of BPMN models. Besides that the resource and the data flow perspectives can be discovered as well: data Petri nets obtained using the data-aware process mining algorithm [27] can be used to create BPMN models with data perspective, process trees with resources can be converted to BPMN model with lanes. The BPMN Analysis package is constructed on top of the core BPMN and the BPMN conversions packages and its plugins can be used to enhance BPMN models with additional conformance and performance information.

To illustrate this we consider two main use cases for working with BPMN in ProM.

Use case 1 (Discovering BPMN processes): The user discovers a BPMN model by applying discovery and BPMN conversions plugins, then this model can be exported to an external BPMN modeling or execution tool (Fig. 39).

Use case 2 (Analyzing BPMN processes): The user loads a BPMN model from an external BPMN modeling tool, then, by applying the BPMN Analysis package, converts this model into a Petri net, replays a log to obtain conformance and performance information, and enhances the BPMN diagram with this information (Fig. 40).

More details about the functionality of the BPMN packages in ProM can be found at [22].

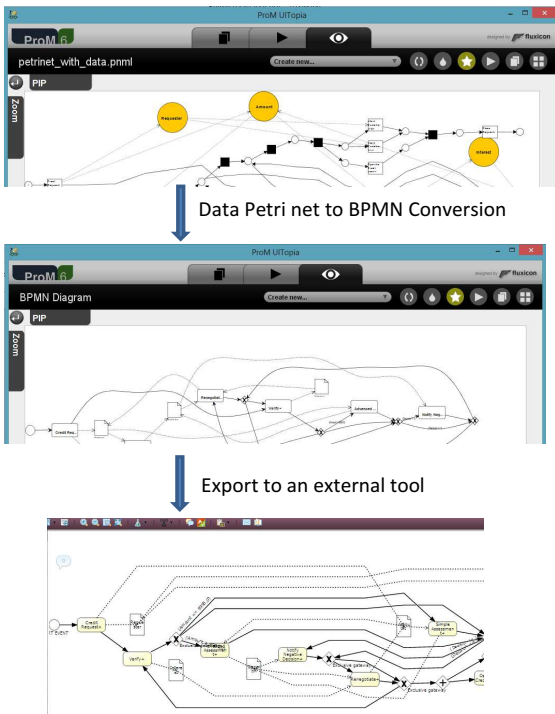

Fig. 39: Discovering a BPMN model with data

8 Case studies

In this section we present case studies based on the event logs produced by information systems from different domains.

First we consider a complex ticket reservation system from the traveling and transportation domain. This system belongs to a class of *Computer Reservation Systems (CRS)* and is used for booking all types of touristic products such as hotels, flights, cars, excursions, activities, trains, etc. It integrates multiple Global Distribution Systems (GDS) for pre-sales (search, reservation) and sales (book, pay) processes. The system can be accessed by normal customers through a web interface or by expert users, e.g. travel agency or system support, through a special rich client interface. Independently of the client interface, calls to the backend of the system are logged in order to track the system state and performance, to gather statistics and to analyze the user behavior and make estimations and predictions⁴. These logs contain the timestamps, identifiers of the business cases (unique identifier of the reservation) and also different business attributes describing user operations (e.g. search, quote, book, pay), travel directions (e.g. origin, destination, booking code), traveling time (e.g. start and end date). For our experiments we took a log of the ticket reservation system, which contains 94 cases, 50 events, and describes the sys-

⁴These logs exclude user and commercial sensible information like names, credit cards and invoices.

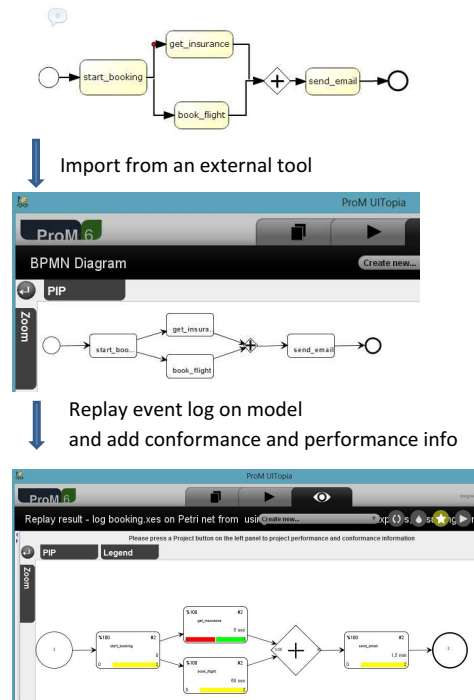

Fig. 40: Analysis of a BPMN model

tem behavior during four hours of its work. This event data is perfectly suitable for applying process mining, since we identify the case by reservation id, events by a subset of business attributes and order of events by a timestamp. For more information about these event logs please refer to [32, 33].

The other system being analyzed is a *Tracker System (TS)* used for management of kanban and scrum software development processes. The history of the system usage contains short traces (the average number of events per trace is 3.5). Each trace can be identified by a unique number, it corresponds to a concrete task for developers, and represents a sequence of task states, such as “Open”, “In Progress”, “Resolved”, “Reopened” and “Closed”. These task states are considered as events, timestamps are used to order them.

Event logs produced by six different anonymous municipalities [13, 14] within the *CoSeLoG* project in the Netherlands were analyzed as well. These event logs contain information about executions of a permit application process. The original event logs were reduced in order to speed up the discovery techniques applied: the number of traces for these six logs varies from 17 to 324, the number of different events (event classes) is 22 for the log, which contains receiving phase only, and between 69 and 176 for the other event logs. For the log corresponding to the receiving phase the mean case duration time is 3.1 days, for the other logs the mean case duration time lies between 21.4 days and 49.2 weeks.

8.1 Discovering BPMN models

In this subsection we show fragments of the CRS log and describe models discovered from this log.

A short typical fragment of an event log is shown in Tab. 4. Every log entry contains fields such as reservation id, an event name, a timestamp, a booking code and a notification. An event name is a shortcut built from a user operation and of a product type, e.g. “T1-HF-H:TES” means that user does operation “search” for a product type “Hotel”. The booking code identifies the location, e.g. “BER” means Berlin, Germany. Thus, in the example in Tab. 4 we show two reservations: “390234516” is a search for available hotels in Berlin and “390235717” is a reservation for a double room in a concrete hotel in Berlin.

Further in this subsection we use different discovery (Heuristic [36], Alpha [10], and Inductive [26] miners) to construct process models from the event log. As a result of applying discovering methods we obtain Petri nets, causal nets and process trees. All these models are converted to BPMN using algorithms presented before. The log of the booking process was filtered: the parts, which contain only positive or only negative cases (cases with booking error events) were identified. Moreover, since the booking flight procedure differs from other bookings, the log was also filtered by containing booking flight event.

Let us consider models constructed from a filtered log containing only positive traces without flight booking procedure⁵; Fig. 41 illustrates a Petri net discovered with Alpha miner [10] for this log. The BPMN model constructed for

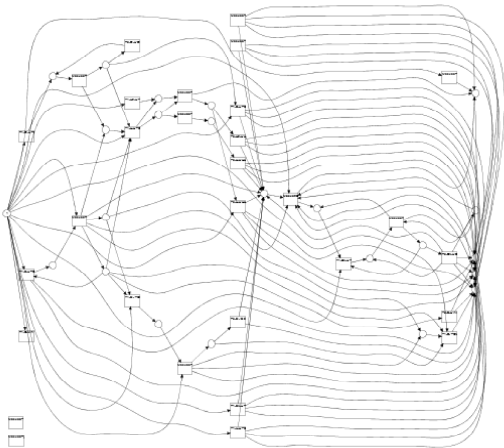

Fig. 41: A Petri net discovered by the Alpha miner from the event log

the given Petri net (Fig. 41) by the conversion algorithm is shown in Fig. 42. Note that in this case the amount of rout-

⁵All the models presented in this section are discovered using ProM framework [35]

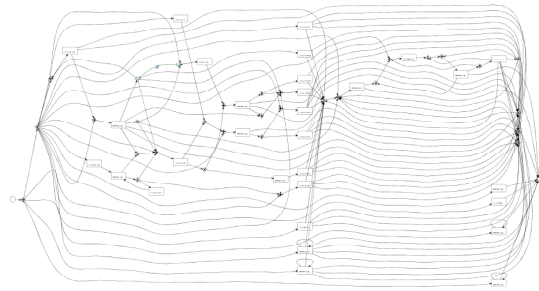

Fig. 42: A BPMN model constructed from the Petri net presented in Fig. 41

ing elements (gateways) in the BPMN model is comparable with the number places of the initial Petri net, the number of activities coincides with the number of transitions. Also note that thanks to Algorithm 1 all the activities of the target BPMN model are on paths from the start event to end events.

Now let us consider a causal net (Fig. 43) discovered using the heuristic miner algorithm [36].

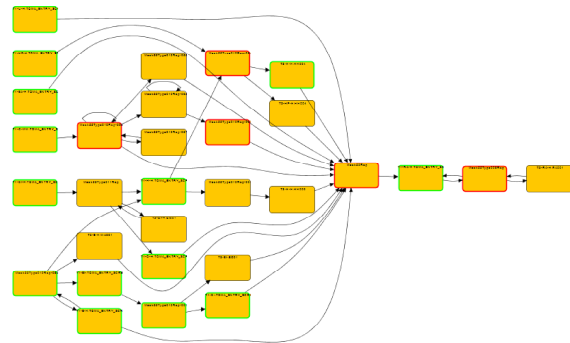

Fig. 43: A causal net discovered by heuristic miner from the event log

This causal net can be converted to a BPMN model (Fig. 44) using the conversion algorithm presented before. The BPMN model reveals the operational semantics of the

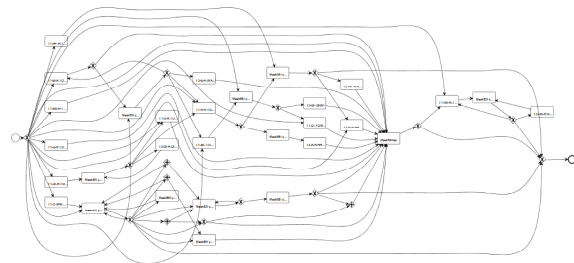

Fig. 44: A BPMN model constructed from the causal net presented in Fig. 43

process. Fig. 43 is not explicitly showing the routing constructions, but the BPMN model does. Now we will con-

Reservation ID	Event	Timestamp	Booking Code	Notification
390234516	T1-HF-H:TES	2013-12-18 08:36:00:570	BER	
390234516	M55Type010Rsp-034	2013-12-18 08:36:04:717		998
390234516	T3-HF-H:HH004	2013-12-18 08:36:09:337	BER	
390234516	M52Rsp	2013-12-18 08:36:09:337		998
390235717	T1-BA-H:TES	2013-12-18 08:36:12:155	BER45010 DH	
390235717	M52Rsp	2013-12-18 08:36:18:397		712

Table 4: Event log from a CRS.

consider a process tree discovered by the Inductive miner [26] (Fig. 45). The corresponding Petri net is presented in

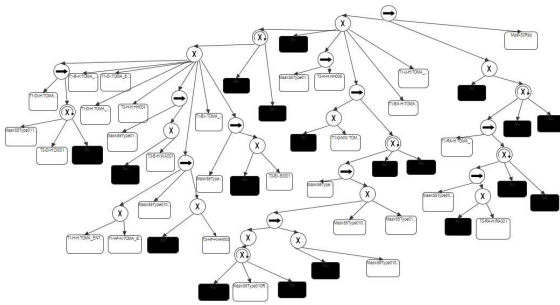

Fig. 45: A process tree discovered by inductive miner

Fig. 46. The BPMN model constructed from the process

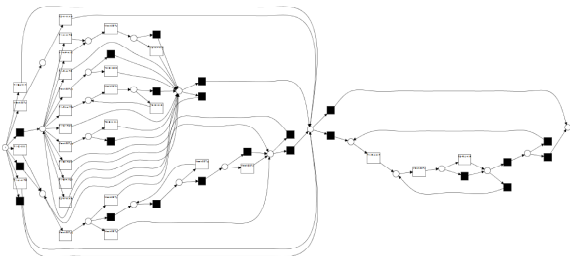

Fig. 46: A Petri net constructed from the process tree shown in Fig. 45

tree by the conversion algorithm doesn't contain any silent activities (Fig. 47).

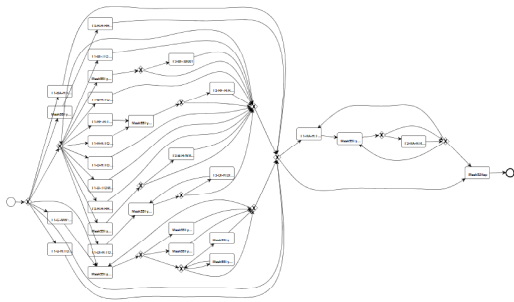

Fig. 47: A BPMN model, which corresponds to the process tree (Fig. 45)

Moreover, the number of gateways is significantly less than the amount of places in the corresponding Petri net (Fig. 46). Note that the process, discovered by the Inductive miner, is compactly presented in terms of BPMN.

8.2 Comparative analysis of the models discovered

In this subsection we make a comparative analysis of processes models discovered from the event logs and corresponding BPMN models obtained as a result of conversions using various metrics [34]. We will consider the following metrics: the number of nodes, the diameter (the maximal length of a shortest path from a start node to a node of the graph) and density (ratio of the total number of arcs to the maximum possible number of arcs of the graph).

Different process mining algorithms give process models with different characteristics. Of course the set of considered process mining algorithms is far from complete. But our aim is to analyze the conversion techniques, thuswise we have selected algorithms, representing the entire classes of discovery approaches, which produce process models with certain properties. The Alpha mining algorithm is not tailored towards handling noisy real-life logs and discovers unstructured process models, meanwhile the Inductive miner deals with noise and produces structured models. The Heuristic miner was chosen as a technique, which allows us to construct causal nets from event logs.

Let us consider a free-choice system net $SN = (PN, M_{init}, M_{final})$, where $PN = (P, T, F, l)$ is a labeled Petri net, and a BPMN model $BPMN_{model} = (N, A, G_{XOR}, G_{AND}, e_{start}, E_{end}, SF, \lambda)$, obtained by the conversion algorithm from this net. The number of activities equals to the number of non-silent transitions: $|A| = |\{t \in T : t \lambda(t) \neq \tau\}|$. In the worst case the number of gateways $|G_{XOR} \cup G_{AND}|$ is comparable to the number of places plus the number of transitions: $|P| + |T|$, since every place can produce an XOR-join, and in the worst case the number of AND-join gateways and the number of XOR-split gateways are both comparable to $\lfloor |T|/2 \rfloor$. Note that AND-split gateways will be deleted during the simplification of the BPMN model. In the best case (for a sequential control

flow) a BPMN model will not contain any gateways. Also note that all the constructions produced during the transformation of arbitrary Petri nets to free-choice nets will contain only silent transitions and related places.

For a BPMN model constructed from a causal net the number of activities equals the number of causal net activities. The number of gateways is determined by input and output bindings of the activities.

A BPMN model constructed as a result of a process tree conversion contains activities corresponding to non-silent process tree leafs, every branch node of the process tree will be converted to a routing construction of the BPMN model, containing zero (in the case of a sequential control flow), one, or more routing nodes. Note that some routing nodes might be merged during the simplification procedure.

To estimate the number of nodes of process models discovered from the real-life event logs let us consider Tab. 5. The rows in this and other tables are ordered by the number of process models nodes.

Log traces	Heuristic miner (C-net/ BPMN ⁶)	Alpha miner (Petri net ⁷ / BPMN ⁶)	Inductive miner (Proc. tree/ Petri net ⁷ / BPMN ⁶)
CSLG1	176 / 176,143,128	176,372 / 176,340,120	261 / 235,49 / 176,25,0
CSLG2	134 / 134,58,56	134,238 / 134,159,54	273 / 223,89 / 134,42,0
CSLG3	93 / 93,58,70	93,198 / 93,153,42	219 / 173,78 / 93,35,0
CSLG4	75 / 75,49,52	75,143 / 75,101,33	151 / 120,50 / 75,21,0
CSLG5	68 / 68,58,58	68,181 / 69,159,55	84 / 77,9 / 68,3,0
CSR1	30 / 30,14,4	30,23 / 30,18,13	130 / 100,53 / 30,25,0
CSR2	30 / 30,14,5	30,13 / 30,5,7	102 / 81,43 / 30,20,0
CSR3	27 / 27,10,4	27,28 / 27,24,13	107 / 82,52 / 27,24,2
CSLG6	22 / 22,8,6	22,24 / 22,14,12	54 / 41,19 / 22,7,0
CSR4	21 / 21,6,4	21,23 / 21,18,11	88 / 67,41 / 21,18,0
TS	5 / 5,7,0	5,7 / 5,5,4	15 / 9,5 / 5,3,0

Table 5: Number of nodes of process models discovered from the event logs

The first column refers to the event logs used: six event logs, originating from municipal processes, of the *CoSeLoG* project (denoted as CSLG1 - CSLG6), the logs of *CSR* (Computer Reservation System) with various types of filtering applied⁸, and the logs of *TS* (Tracking system). Each of the other columns mentions the number of nodes of the initial process model constructed by a discovery algorithm and the number of nodes of the BPMN model obtained as

⁶For BPMN models the number of activities, XOR gateways and AND gateways are specified, the values are separated by a comma.

⁷For Petri nets the number of transitions and places are specified and separated by a comma.

⁸By CSR1, CSR2, CSR3 and CSR4 we denote event logs of the Computer Reservation System, containing only positive cases and/or booking flight event.

a result conversion (for Petri nets and BPMN models the number of transitions, places and the number of activities, XOR gateways, AND gateways are specified, the values are separated by a comma).

This table shows that the number of BPMN model nodes depends on the properties of the initial Petri net: BPMN models constructed for structured Petri nets are more compact (see the Inductive miner column). This holds due to the fact that BPMN language allows simplifications, such as silent nodes deletion (structured models usually contain silent nodes) and gateways reduction, which is also applicable to structured nets, if some blocks can be merged. For non-structured Petri nets (see the Alpha miner column) the number of BPMN model nodes is comparable or even greater than the number of nodes of the initial Petri net. Also according to the theoretical observations the number of nodes of a BPMN model is not always lower than the number of nodes of the initial causal net, since BPMN models may have routing nodes.

Similarly let us estimate the density of the models discovered (Tab. 6). Graph density is defined as $D = |E| / (|V| * (|V| - 1))$, where E is a set of edges and V is a set of nodes. Density shows the relation between the real number of edges and the maximum possible number of edges in the graph.

Log traces	Heuristic miner (C-net/ BPMN)	Alpha miner (Petri net/ BPMN)	Inductive miner (Petri net/ BPMN)
CSLG1	0.01 / 0.004	0.005 / 0.004	0.005 / 0.01
CSLG2	0.01 / 0.005	0.005 / 0.005	0.005 / 0.01
CSLG3	0.02 / 0.01	0.01 / 0.01	0.005 / 0.02
CSLG4	0.02 / 0.01	0.01 / 0.01	0.01 / 0.02
CSLG5	0.02 / 0.005	0.005 / 0.005	0.01 / 0.02
CSR1	0.07 / 0.04	0.05 / 0.04	0.01 / 0.04
CSR2	0.07 / 0.04	0.03 / 0.05	0.01 / 0.04
CSR3	0.06 / 0.04	0.04 / 0.03	0.01 / 0.03
CSLG6	0.07 / 0.05	0.04 / 0.04	0.03 / 0.06
CSR4	0.08 / 0.05	0.05 / 0.04	0.01 / 0.04
TS	0.5 / 0.2	0.19 / 0.12	0.1 / 0.16

Table 6: Density of the models discovered

The density of the BPMN models constructed from unstructured Petri nets is comparable with the density of these Petri nets (see the Alpha miner column). The density of structured Petri nets is larger than the density of corresponding BPMN models (see the Inductive miner column) due to reductions applied in the case of structured processes. The density of causal nets is certainly greater than the density of corresponding BPMN models, since novel gateways, which connect process activities, are added.

Now let us consider the diameter - the maximal length of a shortest path from a start node to a node of the graph. The results presented in the Tab. 7 show that the statements valid for the number of nodes parameter are also true for the

diameter: BPMN models corresponding to structured Petri nets are more compact than the initial models.

Log traces	Heuristic miner (C-net/ BPMN)	Alpha miner (Petri net/ BPMN)	Inductive miner (Petri net/ BPMN)
CSLG1	12 / 24	17 / 21	37 / 14
CSLG2	39 / 53	49 / 42	76 / 23
CSLG3	23 / 38	37 / 26	71 / 23
CSLG4	25 / 32	39 / 34	56 / 16
CSLG5	18 / 35	13 / 17	16 / 5
CSR1	3 / 7	6 / 10	20 / 6
CSR2	3 / 7	5 / 7	8 / 9
CSR3	6 / 12	11 / 13	39 / 14
CSLG6	6 / 11	13 / 13	25 / 7
CSR4	5 / 8	10 / 11	41 / 12
TS	2 / 5	3 / 6	5 / 4

Table 7: Diameter of the process models discovered from the event logs

In this subsection we have evaluated the discovered process models using metrics, such as the number of nodes, the density and the diameter. The results show that the compactness of the result BPMN models depends considerably on characteristics of the initial models.

Another important issue in the context of our practical case studies presented in this subsection was the understandability of the process mining output format. The software architects and designers of the touristic system were especially interested in getting the results in the BPMN format. They were familiar with BPMN and BPMN was also used in the specification and design phases of the software product for documenting the typical touristic business processes. Moreover BPMN exchange formats, such as BPMN XML [30] and XPD L 2.2 [37], give us an ability to integrate with a variety of BPMN supporting tools, thus discovered processes can be analyzed, improved or even automated using external environments. In addition BPMN offers great opportunities to add other perspectives, such as data and resource information, results of conformance and performance analysis. This way the analyst can obtain a holistic view on the processes discovered.

8.3 Comparing discovered and manually created BPMN models

To compare the models discovered from the event log with manually created BPMN models we analyzed the Signavio model collection, which contains a variety of BPMN models from different domains. We took only flat models represented by start and end events, tasks, gateways and sequence flows. Currently the Signavio model collection contains 4900 of such models. For these models we calculated the structural characteristics: number of nodes, density, and diameter (Tab. 8).

	Number of nodes	Density	Diameter
Maximal	58.00	0.87	25
Mean	20.76	0.10	8
Minimal	6.00	0.00	1

Table 8: Characteristics of process models from the Signavio model collection

Comparing these results with the measurements presented in the tables 5 and 7 one may conclude that models drawn manually (excluding models discovered from the small *TS* log) are usually more compact than those, which were automatically discovered using the well-known discovery and conversion algorithms presented in this paper. Also these observations show that BPMN models created manually have higher density than automatically discovered BPMN models. The results obtained for the Signavio model collection is a consequence of the fact that business process analysts and engineers are used to work with more structured models, so an algorithm for subprocesses discovery is needed. An algorithm for the construction of BPMN subprocesses based on a log clustering and filtering was proposed in [17]. However, more research is needed to compare hand-made and discovered models.

9 Conclusions and future work

This paper provides a solid basis for using BPMN in process mining. The results presented in the paper concentrate on the control flow perspective, as it is usually considered to be the main perspective. It is the starting point for extending with additional perspectives during an enhancement of the process model discovered from an event log.

In this paper we used various control flow discovery algorithms. These produce Petri nets, causal nets, process trees, etc. Few algorithms produce directly a BPMN model. Hence, we developed various conversion algorithms to mine BPMN. Petri nets, process trees and causal nets discovered from a real-life event log were compared with the corresponding BPMN models on the basis of three process metrics. Moreover, these metrics were applied to measure the difference between BPMN models, which were created by analysts, and BPMN models retrieved as a result of process discovery algorithms. An approach for enhancing a BPMN model with additional conformance and performance information was proposed as well.

The results presented in the paper can be used to retrieve BPMN models out of event logs and verify them against event logs. This work can be considered as a first step towards the development of more advanced process discovery methods, including novel perspectives.

As was shown in Subsection 8.3 more structured process models are needed, thus methods for subprocesses discovery should be introduced. In comparison with the approach

presented in [17] we plan to build a method on top of the decomposition techniques [1, 23, 24] to obtain structural models, preserving behavior recorded in an event log.

References

1. Aalst, W.: A General Divide and Conquer Approach for Process Mining. In: Federated Conference on Computer Science and Information Systems (FedCSIS 2013), pp. 1–10 (2013)
2. Aalst, W., Hirsenschall, A., Verbeek, H.: An Alternative Way to Analyze Workflow Graphs. In: Proceedings of the 14th International Conference on Advanced Information Systems Engineering (CAiSE'02), vol. 2348, pp. 535–552 (2002)
3. van der Aalst, W.M.P.: The application of Petri nets to workflow management. *Journal of Circuits, Systems, and Computers* **8**(1), 21–66 (1998)
4. van der Aalst, W.M.P.: *Process Mining - Discovery, Conformance and Enhancement of Business Processes*. Springer (2011)
5. van der Aalst, W.M.P.: Process mining. *Communications of the ACM* **55**(8), 76–83 (2012)
6. van der Aalst, W.M.P., Adriansyah, A., van Dongen, B.F.: Causal nets: A modeling language tailored towards process discovery. In: CONCUR, *Lecture Notes in Computer Science*, pp. 28–42. Springer (2011)
7. van der Aalst, W.M.P., Adriansyah, A., van Dongen, B.F.: Replaying history on process models for conformance checking and performance analysis. *Wiley Int. Rev. Data Min. and Knowl. Disc.* **2**(2), 182–192 (2012)
8. van der Aalst, W.M.P., Buijs, J.C.A.M., van Dongen, B.F.: Towards improving the representational bias of process mining. In: IFIP International Symposium on Data-Driven Process Discovery and Analysis (SIMPDA 2011), *Lecture Notes in Business Information Processing*, vol. 116, pp. 39–54. Springer-Verlag, Berlin (2012)
9. van der Aalst, W.M.P., Rubin, V.A., Verbeek, H.M.W., van Dongen, B.F., Kindler, E., Günther, C.W.: Process mining: A two-step approach to balance between underfitting and overfitting. *Software and Systems Modeling* **9**(1), 87–111 (2010)
10. van der Aalst, W.M.P., Weijters, A.J.M.M., Maruster, L.: Workflow mining: Discovering process models from event logs. *IEEE Transactions on Knowledge and Data Engineering* **16**(9), 1128–1142 (2004)
11. Adriansyah, A., van Dongen, B.F., van der Aalst, W.M.P.: Conformance checking using cost-based fitness analysis. In: EDOC, pp. 55–64. IEEE Computer Society (2011)
12. Bergenthum, R., Desel, J., Lorenz, R., Mauser, S.: Process mining based on regions of languages. In: International Conference on Business Process Management (BPM 2007), *Lecture Notes in Computer Science*, vol. 4714, pp. 375–383. Springer (2007)
13. Buijs, J.: Environmental permit application process, coselog project (2014)
14. Buijs, J.: Receipt phase of an environmental permit application process, coselog project (2014)
15. Buijs, J., Dongen, B., Aalst, W.: A Genetic Algorithm for Discovering Process Trees. In: IEEE Congress on Evolutionary Computation (CEC 2012), pp. 1–8. IEEE Computer Society (2012)
16. Carmona, J., Cortadella, J.: Process mining meets abstract interpretation. In: ECML/PKDD 210, *Lecture Notes in Computer Science*, vol. 6321, pp. 184–199. Springer (2010)
17. Conforti, R., Dumas, M., Garcia-Baneulos, L., La Rosa, M.: Beyond tasks and gateways: Discovering BPMN models with subprocesses, boundary events and activity markers. In: International Conference in Business Process Management (BPM), pp. 101–117. Springer, Haifa, Israel (2014)
18. Desel, J., Esparza, J.: *Free Choice Petri Nets*. Cambridge University Press, New York, NY, USA (1995)
19. Favre, C., Fahland, D., Völzer, H.: The relationship between workflow graphs and free-choice workflow nets. *Information Systems* **47**, 197 – 219 (2015)
20. Günther, C.W., van der Aalst, W.M.P.: Fuzzy mining: Adaptive process simplification based on multi-perspective metrics. In: International Conference on Business Process Management (BPM 2007), *Lecture Notes in Computer Science*, vol. 4714, pp. 328–343. Springer (2007)
21. IEEE Task Force on Process Mining: Process Mining Manifesto. In: Business Process Management Workshops, *Lecture Notes in Business Information Processing*, vol. 99, pp. 169–194. Springer (2012)
22. Kalenkova, A.A., de Leoni, M., van der Aalst, W.M.P.: Discovering, analyzing and enhancing BPMN models using ProM. In: Business Process Management - 12th International Conference, BPM 2014, Haifa, Israel, September 7-11, 2014. Proceedings (2014). In press
23. Kalenkova, A.A., Lomazova, I.A.: Discovery of cancellation regions within process mining techniques. *Fundamenta Informaticae* **133**(2–3), 197–209 (2014)
24. Kalenkova, A.A., Lomazova, I.A., van der Aalst, W.M.P.: Process model discovery: A method based on transition system decomposition. In: Application and Theory of Petri Nets and Concurrency, *Lecture Notes in Computer Science*, pp. 71–90. Springer (2014)
25. Kindler, E.: On the Semantics of EPCs: A Framework for Resolving the Vicious Circle. In: International Conference on Business Process Management (BPM 2004), *Lecture Notes in Computer Science*, vol. 3080, pp. 82–

97. Springer (2004)
26. Leemans, S.J.J., Fahland, D., van der Aalst, W.M.P.: Discovering block-structured process models from event logs: A constructive approach. In: Application and Theory of Petri Nets and Concurrency, *Lecture Notes in Computer Science*, vol. 7927, pp. 311–329. Springer (2013)
 27. de Leoni, M., van der Aalst, W.M.P.: Data-aware process mining: Discovering decisions in processes using alignments. In: ACM Symposium on Applied Computing (SAC 2013), pp. 1454–1461. ACM Press (2013)
 28. Mendling, J., van der Aalst, W.M.P.: Towards EPC semantics based on state and context. In: Proceedings of Fifth Workshop on Event-Driven Process Chains (WI-EPK 2006), pp. 25–48. Gesellschaft für Informatik, Bonn, Vienna (2006)
 29. Murata, T.: Petri nets: Properties, analysis and applications. *Proceedings of the IEEE* **77**(4), 541–580 (1989)
 30. OMG: Business Process Model and Notation (BPMN), Version 2.0 (2011). URL <http://www.omg.org/spec/BPMN/2.0>
 31. OMG: OMG Unified Modeling Language 2.5. OMG, <http://www.omg.org/spec/UML/2.5/> (2013)
 32. Rubin, V.A., Lomazova, I.A., van der Aalst, W.M.P.: Agile development with software process mining. In: Proceedings of the 2014 International Conference on Software and System Process, ICSSP 2014, pp. 70–74. ACM, New York, NY, USA (2014)
 33. Rubin, V.A., Mitsyuk, A.A., Lomazova, I.A., van der Aalst, W.M.P.: Process mining can be applied to software too! In: Proceedings of the 8th ACM/IEEE International Symposium on Empirical Software Engineering and Measurement, ESEM '14, pp. 57:1–57:8. ACM, New York, NY, USA (2014)
 34. Sánchez-González, L., García, F., Mendling, J., Ruiz, F., Piattini, M.: Prediction of business process model quality based on structural metrics. In: ER, *Lecture Notes in Computer Science*, vol. 6412, pp. 458–463. Springer (2010)
 35. Verbeek, H.M.W., Buijs, J.C.A.M., van Dongen, B.F., van der Aalst, W.M.P.: ProM 6: The Process Mining Toolkit. In: Proc. of BPM Demonstration Track 2010, *CEUR Workshop Proceedings*, vol. 615, pp. 34–39 (2010)
 36. Weijters, A.J.M.M., Ribeiro, J.T.S.: Flexible heuristics miner (FHM). In: IEEE Symposium on Computational Intelligence and Data Mining (CIDM 2011), pp. 310–317. IEEE, Paris, France (2011)
 37. WFMC: XML Process Definition Language Version 2.2. Tech. Rep. WFMC-TC-1025, Workflow Management Coalition, Lighthouse Point, Florida, USA (2012)
 38. Wynn, M., Verbeek, H., van der Aalst, W.M.P., Hofstede, A., Edmond, D.: Reduction Rules for YAWL Workflows with Cancellation Regions and OR-join. *Information and Software Technology* **51**(6), 1010–1020 (2009)