

# Comparison of PID control and CRCTC for the vibrating frame problem

**Citation for published version (APA):**

Ploemen, I. H. J. (1995). *Comparison of PID control and CRCTC for the vibrating frame problem*. (DCT rapporten; Vol. 1995.143). Technische Universiteit Eindhoven.

**Document status and date:**

Published: 01/01/1995

**Document Version:**

Publisher's PDF, also known as Version of Record (includes final page, issue and volume numbers)

**Please check the document version of this publication:**

- A submitted manuscript is the version of the article upon submission and before peer-review. There can be important differences between the submitted version and the official published version of record. People interested in the research are advised to contact the author for the final version of the publication, or visit the DOI to the publisher's website.
- The final author version and the galley proof are versions of the publication after peer review.
- The final published version features the final layout of the paper including the volume, issue and page numbers.

[Link to publication](#)

**General rights**

Copyright and moral rights for the publications made accessible in the public portal are retained by the authors and/or other copyright owners and it is a condition of accessing publications that users recognise and abide by the legal requirements associated with these rights.

- Users may download and print one copy of any publication from the public portal for the purpose of private study or research.
- You may not further distribute the material or use it for any profit-making activity or commercial gain
- You may freely distribute the URL identifying the publication in the public portal.

If the publication is distributed under the terms of Article 25fa of the Dutch Copyright Act, indicated by the "Taverne" license above, please follow below link for the End User Agreement:

[www.tue.nl/taverne](http://www.tue.nl/taverne)

**Take down policy**

If you believe that this document breaches copyright please contact us at:

[openaccess@tue.nl](mailto:openaccess@tue.nl)

providing details and we will investigate your claim.

**Comparison of PID control  
and CRCTC for the vibrating  
frame problem**

WFW 95.143

Ingmar Ploemen  
id. nr. 319768  
September 29, 1995

# Comparison of PID control and CRCTC for the vibrating frame problem

I.H.J. PLOEMEN †  
M.J.G. VAN DE MOLENGRAFT †  
A.M. RANKERS ‡  
J.J. KOK †

† *Department of Mechanical Engineering, Eindhoven University of Technology, P.O. Box 513, 5600 MB Eindhoven, The Netherlands*

‡ *Department Mechatronics, Centre for Manufacturing Technology, Philips Electronics N.V., P.O.Box 218 Building SAQ 2121 NL-5600 MD Eindhoven, The Netherlands*

*Abstract:* The performance of motion systems can be badly influenced by vibrations of a flexible machine frame. In this article three different control strategies for a system with a flexible frame have been implemented and compared in simulations as well as in experiments. With a conventional PID-controller the tracking error clearly shows the vibrations of the frame. Adding frame acceleration feedforward to the PID-controller takes away the influence of the frame vibrations in the tracking error, though this leads to reduced stability margins and more vibrations of the frame itself. The performance of Computed Reference Computed Torque Control, a model based control strategy, is almost equally good, though the model used differs from the real system in some important aspects.

Key Words: Machine vibrations, control systems, stability, .....

## 1 Introduction

During the past decade, an enormous growth of high performance motion systems has taken place, ranging from small consumer products such as the compact disc player to professional IC production equipment, such as wire bonders and wafer steppers. The increasing demands on speed and performance have made mechanical vibrations increasingly important in the overall performance of these systems and effect both servo stability and set point response.

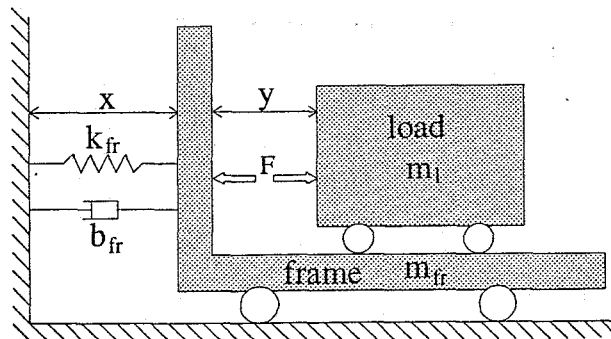

Figure 1: System with limited stiffness and mass of the stationary part

One of the possible causes of mechanical vibrations, i.e. limited stiffness and mass of the stationary machine frame (Figure 1), will be considered in this article. When a step response of the position  $y$  between load and frame is asked, the reaction force will cause vibrations of the frame which will also infect the error in  $y$  (Figure 2).

Two types of PID-controllers as well as Computed Reference Computed Torque Control (CRCTC) (Lammerts, 1993) will be considered and compared, in the frequency domain as well as in the time domain. This comparison has been made in computer simulations as well as in experiments.

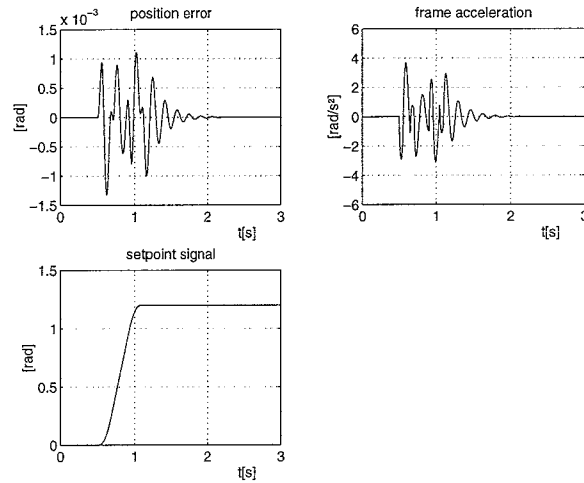

Figure 2: influence of frame vibrations on tracking error

While the same principles hold for rotations as for translations, it causes no problems to use an experimental setup with a rotating system. The setups parameter values were:

- $m_{load} = 0.0089 \text{ kgm}^2$
- $m_{frame} = 0.015 \text{ kgm}^2$
- $f_{frame} = 8.5 \text{ Hz}$  (excl. mass of load)
- $\beta_{frame} = 0.075$

## 2 Control laws

### 2.1 PID-controllers

Both PID-controllers use feedback of the measurements of the load position  $y$  as well as feedforward of the desired load acceleration. Next to this the second PID-controller also uses feedforward of the

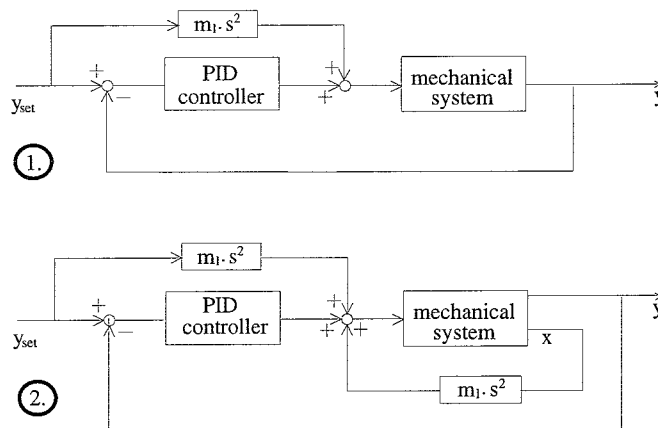

Figure 3: 1.) Ordinary PID-controller, 2.) including feedforward frame accelerations

measured frame accelerations, a concept often used to suppress the influence of frame vibrations on the load position. In the following the ordinary PID-controller will be referred to as cont.1), the PID-controller including frame acceleration feedforward as cont.2) and the CRCTC-scheme as cont.3).

## 2.2 CRCTC

Computed Reference Computed Torque Control is a strategy for the control of flexible manipulators, developed by Lammerts (1993). The CRCTC scheme is based on a model that takes flexibilities into account. Because the desired trajectories of the generalized coordinates cannot all be determined uniquely from the desired end-effector trajectory, a reference trajectory is determined on-line for those generalized coordinates that no desired trajectory is known for beforehand. Such inputs are computed that asymptotic tracking of the end-effector trajectory is realized while deformations remain bounded.

This text covers the background that is required for the application in this particular case. For general theory and stability proofs we refer to Lammerts et al. (1995).

### 2.2.1 Application of CRCTC

The system can be modelled in the following way:

$$M \ddot{\underline{q}} + K \underline{q} + \underline{f} = H \underline{u} \quad (1)$$

where:

$$M = \begin{bmatrix} m_{fr} + m_l & m_l \\ m_l & m_l \end{bmatrix}, K = \begin{bmatrix} k_{fr} & 0 \\ 0 & 0 \end{bmatrix}, H = \begin{bmatrix} 0 \\ 1 \end{bmatrix}, \underline{q} = \begin{bmatrix} x \\ y \end{bmatrix}, \underline{f} = \begin{bmatrix} b_{fr} \dot{x} \\ 0 \end{bmatrix}, \underline{u} = [ F ]$$

The control objective is to determine an input  $u(t)$  such that  $y$  tracks its desired trajectory asymptotically under the condition that  $x$  and  $\dot{x}$  remain bounded. According to the CRCTC-scheme this objective can be reached when:

$$M \ddot{\underline{q}}_r + K \underline{q}_r + \underline{f} + K_r \dot{\underline{e}}_r + K_I \underline{e}_r = H \underline{u} \quad (2)$$

where:

$$K_r = \begin{bmatrix} K_1 & 0 \\ 0 & K_2 \end{bmatrix}, K_I = \begin{bmatrix} K_3 & 0 \\ 0 & K_4 \end{bmatrix}, \underline{q}_r = \begin{bmatrix} x_r \\ y_r \end{bmatrix}, \underline{e}_r = \underline{q}_r - \underline{q} = \begin{bmatrix} e_{rx} \\ e_{ry} \end{bmatrix}$$

Here  $\underline{q}_r$  are the reference trajectories that are calculated on-line, while  $K_r \dot{\underline{e}}_r$  is a PD-like control term and  $K_I \underline{e}_r$  is a PI-like control term.

In case of a perfect model, from (1) and (2) the following error equation results:

$$M \ddot{\underline{e}}_r + K_r \dot{\underline{e}}_r + K \underline{e}_r + K_I \underline{e}_r = \underline{0} \quad (3)$$

The function  $V$  defined by

$$V = \frac{1}{2} \dot{\underline{e}}_r^T M \dot{\underline{e}}_r + \frac{1}{2} \underline{e}_r^T K \underline{e}_r + \frac{1}{2} \underline{e}_r^T K_I \underline{e}_r \quad (4)$$

is a candidate-Lyapunov function if  $K + K_I$  is a positive definite matrix. The time derivative of  $V$ ,

$$\dot{V} = -\dot{\underline{e}}_r^T K_r \dot{\underline{e}}_r \quad (5)$$

is negative for all  $\dot{\underline{e}}_r \neq \underline{0}$  when the gain matrix  $K_r$  is positive definite. So under these conditions for  $K_I$  and  $K_r$  the equilibrium point  $\underline{e}_r = \underline{0}$  is asymptotically stable in the sense of Lyapunov.

The set of equations (2) can be split into two sets of equations. Because the matrix  $H$  has full rank, there exists a regular transformation matrix

$$T = [N \ H(H^T H)^{-1}]^T; \quad N^T H = 0 \quad (6)$$

Premultiplicating (2) with (6) yields

$$N^T [M \ddot{\underline{q}}_r + K \underline{q}_r + \underline{f} + K_r \dot{e}_r + K_I e_r] = 0 \quad (7)$$

$$(H^T H)^{-1} H^T [M \ddot{\underline{q}}_r + K \underline{q}_r + \underline{f} + K_r \dot{e}_r + K_I e_r] = u \quad (8)$$

Substituting  $N^T = [1 \ 0]$  and (1) into (7) and (8) results in the following equations

$$(m_{f_r} + m_i) \ddot{x}_r + m_i \ddot{y}_r + k_{f_r} x_r + b_{f_r} \dot{x}_r + K_1 \dot{e}_{r_x} + K_3 e_{r_x} = 0 \quad (9)$$

$$u = m_i \ddot{x}_r + m_i \ddot{y}_r + K_2 \dot{e}_{r_y} + K_4 e_{r_y} \quad (10)$$

The desired output trajectory is given by the function  $y_d = y_d(t)$ . Let  $e_y = y_d - y$  be the tracking error for  $y$ . Then CRCTC uses a reference trajectory  $y_r$  defined by

$$\dot{y}_r = \dot{y}_d + \lambda e_y, \quad \lambda > 0 \quad (11)$$

Now from (9) a bounded reference trajectory  $x_r$  can be solved on-line, while from (10) the control input  $u$ , which according to Lammerts (1993) guarantees asymptotic tracking of the end-effector and bounded deformations, can be computed. A schematic representation of the CRCTC-scheme is given in Figure4.

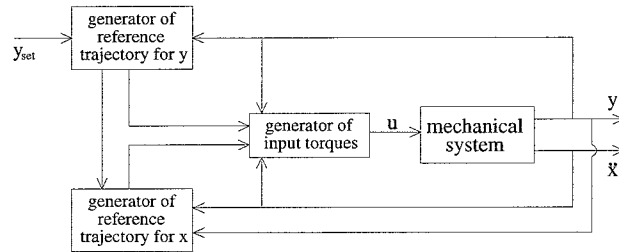

Figure 4: CRCTC-scheme

Because the model used does not take friction into account, while in an experimental situation (coulomb) friction will always occur, the PI-like control term  $K_I e_r$  has been added to the control scheme. Its only task is to suppress the small position errors, that remain when the setpoint reaches a stationary value after a movement, and that are caused by coulomb friction. The value of  $K_3$  will be chosen zero, because we are only interested in asymptotic tracking of the position  $y$ . If  $K_4 > 0$  this will not effect the demand that the matrix  $K + K_I$  has to be positive definite. The PI-like control term has a negative influence on the dynamical behaviour of the controlled system (more overshoot). That's why the value of  $K_4 e_{r_y}$  is limited to a small value. In this way the negative influence on the dynamical behaviour is very small, while the set-point will still be asymptotically tracked with zero position error.

### 2.2.2 State reconstruction

The CRCTC-scheme requires the state of the system to be known, while measurements are available only of  $\ddot{x}$  and  $y$ . Because of quantization errors differentiating of  $y$  leads to unacceptable errors, that's why the velocity  $\dot{y}$  is calculated by weakly differentiating  $y$ , i.e.

$$\dot{y}(s) = \frac{K s}{s + K} y(s), \quad K \text{ large} \quad (12)$$

In the actual implementation for  $K$  a value of 600 is used, so only frequencies lower than about 100 Hz are differentiated. This value is chosen with respect to the sampling frequency during the experiments of 800 Hz and the bandwidth of the various controllers that is far lower than 100 Hz. A Kalman reconstructor is used to obtain the state variables  $x$  and  $\dot{x}$ . Integrating the acceleration  $\ddot{x}$  is not possible because the measurement noise would cause drifting away of the integrated signals. A Kalman reconstructor is a linear minimum variance estimator that predicts the state, using a linear model and the input of the system.

### 3 Theoretical approach

#### 3.1 Frequency Domain

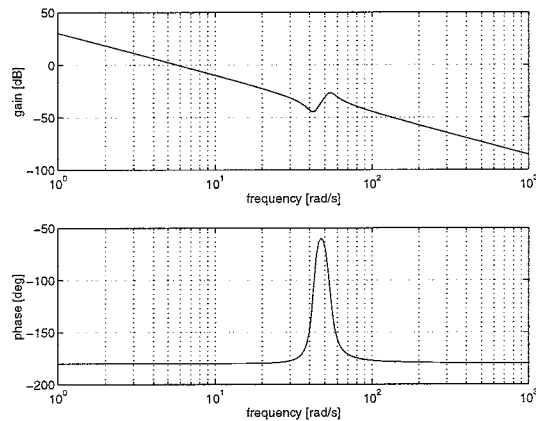

Figure 5: Bode diagram of the mechanical transfer function

Figure 5 shows the bode diagram of the mechanical transfer function ( $y/u$ ) of the system. Near the frame resonance frequency of 53.4 [rad/s] a zero/pole or a antiresonance/resonance peak, that leads to a phase lead, can clearly be seen.

##### 3.1.1 Open loop transfer functions

In order to be able to look at the stability of the different control schemes the theoretical open loop transfer functions have been compared. For this purpose the control loops were opened just before the mechanical system and via MATLAB (Matlab, 1993) the transfer functions were determined directly from the SIMULINK (Simulink, 1993) models of the systems.

All controllers were tuned for optimal setting time, i.e. the time to reach the final setpoint value, during the experiments, which resulted in the following parameters for the PID-controllers:  $P = 80$ ,  $I = 40$ ,  $D = 1.8$  and for the CRCTC-law:  $K_1 = 0.5$ ,  $K_2 = 0.5$ ,  $K_4 = 10$ ,  $\lambda = 20$ . More about controller tuning will follow in section 4.3.

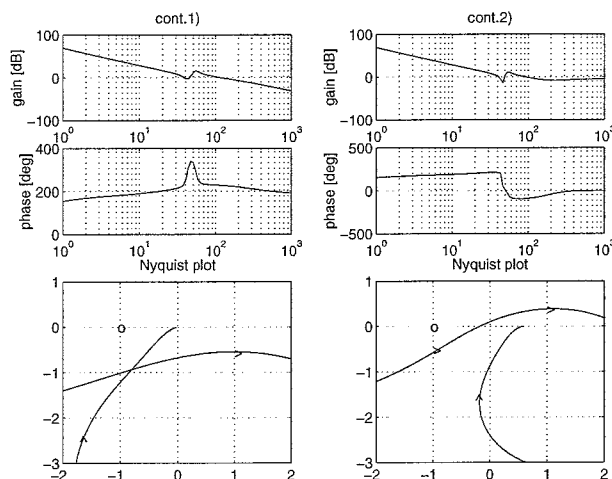

Figure 6: Open loop transfer functions of both PID-controllers

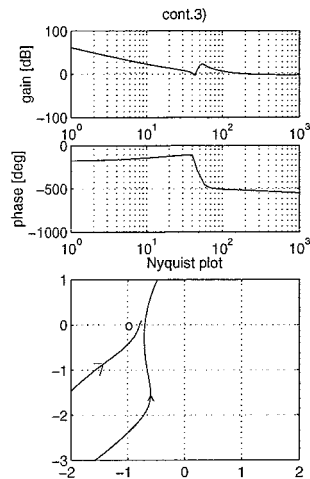

Figure 7: Open loop transfer function of the CRCTC-scheme

Figure 6 and Figure 7 show the Bode plots as well as the Nyquist plots of the open loop transfer functions of the three different controller configurations. As can be seen from the Nyquist plots, cont.1) has a phase margin of  $48^\circ$ . Frame acceleration feedforward reduces this phase margin to  $29^\circ$  (at a frequency of about 40 rad/s), as can be seen in the Nyquist plot of cont.2). The gain margin (i.e. the distance to the point -1 at a phase of  $-180^\circ$ ) reduces from 1 to 0,82. So frame acceleration feedforward reduces the stability of the controlled system.

The phase margin of the CRCTC-scheme is  $20^\circ$ , reached at a frequency of 234 rad/s, while the gain margin is 0,21, reached at a frequency of 671 rad/s. These values are caused by the left part of the graph in the Nyquist plot. When we look at the stability margins in the same frequency area as for cont.1) and cont.2) (right part of the graph), we obtain the following values: phase margin  $46^\circ$  (at 43 rad/s), gain margin 0,3 (at 41 rad/s).

### 3.2 Time simulations

In SIMULINK also time simulations of the dynamical behaviour of the various controlled systems were performed. Therefore the response to a third-order set-point was calculated. In this ideal

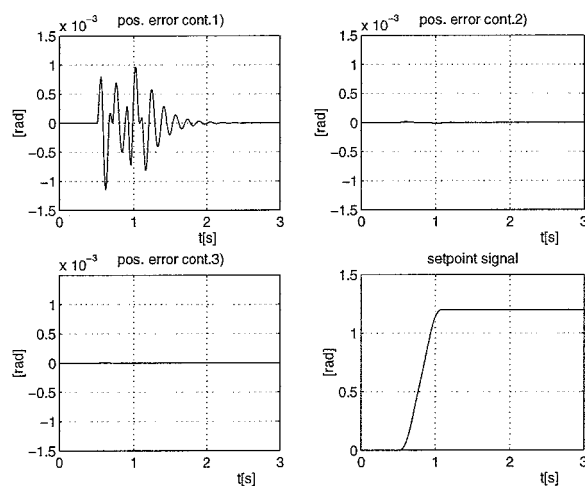

Figure 8: position errors, set-point during computer simulations



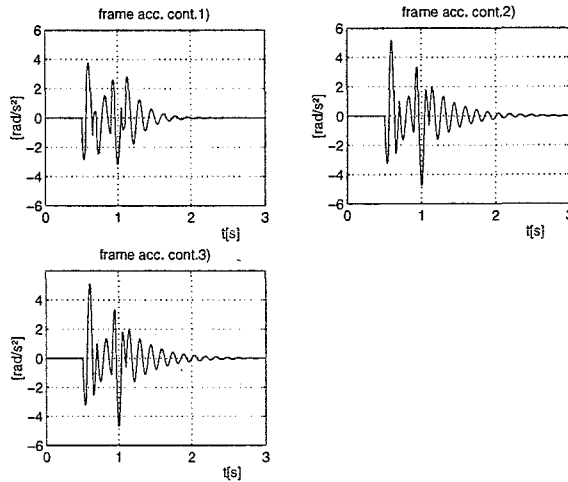

Figure 9: frame accelerations during computer simulations

situation (perfect model, no friction) both cont.2) and cont.3) totally suppress the influence of the frame vibrations and succeed in tracking the set-point with zero error, while the ordinary PID-controller clearly shows the effect of the frame vibrations on the position error. Figure 9 shows that higher damping of the frame vibrations is realized by the ordinary PID-controller. So reduction of the influence of the frame vibrations in the tracking error results in more vibrations of the frame itself.

## 4 Experiments

### 4.1 Experimental setup

Experiments have been carried out on a rotating system as in Figure 10. The end-effector is a

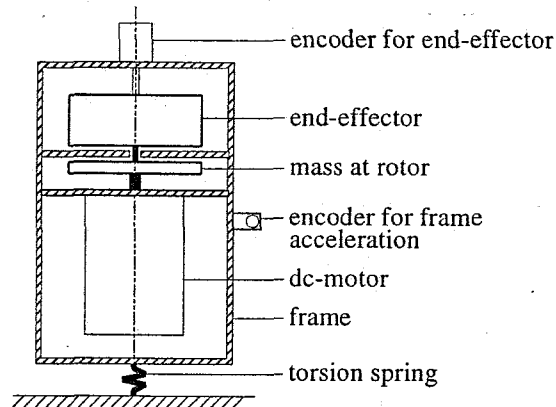

Figure 10: The experimental set-up of the flexible R-manipulator

cylindrical body (rotation inertia  $m_e$ ), which can rotate around the vertical axis. It is connected to the actuator rotor (rotation inertia  $m_r$ ) by an axe which for now is considered stiff. So for the total inertia of the load holds  $m_l = m_e + m_r$ . The machine frame is connected to the solid world by a torsional spring (linear, elastic, stiffness  $k_{fr}$ ) and a damper (linear, viscous, damping coefficient  $b_{fr}$ ). Parameter values can be found in section 1).

The actuator is a DC-motor, which generates the torque  $F = c u$  between the rotor and the stator. Here,  $u$  is the input of the manipulator and  $c$  is a constant with a value of  $0.295 \text{ [Nm/V]}$ .

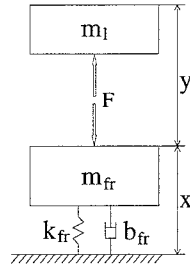

Figure 11: Model of the flexible R-manipulator

Interfacing between the R-manipulator and a PC was performed by dSPACE (DSP-CITpro, 1993). This enables a very flexible coupling between MATLAB and SIMULINK and the actual R-manipulator. Control laws written in SIMULINK are automatically translated to C-language and downloaded to the setup, while measurements can easily be stored and transferred to MATLAB. It is also possible to adjust the controllers parameters on-line during the experiments. In this way the effect of the various parameters on the performance can easily be seen and controller tuning is very simple.

## 4.2 Frequency domain

The mechanical transfer function ( $y/u$ ) of the system has been measured by applying a white noise signal to the motor. The output  $y$  of the system is measured and by means of the spectrum function of MATLAB the transfer function has been calculated. If we compare Figure 12 with Figure 5 we can see that the gain of theoretical and measured transfer function for the middle frequencies are very much alike, however in the measured transfer function there occurs an extra

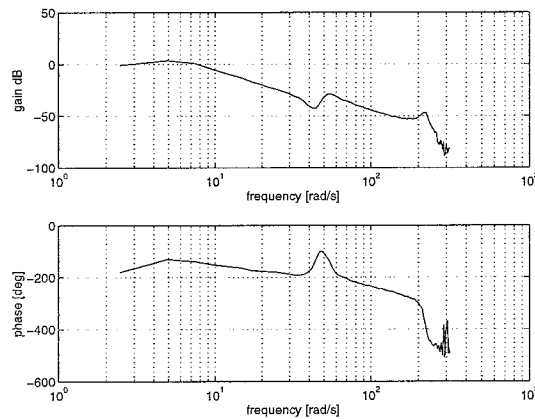

Figure 12: Bode diagram of the mechanical transfer function

resonance at 230 rad/sec. This is caused by the connection between rotor and end-effector, that is not totally stiff as assumed, and this extra resonance will appear to be very important for the controllers performances.

## 4.3 Controller tuning

The controllers are tuned in order to obtain an optimal time response. In order to reach this the controllers parameters will have to be as high as possible, so that a small tracking error immediately leads to a control action. However the values of these parameters are limited by the higher order dynamics of the system. When the controllers parameters are increased too much

the resonance frequency between rotor and end-effector is excited, which leads to severe vibrations that strongly affect the position error.

The parameters of the PID-controllers are chosen such that these vibrations do not occur, while in particular raising the D-action very soon leads to exciting the resonance frequency.

The CRCTC-law is more sensitive for the extra resonance. Here  $K_2$  and in a minor degree  $K_1$  are the most sensitive parameters. This is in accordance with the Nyquist plot (Figure 7) that comes near -1 for higher frequencies. It is also caused by the fact that the CRCTC-scheme is a model-based control law, while the model used does not take the extra resonance frequency into account. That's why an attempt was made to apply CRCTC when using a higher order model, but this leads to instable differential equations for the reference trajectories. Solving this problem was beyond the aim of this investigation.

#### 4.4 Time responses

Experiments have been performed with the same third-order set-point as during the computer simulations. As can be seen in Figure 13 the small values of these errors cause problems with

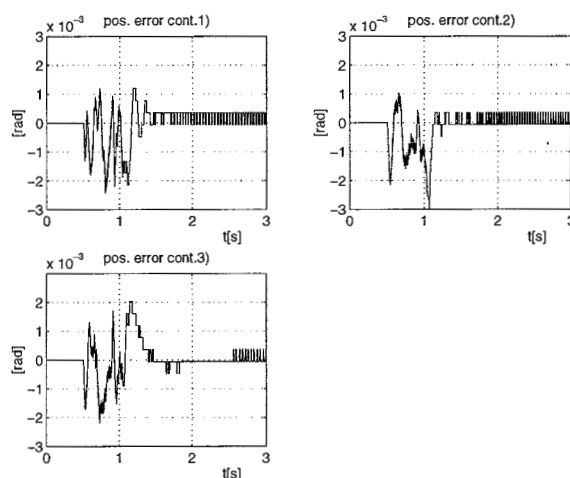

Figure 13: position errors in experiments

respect to the resolution of the encoders. Because the encoder increments are quite large with respect to the errors, no good conclusions can be taken from these plots. That's why in the following plots the mean values of 10 different measurements are considered.

##### 4.4.1 Results

In Figure 14 the mean position errors of 10 different measurements are represented, while also the values of plus and minus one encoder increment ( $0,42e-3$ ) are shown. Within those bounds no conclusions can be made anymore, because clipping between two encoder values occurs as can be seen in Figure 13.

Due to friction and other disturbances, the position errors are larger as in the computer simulations. In the experimental situation cont.2) also shows a clearly better suppression of the effect of the frame vibrations on the position error than cont.1), though there are still some minor vibrations in the position error.

The performance of cont.3) is slightly worse than that of cont.2), while the expectation was that CRCTC, a model-based control strategy, would perform at least as good. The explanation for this is that the model used for CRCTC at first doesn't take into account friction and at second has only two degrees of freedom, which are important differences in comparison with the actual system with friction and three degrees of freedom.

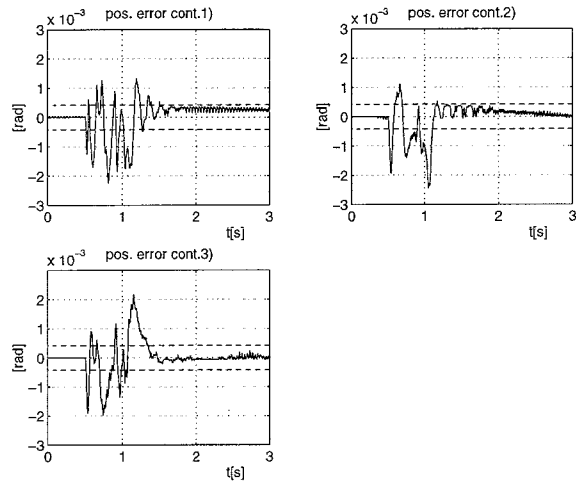

Figure 14: mean position errors in 10 experiments

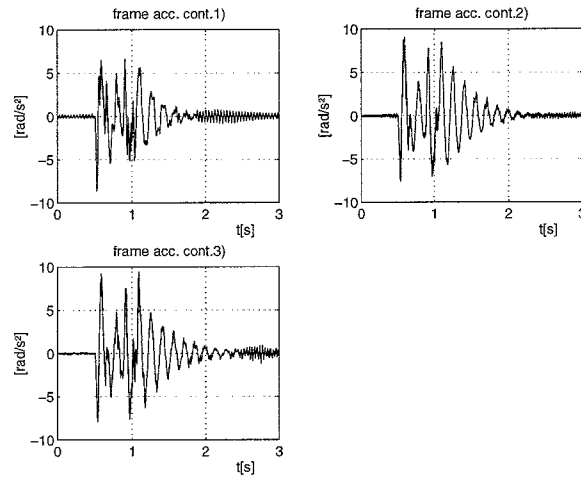

Figure 15: mean frame accelerations in 10 experiments

Looking at the frame accelerations in Figure 15 the same phenomenon as during the computer simulations occurs; suppression of the influence of the frame vibrations on the position error results in more vibrations of the frame itself.

Comparing the computer simulations with the experiments the conclusion can be made that with respect to the frame vibrations the computer simulations gave a rather good indication of the systems behaviour, but because of friction the experimental position errors differ from the simulated ones.

## 5 Conclusions

Controlling a system with a flexible frame with a conventional PID-controller clearly shows the undesired influence of frame vibrations in the tracking error. Adding frame acceleration feedforward to a PID-controller effectively suppresses the oscillations in the tracking error caused by the frame vibrations. However, this leads to more vibrations of the frame itself and the stability margins decrease with respect to a conventional PID-controller.

The CRCTC-law proposed in this article does not succeed in improving the performance of a PID-

controller including frame acceleration feedforward. But only a simple model with two degrees of freedom and without friction was used, and the model parameters were estimated off-line by means of simple experiments. The performance of the CRCTC-law could very probably be improved by properly modelling the friction. Applying an adaptive version of CRCTC, with on-line adaptation of the model parameters, would probably give even better results.

Another important cause of worse performance as expected is the fact that the CRCTC-law, based on a model with two degrees of freedom, is used for an experimental system that clearly has three degrees of freedom. Using a CRCTC-law based on a three degree of freedom model would probably give better results, though more research will have to be spend in order to solve the instable differential equations for the reference trajectories in that case. Applying the developed CRCTC-law to an experimental system that actually has only two degrees of freedom would be interesting and because of the better resemblance between model and experimental set-up this would probably give a better CRCTC-performance also.

## References

- DSP-CITpro*, 1993, dSPACE digital signal processing and control engineering GmbH, Paderborn, Germany
- Lammerts, I.M.M., 1993, *Adaptive Computed Reference Computed Torque Control of Flexible Manipulators*, Ph.D. Thesis, ISBN 90-386-0332-0, Eindhoven University of Technology, The Netherlands
- Lammerts, I.M.M., Veldpaus, F.E., Van de Molengraft, M.J.G., Kok, J.J., 1995, "Adaptive Computed Reference Computed Torque Control of Flexible Robots", *ASME Journal of Dynamic Systems, Measurement and Control*, Vol. 117, pp. 31-36
- Matlab; High performance numeric computation and visualisation software*, 1993, The Math Works Inc., Natick, Massachusetts, USA
- Rankers, A.M., van Eijk, J., 1994, "The influence of reaction forces on the behaviour of high performance motion systems", *Second International Conference on Motion and Vibration Control*, Yokohama, Japan, Aug.30 - Sept.3
- Simulink; A program for simulating dynamic systems*, 1993, The Math Works Inc., Natick, Massachusetts, USA