

Current chopping in SF6

Citation for published version (APA):

van den Heuvel, W. M. C. (1980). *Current chopping in SF6*. (EUT report. E, Fac. of Electrical Engineering; Vol. 80-E-107). Technische Hogeschool Eindhoven.

Document status and date:

Published: 01/01/1980

Document Version:

Publisher's PDF, also known as Version of Record (includes final page, issue and volume numbers)

Please check the document version of this publication:

- A submitted manuscript is the version of the article upon submission and before peer-review. There can be important differences between the submitted version and the official published version of record. People interested in the research are advised to contact the author for the final version of the publication, or visit the DOI to the publisher's website.
- The final author version and the galley proof are versions of the publication after peer review.
- The final published version features the final layout of the paper including the volume, issue and page numbers.

[Link to publication](#)

General rights

Copyright and moral rights for the publications made accessible in the public portal are retained by the authors and/or other copyright owners and it is a condition of accessing publications that users recognise and abide by the legal requirements associated with these rights.

- Users may download and print one copy of any publication from the public portal for the purpose of private study or research.
- You may not further distribute the material or use it for any profit-making activity or commercial gain
- You may freely distribute the URL identifying the publication in the public portal.

If the publication is distributed under the terms of Article 25fa of the Dutch Copyright Act, indicated by the "Taverne" license above, please follow below link for the End User Agreement:

www.tue.nl/taverne

Take down policy

If you believe that this document breaches copyright please contact us at:

openaccess@tue.nl

providing details and we will investigate your claim.

th e

CURRENT CHOPPING IN SF₆

by

W. M. C. van den Heuvel

E I N D H O V E N U N I V E R S I T Y O F T E C H N O L O G Y

Department of Electrical Engineering
Eindhoven The Netherlands

CURRENT CHOPPING IN SF₆

by

W.M.C. van den Heuvel

TH-Report 80-E-107

ISBN 90-6144-107-2

Eindhoven

April 1980

Contents:

	Page
Summary	1
List of symbols	3
1. Introduction	4
2. Origins for current chopping	4
2.1. Forced current zero and current chopping due to negative arc characteristic	4
2.2. Current chopping by arc collapse	9
2.3. Current chopping by main circuit oscillations	10
2.4. Current chopping by arc-to-glow-discharge transition	11
2.5. Current chopping by electrode effects	12
3. Current chopping in SF ₆	13
3.1. Experimental set-up and procedure	13
3.2. Equivalent test scheme	15
3.3. Test results	16
4. Discussion of results	23
5. Conclusions	27
6. Acknowledgement	28
Literature	29

Summary.

After a short treatise on the origins of current chopping an experimental study of small current interruption in SF₆ is reported. A puffer type circuit breaker model was used. During contact separation two different types of arcs occurred successively. Short gap lengths up to ≈ 0.5 mm gave stable arcs with low arc voltage and small time constant (≈ 0.15 μ s). Typical chopping level of this "A-mode" was 0.3 A. Further opening of contacts caused a transition into a "B-mode" arc with many elongations and collapses. This arc type had a higher average voltage and a typical chopping level of ≈ 0.5 A. A time constant of ≈ 0.5 μ s could be deduced from stability theory. But this theory could only be proved for the A-mode arc.

It is further shown that only circuit elements in direct vicinity to the breaker were involved in the chopping phenomena. Chopping levels of the B-mode arc were independent of arc length or current to interrupt but could be raised by capacitance in parallel to the breaker.

All reignitions were of dielectric nature and post arc conductivity was never found.

Heuvel, W.M.C. van den

CURRENT CHOPPING IN SF₆.

Eindhoven University of Technology, Department of Electrical Engineering,
Eindhoven, The Netherlands. April 1980.

TH-Report 80-E-107

Address of the author:

Prof.dr.ir. W.M.C. van den Heuvel,
High Current Laboratory,
Eindhoven University of Technology,
P.O. Box 513,
5600 MB EINDHOVEN,
The Netherlands

List of symbols.

C, C_p	effective capacitance in parallel to the arc
C_s	effective source side capacitance
C_t	effective load side capacitance
f	frequency, see table 1
f_i	frequency of arc oscillation
f_o	f_i at inset of instability
i_o	arc chopping current
\hat{i}	crest value of current to interrupt
I_A	arc current, (quasi) stationary value
i_a	arc current, momentary value
i_c	current through capacitor in parallel to the arc
K	constant of arc characteristic
L_a	dynamic arc inductance in equivalent arc scheme
L, L_p	effective circuit inductance between C, C_p and arc
L_s	effective source side inductance
L_t	effective load side inductance
R_a	static arc resistance
R_d	absolute value of dynamic arc resistance
R_i	negative resistance in equivalent arc scheme
S	standard deviation
u_a	arc voltage, momentary value
u_c	voltage across capacitance in parallel to the arc
u_o	arc voltage, mean value before current chopping
α	current exponent of arc characteristic
θ	arc time constant
ω	circular frequency, see table 1
ω_i	$2\pi f_i$
ω_o	$2\pi f_o$

1. Introduction.

If a small current is interrupted by a circuit breaker in an a.c. network the arc always ceases before the current has reached its natural zero value. The sudden current chopping can give rise to high overvoltages across inductivities in the interrupted circuits. These overvoltages may be dangerous especially when no-load transformers or reactors with small parallel capacitance are switched off.

Many investigators put attention to current chopping phenomena in air-blast, oil and vacuum breakers [1-13] but few information is available on current chopping in SF₆ [13, 27] .

This paper gives a short survey of the origins for current chopping in high voltage networks and describes an investigation of current chopping in SF₆. The experiments are performed with a puffer-type breaker model in a medium voltage (10 kV) lab circuit.

The results are used to deduce arc time constants from the Mayr-Rizk instability theory.

2. Origins for current chopping.

Current chopping can be produced by a variety of causes:

- arc instability due to the negative slope of the U(I)-characteristic;
- arc elongation followed by breakdown over a smaller distance;
- main circuit oscillations, including virtual current chopping;
- arc to glow discharge transition;
- electrode effects

and by combinations of these effects.

These origins of current chopping will first be treated shortly.

2.1. Forced current zero and

current chopping due to negative arc characteristic

Even for a constant arc voltage there will be a slightly forced current zero if the arc voltage cannot be neglected in comparison with the main

voltage. This phenomenon is well known from synthetic testing practice [26]. It is much more dominating during small current interruption because of the steeply rising voltage with falling current and the small rate of change of current. The effect is increased by the capacitance in parallel to the breaker.

This kind of "current chopping" is essential for low voltage interruption and medium voltage magnetic blast circuit breakers. It forces a monotonically decreasing current. Familiar to it is the forced current zero in interrupting short circuit currents, where the electrical conductivity disappears before the voltage suppression peak has reached its maximum (fig. 1). This effect was first described by Van Sickle [14] and later expanded by Puppikofer [15]. The latter applied it to explain current chopping when interrupting no-load transformers. More recently Young [7] and Rieder [16] used this model.

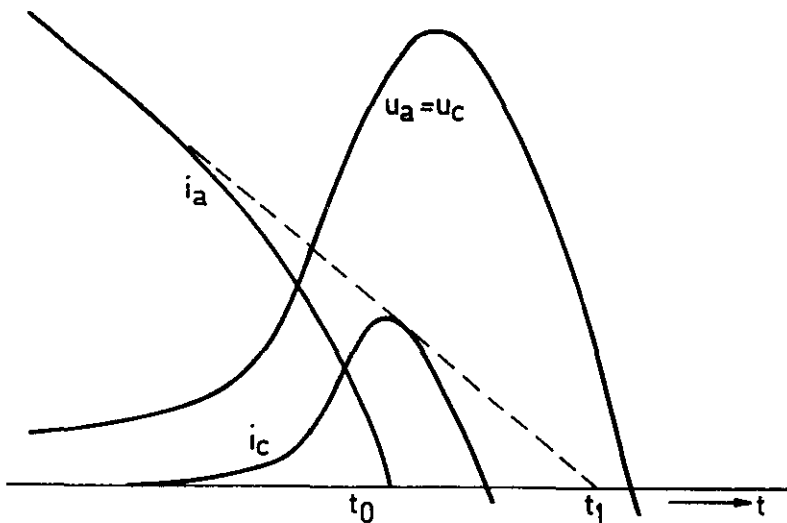

Fig. 1. Forced current zero (t_0) due to parallel capacitance.

The van Sickle-Puppikofer effect is not very likely in small current circuits containing oil, air blast, SF_6 or vacuum breakers. It needs a high capacitance C_p in parallel to the breaker combined with a small inherent inductance. This can be illustrated by a simple example. If the arc characteristic be presented by $ui=K$ and current fall by $di/dt=\omega\hat{I}$,

about 10% of the main current $i(t)$ is commutated in the capacitor if $i = (10K\omega C_p \hat{I})^{1/3}$. So if e.g. $K=1000$, $\omega=314$ and $\hat{I} \approx 30$ A a capacitor as large as $1 \mu\text{F}$ starts to be effective if the current $i(t) < 3$ A. In practice the effective capacitance at low current interruption is generally much smaller and current chopping levels with such parallel capacitors are much higher than 3 A [10,11].

So it is not surprising that a monotonically falling current never was observed in our test circuits.

In vacuum breakers the arc loses its conductivity suddenly within much less than a microsecond. This kind of chopping was also observed in SF_6 at very small arc lengths. In all other cases current chopping was accompanied by some form of high frequency disturbance. Best known is the "instability oscillation" with increasing amplitude superimposed on the main frequency current, fig. 2.

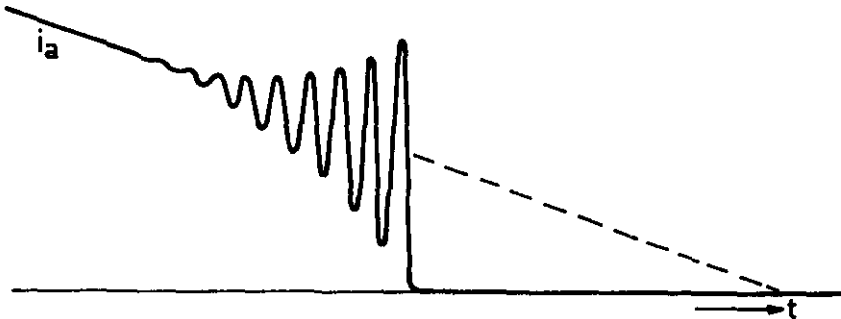

Fig. 2. Forced current zero due to instability oscillation.

In principal a high frequency oscillation can be concluded from the (quasi) static arc characteristic [1]. But as the period of the instability oscillation is of the same order of magnitude as the thermal arc time constant it is clear that the dynamic behaviour of the arc is involved in the phenomena.

Dynamic arc instability was amply studied by Mayr [17] as early as 1943. Afterwards several authors [2-4] employed his results to specific circuits. They all accept an exponential adaption of electrical conductivity with an "arc time constant" after a small current step (fig. 3). This leads to an equivalent transient impedance scheme for the arc, including an inductance and a negative resistor, giving the same response to a current step.

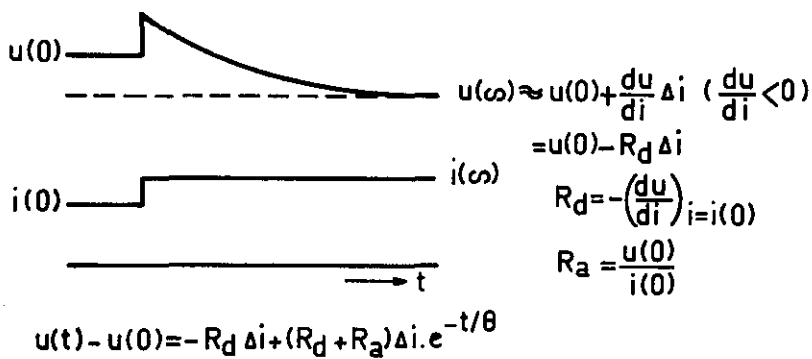

Fig. 3. Exponential arc voltage response.

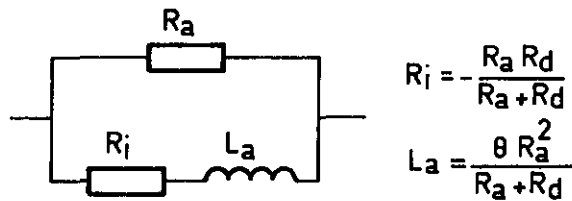

Fig. 4. Dynamic arc scheme from exponential response.

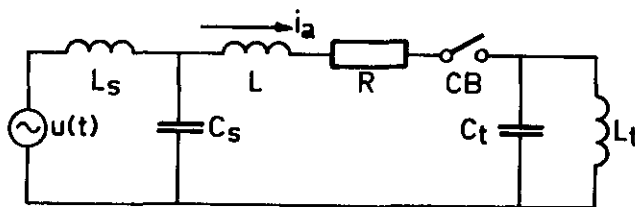

Fig. 5. Equivalent circuit used for stability investigation.

The most extensive study, directed to high voltage network circuits, was published by Rizk [4]. He derived the equivalent arc scheme of fig. 4 and used this scheme at the place of the circuit breaker in a one phase circuit proposed by Baltensperger (fig. 5). Accepting that L_s and L_t are so large that they are not involved in the high frequency phenomena leaves a third degree differential equation for the remaining circuit. Using Hurwitz criteria and putting in $R \ll R_d$ he found the requirement for stable solutions: *)

$$\frac{R_a}{C} - \frac{R_a R_d}{\theta} - \frac{L_a R_d}{\theta^2} > 0 \quad (1)$$

At the stability limit an oscillation rises with frequency

$$\omega_i = \omega_o = 1/\sqrt{C(L+\theta R_a)} \quad (2)$$

(Note that the arc acts as a *virtual inductance* with magnitude θR_a).

Combining (1) and (2) yields

$$\omega_o = \frac{1}{\theta} \sqrt{\frac{R_d}{R_a}} \quad (3)$$

If the quasi-static arc characteristic at the inset of instability is represented by

$$U_a I_a^\alpha = K = \text{constant} \quad (4)$$

one finds (with $R_d = -\alpha R_a$) Rizk's stability criterium

$$\frac{1}{C} - \frac{\alpha R_a}{\theta} - \frac{\alpha L}{\theta^2} = 0 \quad (5)$$

*) See fig. 3,4,5 and list of symbols for meaning of letters.

Combining this result with (2) shows that the frequency at inset of instability is

$$\omega_o = \sqrt{\alpha/\theta} \quad (6)$$

(Rizk further studied the influence of a capacitor or a resistor directly across the breaker, the influence of the source side and load side inductivities and of the fact that in practice L's and C's are distributed instead of lumped elements. He also put attention to multi-time-constant arcs and to the wellknown fact that the arc time constant is not a constant).

Mayr as well as Rizk emphasized that stability testing at best can yield the condition at which an instability oscillation will be superimposed on the arc current. But it cannot at all produce a pronouncement whether the current will really chop.

Our experiments learned that the criteria satisfy very well for short arcs and very small chopping levels when $\theta \gg L/Ra$. The arcs then burn so stable that α can be determined with good accuracy. Moreover a growing instability current soon leads to a current chopping because of the low main frequency current value.

2.2. Current chopping by arc collapse.

The intensive cooling by a moving gas can cause strong elongations and even curls in small current arcs especially at longer contact gaps [4,5]. At the same time the arc voltage rises rapidly to a high value and introduces a breakdown across a smaller distance by short circuiting part of the arc. These phenomena will be called here "arc collapse". It can repeat many times before the current chops and so causes the well known irregular pattern in the voltage trace on many oscillograms of small current interruption (see e.g. fig. 15).

Arc elongation can introduce current chopping after an increasing instability oscillation because in equation (5) α may be high and R_a increases rapidly.

During arc elongation the inherent circuit breaker parallel capacitance is charged to a high voltage and after arc collapse the voltage surplus may cause an oscillating current through the arc. This oscillation is superimposed on the quasi steady state arc current and may cause current chopping by forcing the latter to zero in the first negative half loop. The arc collapse oscillation is damped by the arc resistance. Its frequency is principally determined by the virtual arc inductance θR_a and the parallel capacitance C_p , the same elements which are involved in the instability oscillation. Therefore the frequency is of the same order of magnitude in both cases.

At first glance one might expect that arc collapse would cause a higher chopping level than dynamic arc instability. The experimental fact that up to now no notable difference could be concluded is theoretically explained in a separate paper ^{x)}.

Murano e.a. [10] reported that their choppings were always preceded by an arc collapse when testing air-blast and oil breakers with additional parallel capacitors. The same tendency was found in our experiments in SF₆.

2.3. Current chopping by main circuit oscillations.

Sudden variations of the arc resistance, especially arc collapse and reignitions after a short period of interruption, can produce oscillations in the surrounding circuitry and even in the complete main circuit [5,18]. These oscillations are again superimposed on the industrial frequency current. They can force the current to zero directly or to such a low momentary value that "normal" current chopping starts.

^{x)} soon to be published elsewhere.

The special case where arc reignition in one phase of a three phase circuit induces current zero's in the other two phases is called "virtual current chopping". It can cause extremely high overvoltages in the system when the circuit breaker has no post arc current and builds up a high dielectric strength in a short time. This is especially the case in vacuum and SF₆. A treatise on virtual current chopping can be found in literature [18-20].

2.4. Current chopping by arc-to-glow-discharge transition.

Hydrogen is the principal decomposition product (80%) of oil by the burning arc. Edels [21] reported arc-to-glow transition in hydrogen of 0.5 to 2 bar at a critical current value of ≈ 1.5 A. The transfer was always accompanied by a large jump to lower current density and a (relatively lower) jump in voltage. Normally the circuit elements do not allow a sudden discharge-voltage jump during small current interruption and one may expect that the current chops at the transfer level. In our experiments with oil breakers the lowest chopping level which could be attained, even when interrupting purely resistive currents, was 1.3 A. The same limit was reported by Damstra [8]. It is very likely that the pressure in the gas bubble in oil during small current interruption is very near to normal.

According to Edels [22] arc-to-glow discharge transfer in N₂ at 1 bar takes place at 0.5 A. Because of the highly unstable nature of the arc at higher current levels one may not expect that this transfer has any significance in air blast breakers.

In experiments with the SF₆-model short arcs could be stable down to ≈ 0.3 A and then sometimes abruptly stopped without any oscillation (see fig. 14). Up to now it could not yet be concluded whether this kind of chopping is due to arc column or to electrode effects.

2.5. Current chopping by electrode effects.

All specified reasons mentioned before were in some way connected to the properties of the arc column especially to the negative slope of the (quasi) stationary arc characteristic. The vacuum breaker arc has a positive u-i-characteristic and for small currents an extremely low column voltage. This metal vapour arc has an essentially unstable character. It has a continuous decay and renewal of cathode processes. Each cathode has a limited lifetime (of the order of 10^{-7} - 10^{-6} s) and current (≈ 100 A for Cu contacts). Daalder [23] showed theoretically and experimentally that Joule heating in and ion production at the cathode surface are evident for maintenance of the arc processes. Up to now a quantitative determination of the minimum current in a cathode spot is not yet deduced from theory. Experiments show chopping levels of ≈ 4 and ≈ 9 A for Cu and W respectively. Lower values are obtained in commercial available breakers by using special alloys as contact material. An extensive study of current chopping by vacuum arcs is reported by Holmes [24].

Because of the short lifetime of individual cathode spots and the positive slope of the arc characteristic vacuum arc chopping shows an extremely steep current decay without any instability oscillation. In other circuit breakers the same picture of chopping was only found in SF₆, as mentioned before.

Farrall and Cobine [25] investigated low current arcs in Ar, N₂, He, H₂, O₂ and SF₆ in a low voltage circuit (125 V d.c.). They showed that under these conditions arc duration is statistical. Typical lifetimes for SF₆ were of the order of 0.1s. In their opinion the duration of arcs in gases is principally determined by the abundance of metal vapour near the cathode and its loss rate through the surrounding gas. So current chopping due to electrode effects is principally possible in all kinds of breakers but has no practical importance except for vacuum.

3. Current chopping in SF₆.

3.1. Experimental set-up and procedure.

To facilitate comparison with other types of breakers investigated formerly [5,6] a same experimental set-up was chosen as much as possible. The circuit of fig. 6 was used. Low voltage main network feeds in via a threephase transformer 380 V/10 kV from which two phases are used. Inductive load are low voltage air-core coils connected via a second 10 kV/380 V transformer. Programmed switching at the low voltage source side prevented in-rush effects.

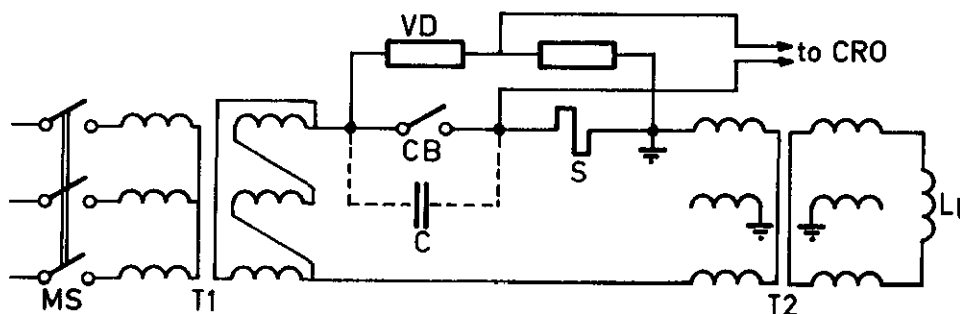

Fig. 6. Test circuit

- MS : Make switch
- T1 Transformer 0,38/10 kV, 400 kVA
- T2 Transformer 0,38/10 kV, 315 kVA
- CB Breaker under investigation
- VD voltage divider
- S shunt
- C capacitor in parallel
- L₁ inductive load

For current measurements low inductance shunts with a straight response characteristic from d.c. to > 10 MHz/s were employed. Voltages were measured via a mixed (capacitive-resistive) divider with a low capacitance (25 pF) and high resistor value (400 MΩ). Circuitry and measuring techniques are amply described in [5].

The experiments were carried out with a medium voltage SF₆ puffer-type breaker model (fig. 7). The static pressure was kept at 3 bar (abs). The total dynamic pressure during operation without current flow never exceeded 3.5 bar (abs). Dynamic pressure could not yet be determined during current interruption because of the severe signal disturbances caused by the burning arc. One may expect that even for the highest currents investigated (42 A) no notable pressure increase exists.

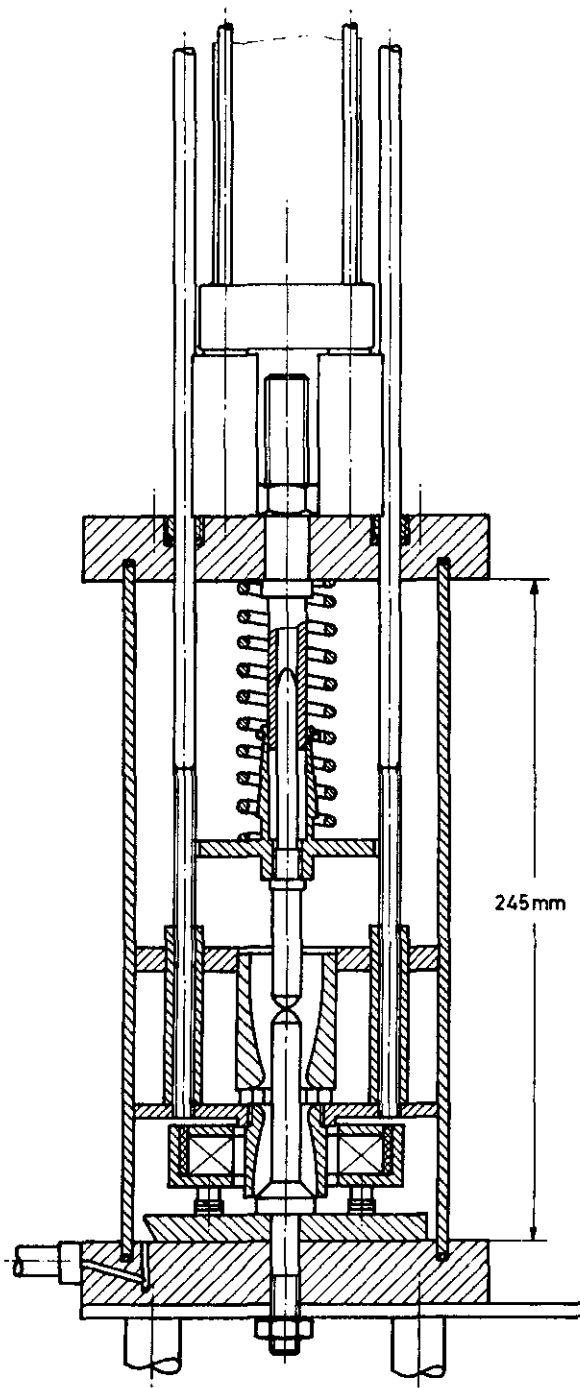

Fig. 7. SF₆ breaker model.

Currents of 8, 16, 30 and 42 A (crest values) were investigated without additional parallel capacitance, 8 and 42 A with 6,000 pF and 8 A with 12,400 pF added in parallel to the breaker. The circuit voltage was kept 10 kV (r.m.s.)

The average contact opening speed was 0.4 m/s with a dip to ≈ 0.2 m/s at the very moment of contact separation for the experiments described here. This feature made it possible to study short and relatively stable arcs during the first current zero as well as longer arcs liable to violent disturbances during the second, final zero. This advantage had to be paid by a larger inaccuracy in estimating short gap lengths.

3.2. Equivalent test scheme.

Detailed study of all oscillations during a complete interruption cycle combined with high frequency impedance measurements made it possible to deduce the practical equivalent scheme of fig. 8. All dampings are neglected. The high frequency resistance R measured across the open circuit breaker was $1 - 2 \Omega$ between 0.5 and 2 MHz. In table 1 all oscillations are summarized. Numbers refer to indications in fig. 8.

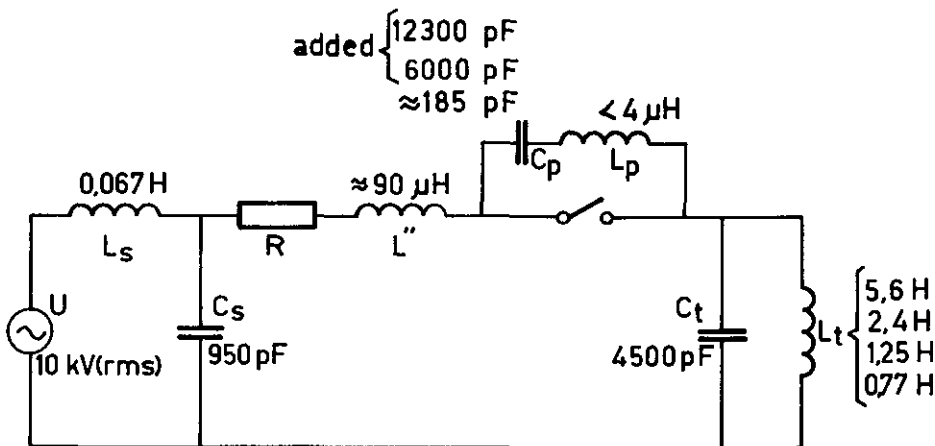

Fig. 8. Equivalent circuit derived from test results.

Name	Symbol	Measured values
Industrial frequency	ω_n	$f_n = 50 \text{ Hz}$
Instability oscillation	ω_i	$f_i = 0.1 - 2 \text{ MHz}$
Oscillations after a reignition:		
First parallel osc.	$\omega_{P1} = (L_P C_P)^{-1/2}$	$f_{P1} > 5 \text{ MHz}, C_P \approx 185 \text{ pF}$ $1.05 \text{ MHz}, C_P \approx 6200 \text{ pF}$ $0.7 \text{ MHz}, C_P \approx 12500 \text{ pF}$
Second parallel osc.	$\omega_{P2} = (L'' C'')^{-1/2}$	$f_{P2} \approx 0,6 \text{ MHz}$
Main circuit osc.	$\omega_{st} = (L' C')^{-1/2}$	$f_{st} = 8,5 \text{ KHz}, L_t = 5,6 \text{ H}$
Oscillations after current interruption		
Source side osc.	$\omega_s = (L_s C_s)^{-1/2}$	$f_s = 20 \text{ KHz}$
Load side osc.	$\omega_t = (L_t C_t)^{-1/2}$	$f_t = 1010 \text{ Hz}, L_t = 5,6 \text{ H}$ $1530 \text{ Hz}, L_t = 2,4 \text{ H}$ $2150 \text{ Hz}, L_t = 1,2 \text{ H}$ $2740 \text{ Hz}, L_t = 0,8 \text{ H}$

Table 1. Review of oscillations. Here $C' = C_s + C_t$;

$$C'' = C_s C_t / C' ; L' = L_s L_t / (L_s + L_t).$$

Further symbols refer to fig. 8.

3.3. Test results.

In spite of the relatively low pressure and contact speed and sometimes high restriking voltages (> 4 p.u.) never a full current loop could be produced after contact separation during these tests. The maximum possible arc length showed to be $\approx 5 \text{ mm}$ according to a life-time of $\approx 14 \text{ ms}$.

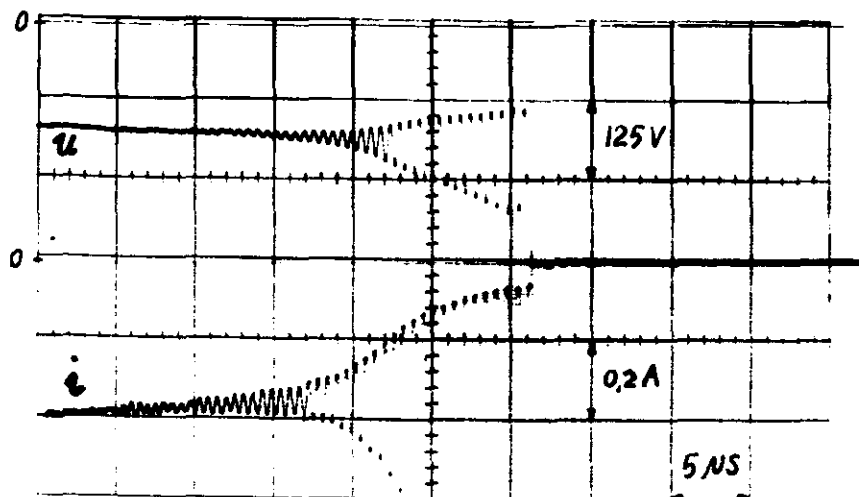

Fig. 9. A-mode chopping, $\hat{I} = 8 \text{ A}$

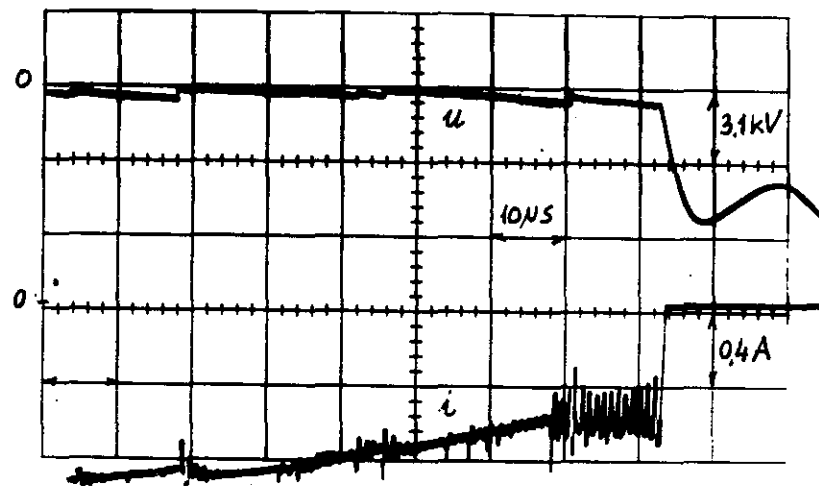

Fig. 11. B-mode chopping, $\hat{I} = 8 \text{ A}$

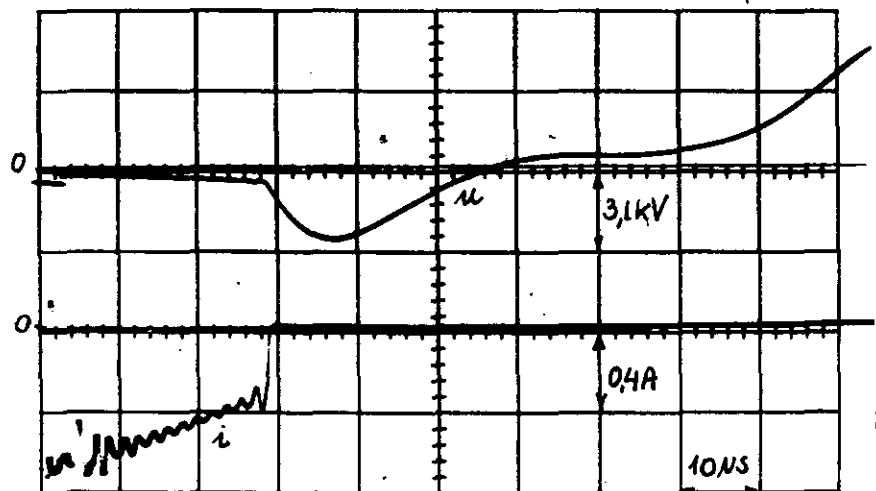

Fig. 10. B-mode chopping, $\hat{I} = 42 \text{ A}$, $C_p = 6 \text{ nF}$

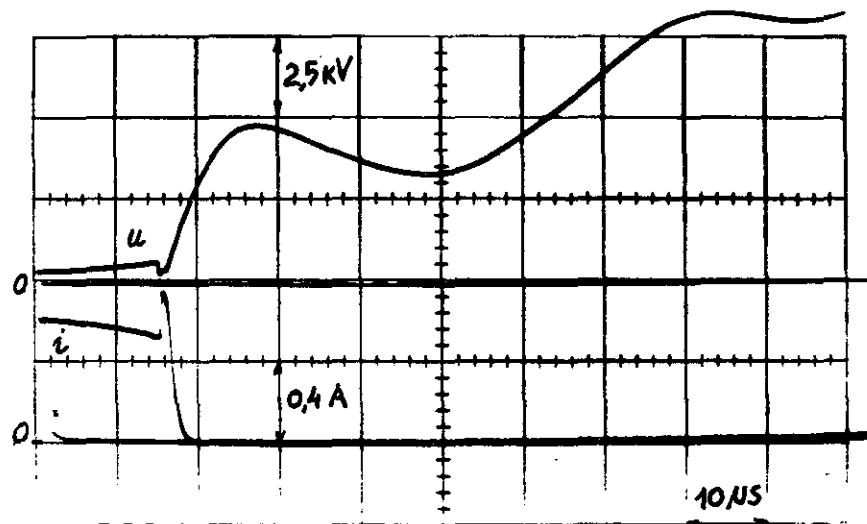

Fig. 12. C-mode chopping (by arc collapse),
 $\hat{I} = 8 \text{ A}$

All reignitions after the first current chopping were dielectric and no post-arc current could ever be concluded from our oscillograms even when the solution was < 10 mA. Reignitions after the second current zero were never observed. (First results with higher current (≈ 80 A) show longer arcs and a full current loop).

The chopping level was remarkably low when no capacitors in parallel to the breaker were connected.

Four different types of current chopping could be distinguished:

Mode A. The instability oscillation has a regular pattern. All loops are sinusoidal and the amplitude grows more or less exponentially until the zero line is (nearly) attained. This mode is frequent for short stable arcs. Typical frequencies were between 1 and 2 MHz. An example is fig. 9.

Mode B. The arc is longer and liable to elongations and collapse. More or less damped instability oscillations are frequent before the final one leads to chopping. This final oscillation often does not grow down to the zero line but the last and definite half loop breaks out. All frequencies were in 0.5 MHz range when no parallel capacitor was applied. Figs. 10 and 11 are typical examples.

Mode C. The chopping mode according to fig. 12 is introduced by arc collapse. It can only occur when the current is not far from the stability limit (see appendix). Therefore often damped instability oscillations are on the current trace before chopping, see fig. 13.

Mode D. If the arc is extremely short chopping may be abruptly without any prior oscillation as seen in fig. 14.

Besides these pronounced types often combinations of two or even three modes occurred. But as a rule it can clearly be distinguished which mode leads to chopping.

Fig. 15 shows the arc voltage after contact separation. It can be seen that after some milliseconds the stable arc with a low arc voltage transists into a more unstable mode with many elongations and collapses and a higher average arc voltage. The period of the

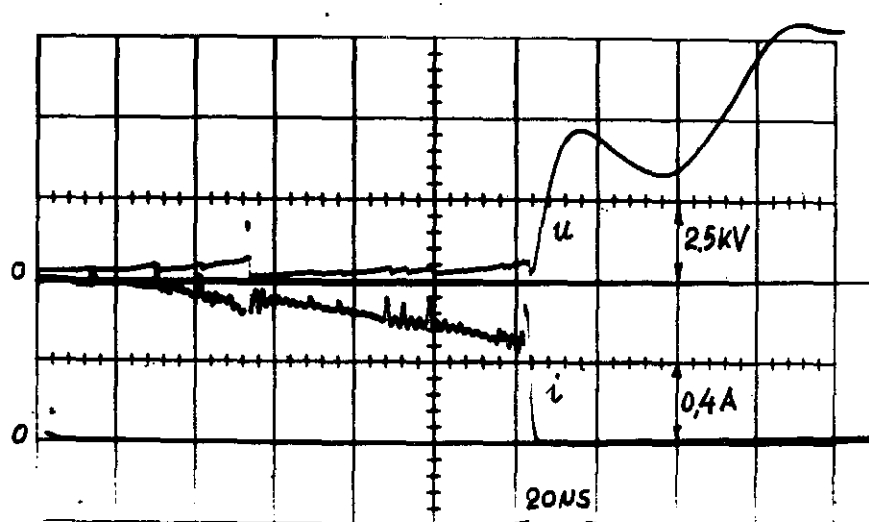

Fig. 13. C-mode chopping combined with instability oscillations,
 $\hat{I} = 8 \text{ A}$

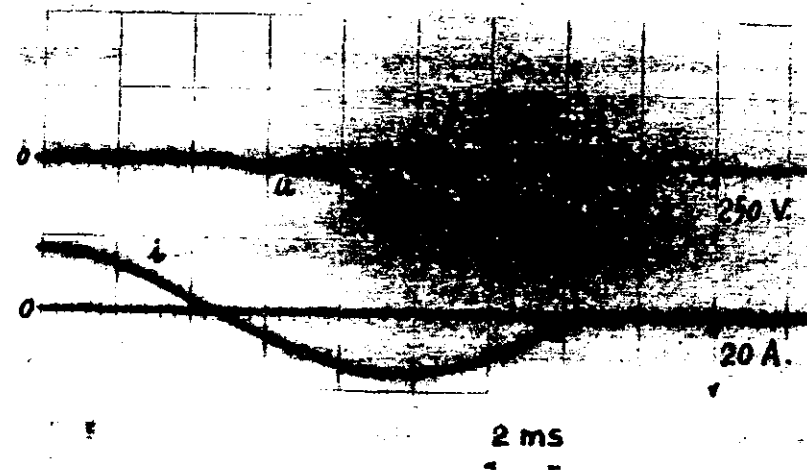

Fig. 15. Arc voltage after contact separation,
 $\hat{I} = 16 \text{ A}$

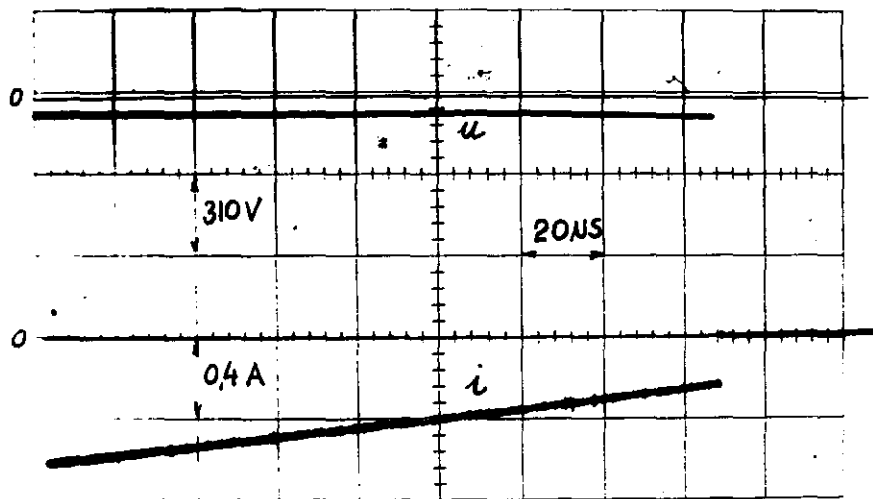

Fig. 14. Abrupt chopping, D-mode, $\hat{I} = 8 \text{ A}$

stable arc increased with increasing current to interrupt reaching from ≈ 2 ms at 8 A to ≈ 4 ms at 40 A.

The relation between chopping level and mode versus contact opening time before current zero for 8 A current to interrupt can be seen from fig. 16.

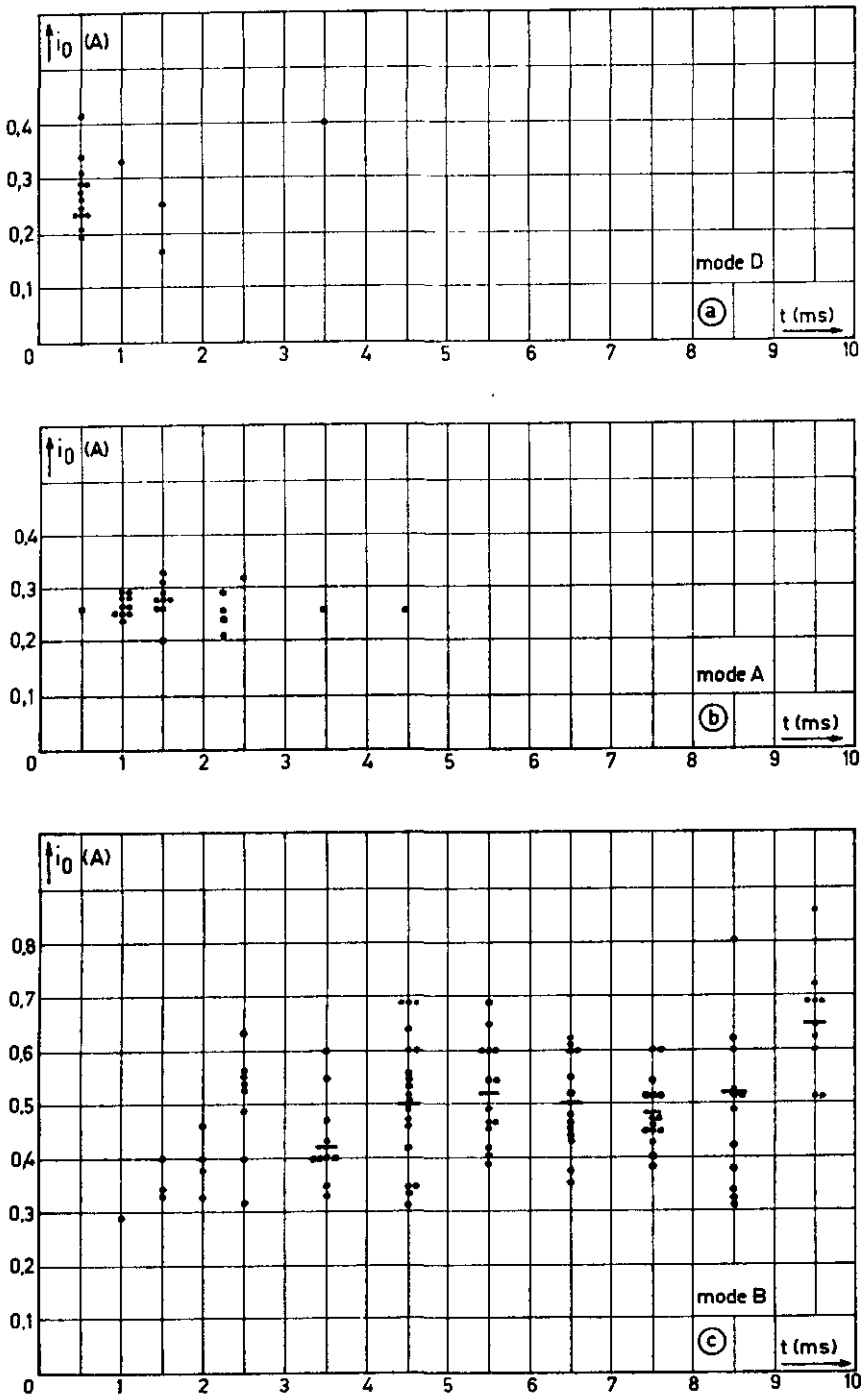

Fig. 16. Relation between chopping current i_0 and contact opening time for modes D, A and B.

These results together with detailed chopping oscillograms learn:

Mode D occurs for arcs of the order of tenths of millimetres.

Typical voltage at chopping moment was 60 V with spread within measuring inaccuracy (≈ 16 V). Chopping currents were between 0.17 and 0.42 A with average value 0.28 A.

Mode A occurs for stable arcs of 0.2 - 0.5 mm length. Voltages and arc resistances were higher, chopping currents were in the same range as mode D. Oscillating frequencies were between 1 and 2 MHz, higher values going with smallest contact gaps. This mode is more extensive investigated for checking stability criteria. Relations of voltage, current and resistance with frequency are given in fig. 17. Chopping currents were between 0.18 and 0.46 A with average of 0.27 A. With growing length the arc transists into less stable character. Chopping in such an arc is of B-mode if not collapse induced. Therefore the arc types can be called A-mode or B-mode arcs referring to the typical chopping phenomena which point out specific properties of each type.

B-mode choppings showed a larger spread in chopping current and accompanying voltages and resistances but a typical narrow frequency range around 0.5 MHz. Average chopping level was ≈ 0.5 A, spread was as indicated in fig. 16c.

B-mode choppings at first and second current zero are compared in table 2. for 8 A to interrupt. Although the arc during the second half loop was much more unstable than during the first one no significant difference in chopping level, arc resistance or frequency can be observed.

zero	gap	nr. of tests	\bar{i}_o A	S_i A	\bar{u}_o V	S_u V	\bar{R}_o Ω	S_r Ω	\bar{f}_o MHz	S_f MHz
1 st	≈ 1 mm	11	0.53	0.08	845	200	1570	260	0.50	0.02
2 nd	≈ 5 mm	8	0.46	0.06	605	150	1300	185	0.53	0.03

Table 2. B-modes at first and second current zero

In table 3 chopping conditions at different interrupted currents are compared. All values relate to the second and definite interruption. For all interrupted currents practically the same average resistance and frequencies are found.

The average chopping level is somewhat lower for higher currents to interrupt.

\hat{i}	nr. of tests	\bar{i}_o A	\bar{u}_o V	\bar{R}_o Ω	\bar{f}_o MHz	S_f MHz
A		A	V	Ω	MHz	MHz
8	67	0.49	666	1330	0.52	0.03
16	15	0.39	525	1350	0.54	0.03
30	7	0.36	455	1248	0.53	0.02
42	8	0.43	600	1410	0.53	0.03

Table 3. Mode B choppings for different currents to interrupt.

Lower instability frequencies and arc resistances accompanied by higher chopping levels were obtained by adding capacitance in parallel to the breaker, see table 4. Now most choppings were combined B and C modes with arc collapse forcing current to zero.

\hat{i}	C_P	nr. of tests	\bar{i}_o	S_i	\bar{u}_o	S_u	\bar{R}_o	S_R	\bar{f}_o	S_f
A	nF		A	A	V	V	Ω	Ω	MHz	MHz
8	6.0	27	1.55	0.35	675	175	415	115	0.30	0.05
8	12.3	9	2.56	0.58	710	155	295	83	0.23	0.05
42	6.0	11	1.43	0.37	385	125	280	85	0.33	0.07

Table 4. Influence of parallel capacitance.

These interruptions often caused high overvoltages (> 4 p.u.) affecting the protective gap across the inductive load or the breaker.

4. Discussion of results.

Arcs chopped in A or D mode are so short that a reignition and a new half current loop can be taken for sure. Therefore the B and C mode choppings are the important types for circuit breaker practice.

The results prove that chopping phenomena are fully governed by the circuit elements in the vicinity of the breaker. This is in agreement with the starting-point of the stability theory (par. 2.1).

An experimental proof of this theory is of great importance. At first because it is the only tool available to predict chopping levels, but also because a reliable theory can be used to determine which circuit elements are really involved in chopping and to measure time constants of the arcs.

Such a practical proof meets a variety of difficulties:

- except for A-mode choppings the transition from damped to growing oscillations is not clear;
- the picture is disturbed by arc collapses;
- inductivities and capacities are distributed;
- the α -value for the u-i-relation is not a constant but varies not

only for each individual arc but also during its lifetime;
 - one may expect that the arc time constant is not a constant.

It seems however reasonable to assume that during a reignition the same circuit elements L and C are involved as during instability oscillation provided the reignition oscillation has a higher frequency. In our circuits with or without parallel capacitors the "first parallel oscillation" had a much higher frequency than the chopping oscillations (see table 1). It may therefore be concluded that the involved circuit inductivity L was much smaller than the virtual arc inductance θR_a . This simplifies the stability criterium (5) to

$$R_a C \leq \theta / \alpha \quad (7)$$

Then study of detailed oscillograms of A-modes and clear B-modes can yield values ω_o , α and R_a for each chopping current i_o . Using (6) and (7) at the inset of instability, so $\omega_o = \sqrt{\alpha/\theta} = 1/\sqrt{\theta R_a C_p}$, values for θ and C_p can be deducted.

This method was applied for interruption without parallel capacitors. Results are in table 5. Average α values at inset of instability were 1.3 and 2.5 for A- and B-mode respectively.

Mode	Nr. of tests	f_i MHz	S_f MHz	R_a Ω	S_R Ω	θ μs	S_θ μ	C pF	S_c pF
A	10	1.40	0.15	713	204	0.13	0.03	154	43
B	16	0.52	0.03	955	173	0.47	0.11	225	71

Table 5. Application of stability theory on experimental results.

The relations between arc resistance, voltage, current and frequencies at the moment of current chopping are given in fig. 17 for 38 samples of A-mode choppings.

In fig. 17c also the line $R_a = 1/w_0^2 \theta C_p$ is plotted where $\theta = 0.13 \mu s$ and $C_p = 154 pF$ according to A-mode average values of table 5. This yields:

$$R_a = 1,3 \cdot 10^{15} f_0^{-2}$$

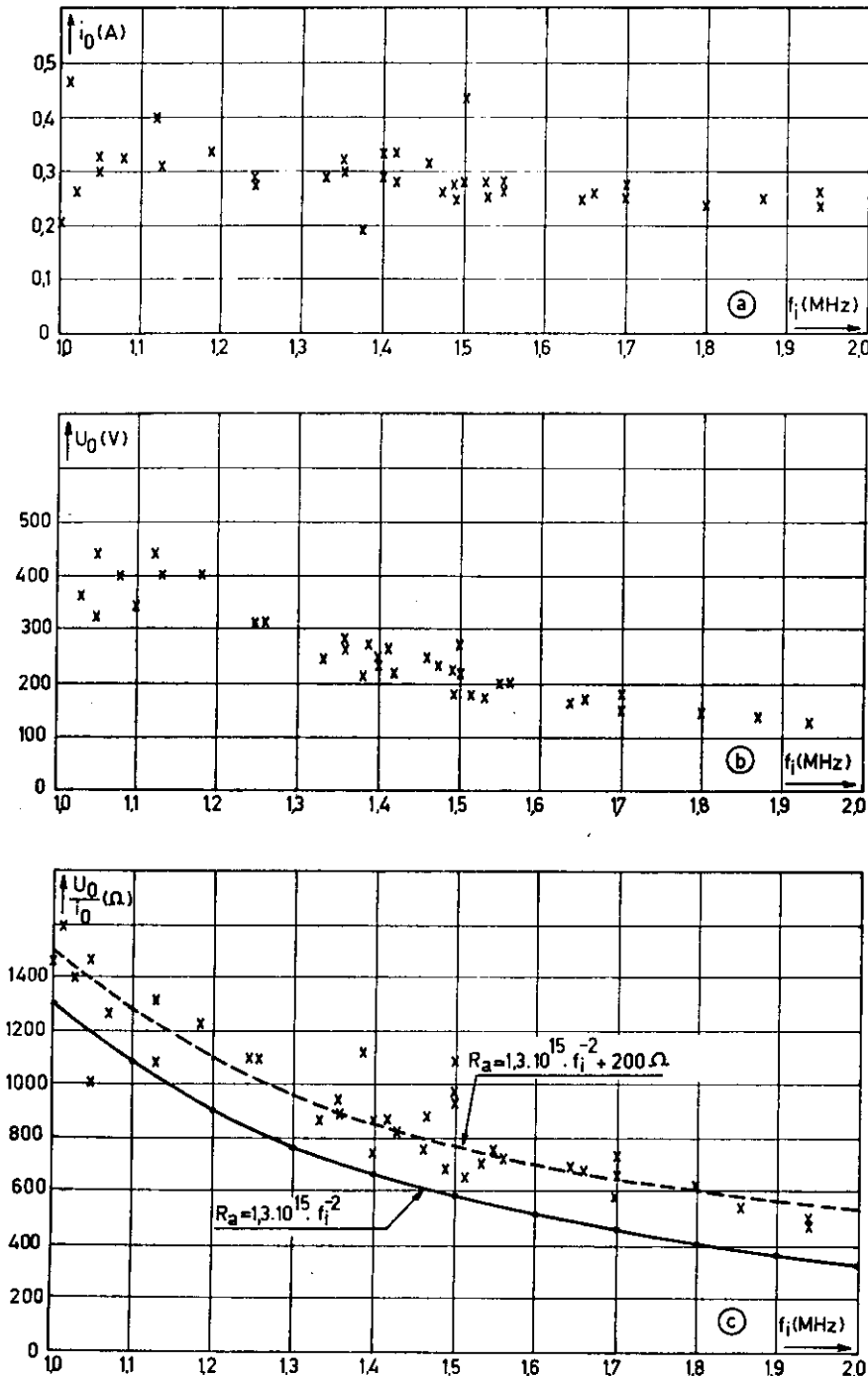

Fig. 17. Chopping current (a), arc voltage (b) and arc resistance (c) versus frequency for A-mode choppings.

This line proves a good agreement with theory. A still better agreement gives the dotted line

$$R_a = 1,3 \cdot 10^{15} f_o^{-2} + 200\Omega$$

The more or less constant deviation of $\approx 200\Omega$ can for the most part be explained by the fact that table 5 values were real instability onset values. The crossed points in fig. 17c indicate not the onset of instability but the resistance at the moment of real current chopping. (Independently from this effect the question arises what is the influence of the cathode and anode fall on the stability criterium for such short arcs).

Remarkable is the difference in calculated capacitance from A and B-mode. Distinguishing column and electrode resistances leads also to somewhat higher values C_p than given in table 5. This is more effective for A-mode choppings because here the chopping level as well as the arc resistance are lower. But the difference cannot completely be explained by this reason. The conclusion must be that a greater part of the source side capacitance is involved in the B-mode oscillation with its lower frequency. This agrees with the opinion of Gardner and Urwin [11].

Another way to deduce effective capacitance is a study of the current and voltage traces at the very moment of chopping. During the last and definite negative loop of the oscillation the current fall and voltage rise are determined by the effective parallel capacitance. Hereafter the restriking voltage starts, at first moment principally governed by the source side capacitance. If the chopped main current would commutate in the same capacitance this would result in an increasing voltage rise. The contrary is observed on oscillograms.

Only a few oscillograms could be analyzed to this purpose. They showed $C_p \approx 220 \text{ pF}$ and $C_s \approx 800 \text{ pF}$ which is a good agreement for such rough estimates.

The fact that all B-modes were in a narrow frequency range makes a check as performed in fig. 17c for the A-mode unusable.

This checking method did not satisfy at all when a lumped low inductance capacitor of 6000 or 12,300 pF was connected in parallel. Computed C values were only 0.25 - 0.5 of really added. Certainly the many obstacles mentioned above are for a great part responsible. There was primarily the fact that nearly every chopping was induced by arc collapse. But it is also very doubtful whether the quickly elongating arcs might be seen as quasi-stable and whether for such arcs the α -factor has any sense.

Up to now it can only be concluded that a proof of the stability theory for less ideal arcs was not successful.

5. Conclusions.

- When interrupting small currents in SF₆ two types of arcs occurred successively. At first a stable arc called A-mode arc burns with relatively low voltage (typical values between 50 and 500 V). Hereafter the arc transits in a more unstable B-mode with many elongations and collapses and higher average arc voltage.
- Extremely short A-mode arcs ($\approx 0.1 - 0.2$ mm) can chop abruptly without any oscillations.
- Longer A-mode arcs chop with h.f. oscillation. Typical values were between 1 and 2 MHz. Results were in good agreement with stability theory. From this an arc time constant of ≈ 0.15 μ s could be deduced.
- Transition into B-mode occurred at 0.5 - 1 mm, longer gaps being joined to higher currents to interrupt. Frequencies of instability oscillations were 2 to 4 times lower than for A-mode. All values were around 0.5 MHz when no parallel capacitance was added. From stability theory a time constant of ≈ 0.5 μ s was deduced. This theory, however, could not be proved from these tests.

- Typical chopping level for A-mode was ≈ 0.3 A, for B-mode ≈ 0.5 A independent of current to interrupt or arc length.
- Frequencies and chopping level are determined by circuit elements in direct vicinity to the breaker and can be influenced by capacitance in parallel to the breaker. Circuit elements involved cannot be deduced from lower frequency oscillations.
- The excellent quenching and insulating properties of SF₆ appear in low arc voltages and low chopping levels, the fact that never thermal reignitions occur and a high dielectric strength over small contact gaps. This includes the negative effect that the breaker has no tendency to limit its overvoltages.
- Relatively low parallel capacitance increased tendency to arc elongation and collapse and led to higher chopping currents and overvoltages. Applying stability theory in these cases was unsuccessful.
- Further study is needed to determine how practical network elements such as cables, lines, transformers and reactors are involved in chopping phenomena.

6. Acknowledgement.

The author would like to thank Mr. Martien Hendriks who performed the experiments as part of his M.Sc.degree work, Mr. Ton Wilmes for his assistance in solving programming puzzles and the Holec-Schakelaargroep for granting the circuit breaker model.

Literature

- (1) Baltensperger, P. und P. Schmid
LICHTBOGENSTROM UND ÜBERSpanNUNGEN BEIM ABSCHALTEN KLEINER
INDUKTIVER STRÖME IN HOCHSPANNUNGSNETZEN.
Bull. des Schweizerischen elektrotechnischen Vereins,
Vol. 46(1955), p. 1-13.
- (2) Nöske, H.
ZUM STABILITÄTSPROBLEM BEIM ABSCHALTEN KLEINER INDUKTIVER
STRÖME MIT HOCHSPANNUNSSCHALTERN.
Arch. Elektrotech., Vol. 43(1957), p. 114-133.
- (3) Kopplin, H.
UNTERSUCHUNG DES LÖSCHVERHALTENS EINES 110-kV-EXPANSIONS-
SCHALTERS MIT HILFE EINER NACHSTROM-MESSAPARATUR.
Diss. Technische Universität Berlin, 1959.
- (4) Rizk, F.A.M.
INTERRUPTION OF SMALL INDUCTIVE CURRENTS WITH AIR-BLAST
CIRCUIT BREAKERS.
Diss. Chalmers Tekniska Högskola, Göteborg, 1963.
- (5) van den Heuvel, W.M.C.
INTERRUPTION OF SMALL INDUCTIVE CURRENTS IN A.C. CIRCUITS.
Diss. Eindhoven University of Technology, 1966.
- (6) van den Heuvel, W.M.C. and D.Th.J. ter Horst
INTERRUPTING SMALL INDUCTIVE CURRENTS WITH OIL FILLED BREAKERS.
Allis-Chalmers Eng. Rev., Vol. 30(1965), No. 3, p. 8-12 (part I)
and No. 4, p. 26-31 (part II).
- (7) Young, A.F.B.
SOME RESEARCHES ON CURRENT-CHOPPING IN HIGH-VOLTAGE CIRCUIT-
BREAKERS.
Proc. Inst. Electr. Eng., Vol. 100(1953), Part II, p. 337-361.
- (8) Damstra, G.C.
CURRENT CHOPPING AND OVERVOLTAGES IN RELATION TO SYSTEM
PARAMETERS.
In: Proc. 20th Int. Conf. on Large High Voltage Electric
Systems (CIGRÉ), Paris, 1964. Paper No. 120.
- (9) Berneryd, S. et al.
SWITCHING OF SHUNT REACTORS: Comparison between field and
laboratory tests.
In: Proc. 26th Int. Conf. on Large High Voltage Electric
Systems (CIGRÉ), Paris, 1976. Paper No. 13-04.
- (10) Murano, M. et al.
CURRENT CHOPPING PHENOMENA OF MEDIUM VOLTAGE CIRCUIT BREAKERS.
IEEE Trans. Power Appar. & Syst., Vol. PAS-96(1977), p. 143-149.
- (11) Gardner, G.E. and R.J. Urwin
ARC INSTABILITY AND CURRENT CHOPPING IN AN AIR-BLAST
INTERRUPTER.
Proc. Inst. Electr. Eng., Vol. 124(1977), p. 619-627.

- (12) Gardner, G.E. and R.J. Urwin
PERFORMANCE AND TESTING OF MULTI-UNIT CIRCUIT BREAKERS SWITCHING
LOW INDUCTIVE CURRENTS.
Proc. Inst. Electr. Eng., Vol. 125(1978), p. 230-236.
- (13) Komarov, A.N. et al.
EHV SHUNT REACTOR INDUCTIVE CURRENTS SWITCHING OFF.
In: Proc. 27th Int. Conf. on Large High Voltage Electric
Systems (CIGRÉ), Paris, 1978. Paper No. 13-06.
- (14) van Sickle, R.C.
BREAKER PERFORMANCE STUDIED BY CATHODE RAY OSCILLOGRAMS.
Trans. Amer. Inst. Electr. Eng., Vol. 54(1935), p. 178-184.
- (15) Puppikofer, H.
DER EINFLUSS DES SCHALTERS AUF DIE WIEDERKEHRENDE SPANNUNG
UND SEIN VERHALTEN IM NETZ.
Bull. des Schweizerischen elektrotechnischen Vereins,
Vol. 30(1939), p. 334-342. Berichtigung p. 380.
- (16) Rieder, W.
ARC-CIRCUIT INTERACTION NEAR CURRENT ZERO AND CIRCUIT-BREAKER
TESTING.
IEEE Trans. Power Appar. & Syst., Vol. PAS-91(1972), p. 705-713.
- (17) Mayr, O.
THEORIE DES STATISCHEN UND DYNAMISCHEN LICHTBOGENS.
Arch. Elektrotech., Vol. 37(1943), p. 588-608.
- (18) Murano, M. et al.
THREE-PHASE SIMULTANEOUS INTERRUPTION IN INTERRUPTING INDUCTIVE
CURRENT USING VACUUM SWITCHES.
IEEE Trans. Power Appar. & Syst., Vol. PAS-93(1974), p. 272-280.
- (19) Panek, J. and K.G. Fehrle
OVERVOLTAGE PHENOMENA ASSOCIATED WITH VIRTUAL CURRENT CHOPPING
IN THREE PHASE CIRCUITS.
IEEE Trans. Power Appar. & Syst., Vol. PAS-94(1975), p. 1317-1325.
- (20) Damstra, G.C.
INFLUENCE OF CIRCUIT PARAMETERS ON CURRENT CHOPPING AND OVERVOLTAGES
IN INDUCTIVE M.V. CIRCUITS.
In: Proc. 26th Int. Conf. on Large High Voltage Electric
Systems (CIGRÉ), Paris, 1976. Paper No. 13-08.
- (21) Edels, H.
THE GLOW-TO-ARC TRANSITION IN THE COLUMN AND AT THE CATHODE
OF A HYDROGEN DISCHARGE.
In: Proc. 3rd Int. Conf. on Ionization Phenomena in Gases,
Venezia, 1957. P. 1-11.
- (22) Edels, H. and W.A. Gambling
THE HIGH-PRESSURE GLOW DISCHARGE IN AIR.
Br. J. Appl. Phys., Vol. 5(1954), p. 36-39.

- (23) Daalder, J.E.
CATHODE EROSION OF METAL VAPOUR ARCS IN VACUUM.
Diss. Eindhoven University of Technology, 1978.
- (24) Holmes, F.A.
AN EMPIRICAL STUDY OF CURRENT CHOPPING BY VACUUM ARCS.
In: Proc. IEEE Power Engineering Society Winter Meeting,
New York, N.Y., 27 Jan. - 1 Febr. 1974. Paper C 74 088-1.
- (25) Farrall, G.A. and J.D. Cobine
STABILITY OF ARCS IN GASES.
J. Appl. Phys., Vol. 36(1965), p. 53-56.
- (26) Pflaum, E. und W. Waterschek
DIE STROMVERFORMUNG DURCH DIE BOGENSPANNUNG UND IHRE BEDEUTUNG
FÜR DAS PRÜFEN VON HOCHSPANNUNGS-LEISTUNGSSCHALTERN.
Elektrotech. Z. ETZ-A, Vol. 92(1971), p. 169-173.
- (27) Roguski, A.T.
LABORATORY TEST CIRCUITS FOR PREDICTING OVERVOLTAGES WHEN
INTERRUPTING SMALL INDUCTIVE CURRENTS WITH AN SF₆ CIRCUIT
BREAKER.
In: IEEE Power Engineering Society Summer Meeting, Vancouver,
B.C., 15-20 July 1979. Paper F 79 760-0. To be published in:
IEEE Trans. Power Appar. & Syst.

**EINDHOVEN UNIVERSITY OF TECHNOLOGY
THE NETHERLANDS
DEPARTMENT OF ELECTRICAL ENGINEERING**

Reports:

- 93) Duin, C.A. van
DIPOLE SCATTERING OF ELECTROMAGNETIC WAVES PROPAGATION THROUGH A RAIN MEDIUM. TH-Report 79-E-93. 1979. ISBN 90-6144-093-9
- 94) Kuijper, A.H. de and L.K.J. Vandamme
CHARTS OF SPATIAL NOISE DISTRIBUTION IN PLANAR RESISTORS WITH FINITE CONTACTS. TH-Report 79-E-94. 1979. ISBN 90-6144-094-7
- 95) Hajdasinski, A.K. and A.A.H. Damen
REALIZATION OF THE MARKOV PARAMETER SEQUENCES USING THE SINGULAR VALUE DECOMPOSITION OF THE HANKEL MATRIX. TH-Report 79-E-95. 1979. ISBN 90-6144-095-5
- 96) Stefanov, B.
ELECTRON MOMENTUM TRANSFER CROSS-SECTION IN CESIUM AND RELATED CALCULATIONS OF THE LOCAL PARAMETERS OF Cs + Ar MHD PLASMAS. TH-Report 79-E-96. 1979. ISBN 90-6144-096-3
- 97) Worm, S.C.J.
RADIATION PATTERNS OF CIRCULAR APERTURES WITH PRESCRIBED SIDELobe LEVELS. TH-Report 79-E-97. 1979. ISBN 90-6144-097-1
- 98) Kroezen, P.H.C.
A SERIES REPRESENTATION METHOD FOR THE FAR FIELD OF AN OFFSET REFLECTOR ANTENNA. TH-Report 79-E-98. 1979. ISBN 90-6144-098-X
- 99) Koonen, A.M.J.
ERROR PROBABILITY IN DIGITAL FIBER OPTIC COMMUNICATION SYSTEMS. TH-Report 79-E-99. 1979. ISBN 90-6144-099-8
- 100) Naidu, M.S.
STUDIES ON THE DECAY OF SURFACE CHARGES ON DIELECTRICS. TH-Report 79-E-100. 1979. ISBN 90-6144-100-5
- 101) Verstappen, H.L.
A SHAPED CYLINDRICAL DOUBLE-REFLECTOR SYSTEM FOR A BROADCAST-SATELLITE ANTENNA. TH-Report 79-E-101. 1979. ISBN 90-6144-101-3
- 102) Etten, W.C. van
THE THEORY OF NONLINEAR DISCRETE-TIME SYSTEMS AND ITS APPLICATION TO THE EQUALIZATION OF NONLINEAR DIGITAL COMMUNICATION CHANNELS. TH-Report 79-E-102. 1979. ISBN 90-6144-102-1
- 103) Roer, Th.G. van de
ANALYTICAL THEORY OF PUNCH-THROUGH DIODES. TH-Report 79-E-103. 1979. ISBN 90-6144-103-X
- 104) Herben, M.H.A.J.
DESIGNING A CONTOURED BEAM ANTENNA. TH-Report 79-E-104. 1979. ISBN 90-6144-104-8

EINDHOVEN UNIVERSITY OF TECHNOLOGY
THE NETHERLANDS
DEPARTMENT OF ELECTRICAL ENGINEERING

Reports:

- 105) Videc, M.F.
STRALINGSVERSCHIJNSELEN IN PLASMA'S EN BEWEGENDE MEDIA: Een geometrisch-
optische en een golfzonebenadering.
TH-Report 80-E-105. 1980. ISBN 90-6144-105-6
- 106) Hajdasiński, A.K.
LINEAR MULTIVARIABLE SYSTEMS: Preliminary problems in mathematical
description, modelling and identification.
TH-Report 80-E-106. 1980. ISBN 90-6144-106-4
- 107) Heuvel, W.M.C. van den
CURRENT CHOPPING IN SF₆.
TH-Report 80-E-107. 1980. ISBN 90-6144-107-2
- 108) Etten, W.C. van and T.M. Lammers
TRANSMISSION OF FM-MODULATED AUDIOSIGNALS IN THE 87.5 - 108 MHz
BROADCAST BAND OVER A FIBER OPTIC SYSTEM.
TH-Report 80-E-108. 1980. ISBN 90-6144-108-0