

Cogging compensating piecewise iterative learning control for variable setpoints with application to a wafer stage

Citation for published version (APA):

Berkel, van, K. (2006). *Cogging compensating piecewise iterative learning control for variable setpoints with application to a wafer stage*. (DCT rapporten; Vol. 2006.131). Technische Universiteit Eindhoven.

Document status and date:

Published: 01/01/2006

Document Version:

Publisher's PDF, also known as Version of Record (includes final page, issue and volume numbers)

Please check the document version of this publication:

- A submitted manuscript is the version of the article upon submission and before peer-review. There can be important differences between the submitted version and the official published version of record. People interested in the research are advised to contact the author for the final version of the publication, or visit the DOI to the publisher's website.
- The final author version and the galley proof are versions of the publication after peer review.
- The final published version features the final layout of the paper including the volume, issue and page numbers.

[Link to publication](#)

General rights

Copyright and moral rights for the publications made accessible in the public portal are retained by the authors and/or other copyright owners and it is a condition of accessing publications that users recognise and abide by the legal requirements associated with these rights.

- Users may download and print one copy of any publication from the public portal for the purpose of private study or research.
- You may not further distribute the material or use it for any profit-making activity or commercial gain
- You may freely distribute the URL identifying the publication in the public portal.

If the publication is distributed under the terms of Article 25fa of the Dutch Copyright Act, indicated by the "Taverne" license above, please follow below link for the End User Agreement:

www.tue.nl/taverne

Take down policy

If you believe that this document breaches copyright please contact us at:

openaccess@tue.nl

providing details and we will investigate your claim.

Cogging Compensating Piecewise Iterative Learning Control for variable setpoints with application to a wafer stage

Koos van Berkel

DCT 2006.131

Traineeship report

Coach(es): Iuliana Rotariu

Supervisor: Maarten Steinbuch

Technische Universiteit Eindhoven
Department Mechanical Engineering
Dynamics and Control Technology Group

Eindhoven, November, 2006

Cogging Compensating Piecewise Iterative Learning Control for variable setpoints with application to a wafer stage

Koos van Berkel¹, Iuliana Rotariu² and Maarten Steinbuch³

Abstract—Iterative Learning Control (ILC) is an effective control technique for motion systems that perform repetitively the same trajectory (setpoint), e.g. a wafer stage. The result of the learning procedure is a feedforward signal that perfectly compensates all deterministic dynamics in the system for the learned setpoint performed at a specific start position. For other setpoints and start positions, the learned feedforward signal will not be perfect, because the learned deterministic dynamics are setpoint- and position-dependent (e.g. cogging). This means that the learning procedure needs to be performed for every change in setpoint and start position, which costs time that is valuable in a wafer stage. In this paper Cogging Compensating Piecewise ILC (CCPILC) is proposed to use one learned feedforward signal for different setpoints and start positions without losing performance. It divides one feedforward signal into a setpoint dependent part and a position-dependent part, such that both parts can be adapted individually according to the desired setpoint and start position.

Index Terms—ILC, Learning, Control, Piecewise ILC, variable, setpoint, deterministic dynamics, position-dependent, cogging, wafer stage

I. INTRODUCTION

THE integrated circuit (IC) industry require increasing positioning precision for smaller becoming IC's. The essential steps in the manufacturing process of IC's are performed by lithographic machines called wafer scanners. An important module of these machines is the wafer stage, which is a 6 DOF motion system that positions the silicon wafer with respect to the illuminating optics, see figure 1. To meet the positioning tolerances in the order of nanometers, better control systems than conventional PD feedback and rigid body feedforward controllers are demanded. Iterative Learning Control (ILC) is an effective control technique for improving the tracking performance of such motion systems which perform repeatedly the same setpoint [1]. This technique iteratively learns a new feedforward signal using control information of the previous iteration. Although ILC increases the tracking performance of the system, it has liability to deal with changes of the setpoint or trajectory, see figure 2. This implies that the iterative

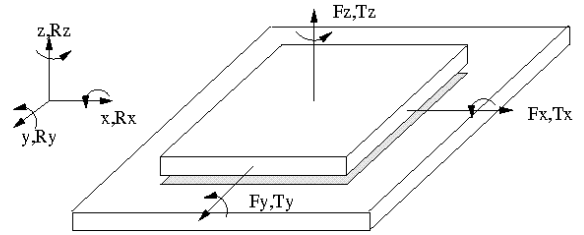

Fig. 1. Schematic view of a wafer stage: the precision short-stroke stage (6 DOF) on top of the long-stroke stage.

learning process has to be repeated for every different setpoint, which costs time [2], [3]. When applying ILC to a wafer stage, this can be a major problem since the size of the dies constantly changes [2], [3]. According to the size of the die, the length of the constant velocity interval in the setpoint will vary, because the illumination is done while the stage is moving with constant velocity, see figure 2.

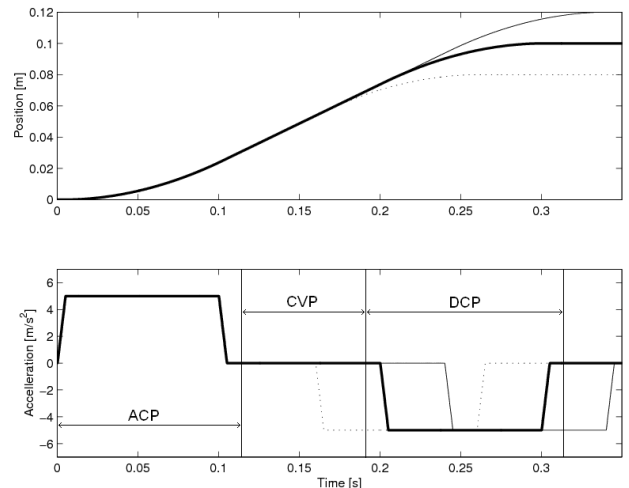

Fig. 2. Setpoint with different illumination lengths [2]. The division into ACP, CVP and DCP is shown in the bottom part of the figure.

¹Dept. of Mechanical Engineering, Eindhoven University of Technology, P.O. Box 513, 5600 MB Eindhoven, NL, E-mail: k.v.berkel@student.tue.nl

²Australian Centre for Field Robotics, University of Sydney, The Rose Street Building J04, NSW2006 Australia, E-mail: i.rotariu@acfr.usyd.edu.au

³ Dept. of Mechanical Engineering, Eindhoven University of Technology, P.O. Box 513, 5600 MB Eindhoven, NL, E-mail: m.steinbuch@tue.nl

A possible solution for this has been proposed in [2], [3], [4]

and consists of designing the Piecewise ILC which leads to one learned feedforward signal suitable for different lengths of the illumination interval. This technique is developed based on the Time Varying ILC (TVILC) [2], [3], [4] that uses the time-frequency (TF) analysis of the servo error [5], [6]. The TVILC scheme [2], [3], [4] is the same as for standard ILC, the only difference being that the fixed robustness Q -filter becomes an adaptive filter whose bandwidth varies according to the TF content of the servo error: at time instants where there are deterministic dynamics, the bandwidth of the Q -filter is increased in order to learn these deterministic effects and where there is only noise, the bandwidth is decreased to avoid "learning" noise.

This results in a learned feedforward signal that shows dynamics in the acceleration compensation part (ACP) and deceleration compensation part (DCP), while in between only zeroes are found [2], [3]. The Piecewise ILC splits a learned feedforward signal into an ACP, DCP and a constant velocity part (CVP), see figure 2. In order to track setpoints with different lengths of the illumination interval, the CVP of the learned feedforward signal will be adapted in length by inserting or subtracting zeroes [2], [3]. Note that in the ACP and DCP small parts of the illumination interval are taken, because the beginning and the end of this interval contain dynamics in the learned feedforward signal.

Two types of experiments performed in [2] show that using the Piecewise ILC for setpoints at different wafer-positions results in a less good tracking performance than applying ILC for every different wafer position: (1) The illumination lengths are varied while the start position of the setpoint is kept fixed, see figure 3. (2) The illumination length is fixed, but the start position is varied, see figure 4. This can be explained by the following: after application of ILC for a specific setpoint on the considered wafer stage, its dynamics and position-dependent disturbances will be represented in the learned feedforward signal. When this learned feedforward signal is used to track the same setpoint at different wafer-positions, the encountered position-dependent disturbances may be different and thus the signal less suitable [2]. In figure 3 the DCP is shifted in position in order to prolong the illumination interval. While the dynamics are perfectly learned for the first part of the setpoint, the part which is adapted shows larger servo errors. Larger errors may occur over the entire setpoint when the start position on the stage is changed as can be seen in figure 4.

It is important to point out that these position-dependent disturbances are due to the cogging force caused by the permanent magnetic linear motors (PMLM's). These motors actuate the long-stroke stage on which the short-stroke is attached, see figure 1. During movement of the long-stroke stage, coil-transitions cause slight changes in the force coming from the PMLM's acting on the short-stroke stage.

The link between position-dependent disturbances and cogging forces can also be validated observing a periodicity in the RMS values of the servo errors in Figure 5. The servo errors are obtained with one learned feedforward signal used on different start positions (figure 4). A period of 20 [mm] is observed, which is exactly the coil-spacing of the linear

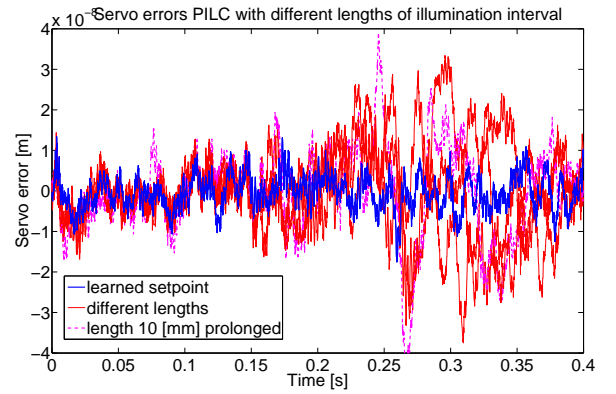

Fig. 3. Results piecewise ILC with various illumination lengths [2].

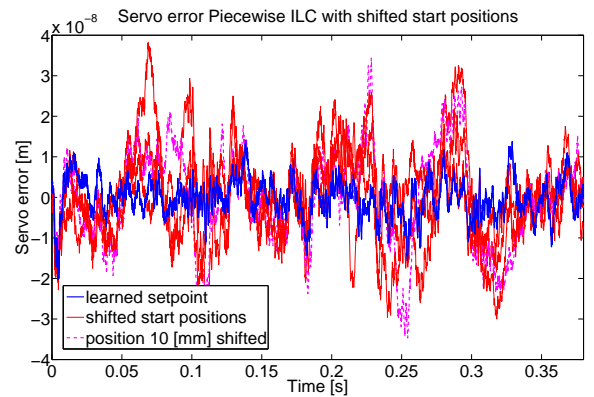

Fig. 4. Results piecewise ILC with various start positions [2].

motors.

In this paper the Cogging Compensating Piecewise ILC (CCPILC) is introduced and its improvement with respect to Piecewise ILC is shown and discussed. In short, the CCPILC designs a learned feedforward signal that consists of an ACP, CVP, and respectively DCP signal component as described above and a cogging compensation force (CCF) along the entire setpoint. It will be shown that with these four elements any learned feedforward signal can be built to track different illumination lengths and start positions. The performance of CCPILC is equivalent to that of standard ILC, where standard ILC has to perform its learning procedure for all setpoints of different illumination length and all setpoints that operate on different positions on the stage. The main advantage of CCPILC is that the iterative learning procedure has only to be performed *once* for all different setpoints without learning again.

This paper is organized as follows. Section II briefly describes the concept of Standard ILC and Piecewise ILC. Section III shows the model of the non-linear plant used throughout this paper including the position-dependent cogging force. The learned feedforward signal is analyzed and extracted in section IV and built for different setpoints and start positions in section V. In section VI comparisons with standard ILC are made for different setpoints. Section ?? briefly discusses the application of CCPILC with TVILC. The last section summarizes conclusions and recommendations.

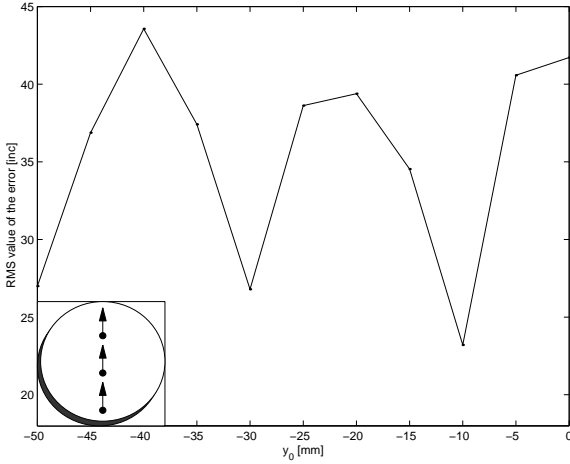

Fig. 5. Root mean square (RMS) of servo errors obtained for different start positions [2].

II. CONCEPT OF STANDARD ILC AND PIECEWISE ILC

A. Standard ILC

ILC is based on the principle of using the tracking error of a system in order to obtain an ideal feedforward input to reduce the tracking error of the system [1]. Next the concept of standard ILC is shortly introduced in accordance with figure 6. Let the plant P be a causal linear time invariant (LTI) dynamical system. In the following chapter, more realistically, the plant will be extended to a causal non-linear time varying (NLTV) dynamical system. C is a feedback controller which insures the stability of the closed loop system. The desired setpoint r is defined on the interval (t_0, t_f) , where $t_f < \infty$ and the initial conditions are the same at the beginning of each iteration.

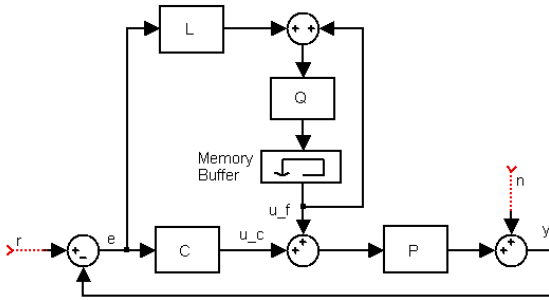

Fig. 6. A block schematic of Standard and Time Varying ILC

The goal of ILC design is to produce the learned feedforward signal u^* such that $r = Pu^*$. We seek a sequence of inputs with the property that $u^* = \lim_{k \rightarrow \infty} u_k = u^*$, where the index k is the iteration trial. A prototype update law that implements ILC by updating the past iteration input u_k on the basis of the past error is [4].

$$u_{k+1} = Q(I - LS_p)u_k + LSr \quad (1)$$

For optimal learning, the learning filter L has to approximate the inverse of the modeled process sensitivity function $S_p(s)$ ($S_p = \frac{P}{I+PC}$) [4]. In case of a proper minimum phase modeled process sensitivity function, one can compute and implement its inverse without any problems. For non-minimum phase plants, a stable approximation of the real inverse is used. The robustness filter Q is a low-pass filter which has no effect in the frequency band where the inverse of the process sensitivity approximates the real inverse well enough and has small values for the rest of the frequencies [4].

B. Piecewise ILC

In this section we introduce the Time Varying ILC (TVILC) technique and, based on it, the Piecewise ILC method will be easily understood. For TVILC design, the fixed robustness filter $Q(s)$, of standard ILC (steady-state filter, iteration independent) is replaced with a time varying Q -filter $Q_k(s, \bar{t}, \Omega_k(\bar{t}))$. This low-pass filter is a zero-phase Butterworth filter of order n and cut-off frequency $\Omega_k(\bar{t})$, where $\bar{t} \in [t_{0(k)}, t_{0(k)} + T]$, $t_{0(k)}$ the initial time of the k^{th} iteration and T the time required to perform the trajectory. The cut-off frequency Ω is therefore time varying throughout the length of each iteration [6].

The bandwidth profile of the cut-off frequency $\Omega_k(\bar{t})$ design is based on the time-frequency (TF) analysis of the servo error, analysis that will clearly show if and where in time there is deterministic dynamics and where there is only noise. This will enable an optimal trade-off between learning all deterministic dynamics present in the error signal and avoiding noise amplification. In other words, at time instants where there are deterministic dynamics, the bandwidth of the Q -filter is increased in order to learn these deterministic effects and where there is only noise, the bandwidth is decreased to avoid noise amplification [3].

By applying the TVILC on the real system [2] a typical learned feedforward signal (LFF) as depicted in figure 7 is obtained. Note that the acceleration feedforward is subtracted in order to improve the scaling. Remarkable is the presence of deterministic system dynamics in the ACP and DCP, while in the CVP approximately only zeroes are found. This system property was a sufficient reason to explore the possibility to design one learned feedforward signal suitable for different scan lengths resulting in Piecewise ILC. Because no dynamics are found in the CVP, this part can be adapted in length by inserting or subtracting zeroes [2], [3]. This way, setpoints with different lengths of illumination interval can be constructed with one LFF, without learning again.

Although the Piecewise ILC leads to design one LFF suitable for different setpoints without amplifying noise [2], [3], it does not compensate for position-dependent dynamics, see figure 3 and 4. In the next section we will explain the connection between the observed position-dependent dynamics and the cogging force that is caused by the long-stroke stage actuators on which the short-stroke stage is attached, see figure 1

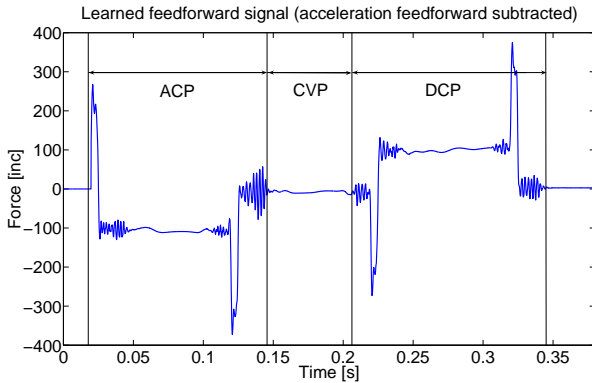

Fig. 7. Learned feedforward signal after applying TVILC.

III. WAFER STAGE SHORT-STROKE MODEL WITH COGGING

We have already shown that understanding and controlling non-linear position-dependent dynamics while tracking movements on different positions is still an issue. For modeling purposes, the linear behavior of the plant can be approximated accurately in a state-space description, but the significant non-linear position-dependent cogging is absent. In this section we shall explain and model the cogging force, then tune it in order to match the system's position-dependent dynamics and finally integrate it in the ILC block diagram shown in figure 6. Furthermore we shall analyze and model the noise in the real system and take it into account when designing the cut-off frequency of the Q -filter. The considered motion system is the SIRE T5 while scanning in the y -direction.

A. Cogging

The position-dependent cogging force is caused by the PMLM's actuating the long-stroke stage on which the short-stroke stage is attached, see figure 1. A schematic structure of such a motor is depicted in figure 8. The mover on top consists of permanent magnets attached on a ferromagnetic backing. The stator at the bottom is a transversally slotted iron part, with a single layer of three-phase winding rolled in distribution on the iron cores. A three-phase AC current activates the stator coils and may produce a net force to actuate the mover.

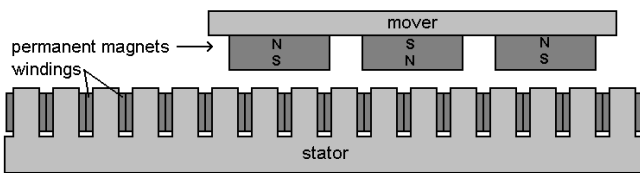

Fig. 8. Schematic structure of a permanent magnet linear motor.

At certain relative positions of the mover, cogging forces arise as a result of magnetic interaction between the permanent magnets and the iron cores as they try to align to a stable position. The resultant force is independent of any winding

current and exhibits a periodic relationship with respect to the relative position between the magnets and the iron cores [7], [8], [9]. This results in a position-dependent force ripple. Another contribution to this force ripple is the reluctance force caused by the coils. As the permanent magnets move over the coils, the self-inductance of the windings varies depending on the winding current [10], [11]. This force ripple exhibits the same periodic relationship as the cogging force. For modeling purposes, both contributions are taken together as one position-dependent disturbance, independent of the current. The reason for this is that the contribution of the reluctance force is hard to detect in the measurements and the current (velocity) is constant during the essential part of the setpoint: the illumination interval. For the sake of convenience, this combination of position-dependent disturbances is called cogging throughout this paper.

The periodicity of the cogging is determined by the spacing between the coils. In our case the spacing between the coils is 20 [mm] which corresponds to a frequency of 50 [1/m] in position domain. With the constant velocity of 0.5 [m/s] in the illumination interval, this means a frequency of 25 [Hz] in time domain. This frequency is expected to be found in the illumination interval of the LFF, as all the deterministic dynamics are learned with ILC. A Power Spectral Density (PSD) of a measured LFF in the illumination interval shows the basic frequency of 25 [Hz] and subharmonics of 75 and 125 [Hz] as can be seen in figure 9.

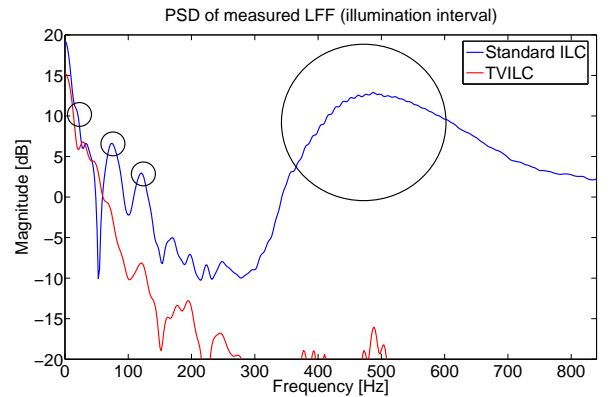

Fig. 9. PSD of learned feedforward signal.

These frequencies can also be found in the PSD of the measured servo error in the illumination interval when acceleration feedforward is applied to the wafer stage. Because acceleration feedforward does not compensate the cogging in the system, the cogging is reflected in the servo error, see figure 10.

Next we shall introduce a mathematical representation for the cogging force, being three harmonics of its Fourier series expansion over the position domain [7], [8], [9], [10]. Let us represent $F_{cog}(x)$ as:

$$F_{cog}(x) = A_1 \sin(\omega x + \phi_1) + A_2 \sin(3\omega x + \phi_2) + A_3 \sin(5\omega x + \phi_3) \quad (2)$$

where A_j represents harmonic's amplitude, ϕ_j the corresponding phase-shift [m], for any $j \in 1, 2, 3$, x the position

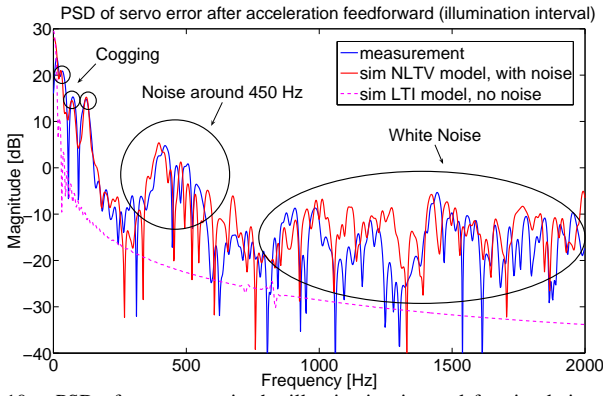

Fig. 10. PSD of servo error in the illumination interval for simulation and measurement.

variable [m], and frequency $\omega = 50$ [1/m]. This position-variable expression $F_{cog}(x)$ can be transformed into a time-variable one $F_{cog}(t)$, by substituting the known setpoint $r(t)$ for the position variable x . In this expression, higher harmonics than 5ω are not taken into account, as these are far less significant visible in figure 9 and 10. With the setpoint known beforehand, the cogging force $F_{cog}(t)$ can be computed and implemented in the system loop as in figure 11.

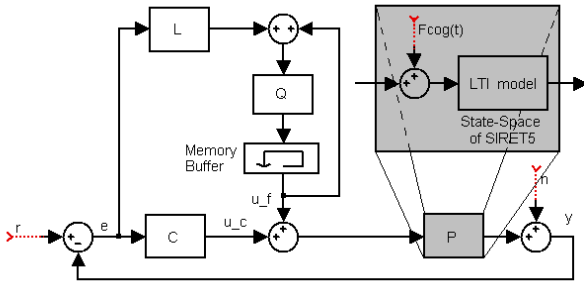

Fig. 11. Updated model.

The parameters of this cogging force are carefully tuned to make a realistic model of the wafer stage. Choosing the basic frequency ω is done by PSD analysis and by reasoning on the basis of geometry. The amplitudes A_1 , A_2 and A_3 are tuned by minimizing the PSD of the difference between the simulation with the model and the measurement, resulting in the PSD's of figure 10. By comparing the servo errors in time domain, the phases ϕ_1 , ϕ_2 and ϕ_3 are tuned, see figure 12.

B. Noise

In this subsection we show that, beside LTI and non-linear deterministic cogging components of the plant model, we have to model and integrate the system noise which is not simply white noise. The measured standstill error of the considered wafer stage gives a good representation of the noise, see figure 13. Obviously band limited white noise is not enough to model the noise of this system, thus an extra source of white noise windowed around 50 and 450 Hz has

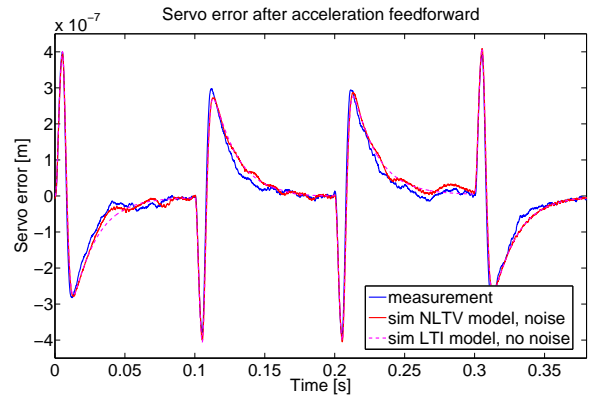

Fig. 12. Servo error of simulations and measurement.

to be added to give a better representation. The parameters of the noise components are tuned by comparing the PSD's of the simulation with the measurement, as can be seen in figure 10. Note that the noise around 50 Hz is caused by interference with the net-current.

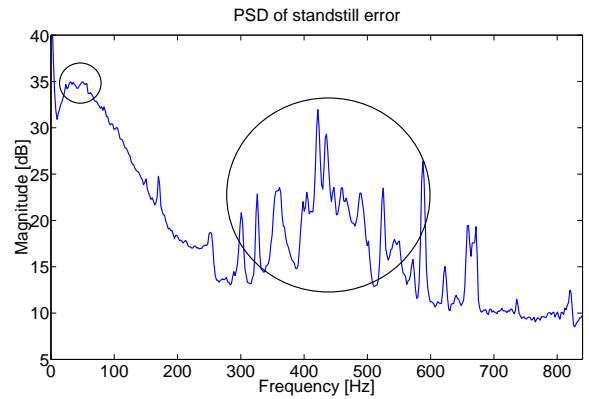

Fig. 13. PSD of the standstill error.

C. Choise of the Q-filter based on the modeling information

In previous research of standard ILC [1], [2], [3], [4] a cut-off frequency of 700 [Hz] is used with the thought that a higher cut-off frequency would result in learning more dynamics. By using this 700 [Hz] cut-off frequency Q -filter in the tuned model of the system, we observe that the simulated servo error is very similar to the measured one, see figure 14.

On one hand this comparison gives a good check for the non-linear-stochastic model of the system, but on the other hand the analysis pictured in the figures 13 and 10 leads us to the conclusion that better tracking performance is obtained when the 700 [Hz] cut-off frequency of the Q -filter is lowered, and this can be explained as follows: (1) As can be seen in figure 13, an extra source of noise is present around 450 [Hz]. Since noise is not deterministic, it cannot be learned and will disturb the learning process. Lowering the cut-off frequency is therefore a better idea on the condition that there are no significant deterministic dynamics present above this cut-off frequency. (2) Simulation of the linear state-space model without noise in figure 10 shows that above 350 [Hz] the

deterministic dynamics have low PSD while the noise becomes dominant. This leads to the conclusion that a cut-off frequency of 350 [Hz] is sufficient to learn the deterministic dynamics and optimal in the sense that it will avoid the extra source of noise around 450 [Hz]. The result is a significant noise reduction in the LFF, see figure 14, but it should be mentioned that this noise reduction is not visible in the servo error.

In this section an accurate model of the motion system with cogging and stochastic noise is obtained and validated according to figure 10 and 12. Now we understand the behavior of the position-dependent dynamics, the LFF can be analyzed in the next section.

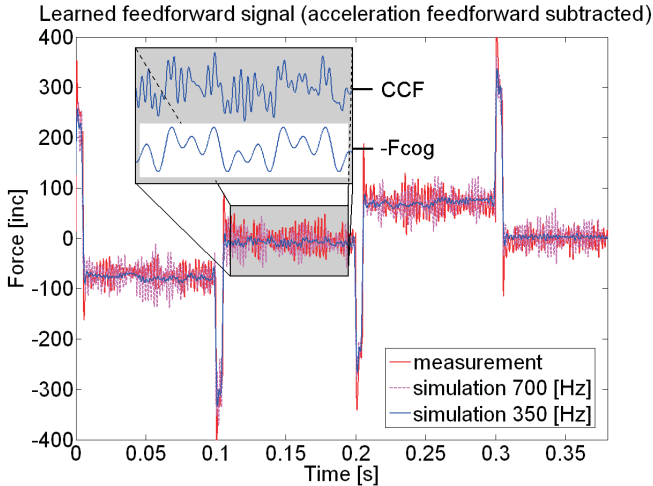

Fig. 14. Learned feedforward signal (LFF) when standard ILC is applied for measurement (cut-off = 700 [Hz]) and simulations (cut-off = 700 and 350 [Hz]).

IV. ANALYSIS OF THE LEARNED FEEDFORWARD SIGNAL (LFF)

A typical LFF when standard ILC is applied is depicted in figure 14. The LFF contains learned deterministic dynamics, i.e. the contribution of the setpoint and of the position-dependent dynamics. There is also a contribution of the noise, which cannot be learned and therefore is useless. It is important to observe that the standard LFF contains more stochastic effects in the illumination interval than the TV LFF in Figure 7. However, it should be mentioned that when applying TVILC for a given setpoint and a given position on the wafer stage, we obtain a comparable tracking performance to the standard ILC applied for the same setpoint and position on stage [3].

The reduced noise of the TV LFF is also visible in the spectral analysis of its CVP depicted in figure 9. The PSD of the same part when standard ILC is applied (figure 9) shows more stochastic effects, but more important also the cogging frequencies. This observation leads to the conclusion that the LFF does not only contain a setpoint compensating force (SCF) and noise as supposed in the PILC after observing TVILC results, but also a cogging compensation force (CCF) as can be seen in standard ILC results. This means that the LFF is built up with the following forces:

- Setpoint Compensation Force (SCF), consisting of acceleration feedforward and higher order dynamics
- Cogging Compensation Force (CCF)
- Noise

In the following we shortly explain the idea of Cogging Compensating Piecewise ILC (CCPILC). Therefore we divide the LFF obtained with standard ILC for a given setpoint situated on a given position on the stage into the CCF and the SCF. The position-dependent CCF can be adapted to other start positions by changing the phase of the signal, because of its periodic nature. Adding the adapted CCF back to SCF will result in a LFF suitable for other start positions.

Next we combine this procedure with the PILC, which is known to solve the dependency of the LFF on the setpoint profile [2], [3]. For this purpose the SCF has to adapt the length of its CVP by inserting or subtracting zeroes, according to the PILC. For CCPILC, the periodic signal representing the CCF has to adapt the length of its CVP by prolonging or shortening the entire CCF signal with periods or with part of. Adding the modified CCF back to the modified SCF will result in a LFF suitable for various start positions and different lengths of the illumination interval. This procedure is explained more in detail in chapter V.

For the CCF identification, it is important to analyze the LFF obtained with standard ILC and not with TVILC. The reason for this is that TVILC minimizes the cut-off frequency of the time-varying robustness Q -filter in order to not amplify noise during the learning process [2], [3], which results in filtering out the cogging frequencies in the CVP, see figure 9. One could remark that TF analysis of the learned servo error will recognize the cogging frequencies such that the Q -filter will allow learning those frequencies, but conventional TF analysis has difficulties to detect the cogging frequencies. The exact reason for this is not in the scope of this paper and we refer for more information to [12].

A. Cogging compensation force

One method to obtain the CCF is by extract it from the CVP of the LFF when standard ILC is applied. During the CVP, no setpoint dynamics are present (SCF = 0) such that the CCF and noise remain, see figure 9 and 14. Given the periodicity of the CCF, one can take several periods of it from the CVP, average those and filter this average above 5ω [Hz] for maximal noise reduction without loss of CCF information, to obtain an accurate CCF period. For the sake of accuracy it is obviously better to take a setpoint with a very long CVP in order to obtain more periods to average. The advantage of this method is that besides the periodicity of 20 [mm] from geometry, no information about the cogging forces in the plant is used to obtain CCF. Note that this operation has only to be performed once to calibrate the system.

A second method to obtain the CCF is by describe this force mathematically with the negative of the given cogging formula (2), where this formula is already validated in chapter III. The ideal CCF is exactly the negative of the cogging force (see figure 14), such that these forces will cancel each other out in the system loop of figure 11, where u_f consists

of SCF + CCF + noise. One way to tune the parameters is to use the modeled system-loop as in chapter III. The problem however, is the difficult tuning of the phases, which results in non-accurate parameters, see figure 12. This is not acceptable for the performance of CCPILC, as a shift in phase is the main cause of larger servo errors as will be explained in chapter V. A better way to tune the parameters of the CCF is by fitting its curve with the CVP of the LFF, after filtering out the noise above 5ω [Hz].

The result of both methods is either a sequence of periods or a mathematical description of the CCF(x) in position domain, which are approximately similar. In this paper we chose the first method for the simple reason of easier implementation. Now the CCF(x) is calibrated, its values can be predicted at every position on the stage and this data can be stored in a database. The CCF(t) in time domain can be obtained by transforming CCF(x) with the given setpoint $r(t)$.

B. Setpoint compensation force

Once the CCF(t) is known, this force can be subtracted from the LFF to retrieve the SCF(t) with an amount of noise. Because the SCF has no compensating force in the CVP, only noise is left in this part of the signal. Therefore all the frequencies can be filtered out of the CVP of the SCF, without losing any deterministic dynamics such that only zeroes remain.

V. CCPILC

The goal of CCPILC is to manipulate a LFF in order to make a feedforward signal suitable for other start positions and illumination lengths than the learned one while still not amplify noise. In the previous chapter the LFF is divided into a setpoint dependent part SCF and a position-dependent part CCF. These forces are divided because changes in start position and setpoint have different consequences for the adaptation of the signals:

- Change start position: change phase CCF. The start position determines the phase of the periodic CCF(x) in position domain.
- Change length illumination interval: change length CVP in CCF and SCF. The length of illumination interval is determined by the CVP of the setpoint, see figure 2. The CCF(x) has to adapt this length by taking a longer or shorter interval in position domain and transform it into time domain CCF(t). The SCF has to adapt this length by adding or subtracting zeroes in the CVP, according to the Piecewise ILC [2], [3].

In other words, a feedforward signal can be created for all lengths of illumination interval and start positions, after splitting one LFF in four different components: The SCF of the LFF can be divided into an ACP, CVP and DCP, where the CVP is adaptable in length according to the PILC. The CCF(t) will be created using the information of the setpoint and the start position, to obtain the matching interval from the CCF(x) database. This CCPILC concept is depicted in figure 16 where the signals are in time domain.

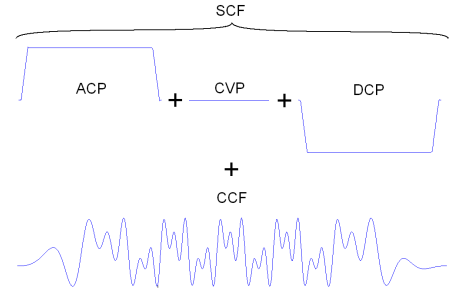

Fig. 15. Concept of the CCPILC.

The effect of CCPILC on the CCF(x) is schematically depicted in figure 16. The cogging force is represented as a sine function, and the signals are in position domain. For a given cogging force, standard ILC learns a CCF(x) which will cancel out the cogging force exactly, as shown in the first row. The third row shows the case when the length of the illumination interval is prolonged with 10 [mm], according to the first experiment in the introduction. CCPILC takes this into account by creating a new CCF for the entire setpoint resulting in zero cogging disturbance. The last row shows the case when the start position is shifted with 10 [mm], according to the second experiment in the introduction. Since the period of the cogging is 20 [mm], the cogging force has shifted in phase by 180 degrees comparing to the original situation. CCPILC takes this into account and obtains a CCF that will cancel out the cogging force exactly.

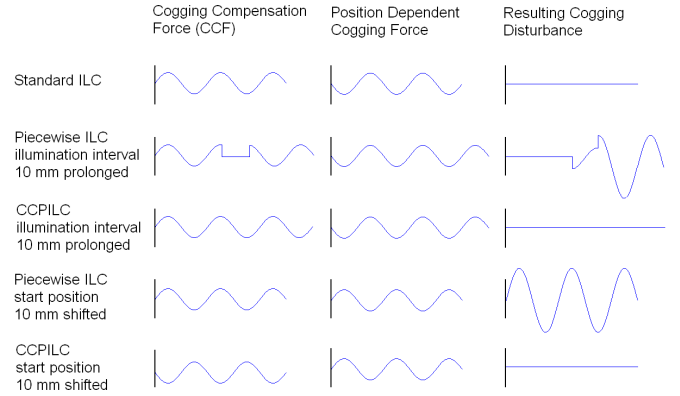

Fig. 16. Schematic view of the effect of Standard ILC, Piecewise ILC and Cogging Compensating Piecewise ILC on the CCF and the resulting cogging disturbance.

Figure 16 also explains schematically why the PILC does not achieve optimal performance for the experiments performed in [2], which results are shown in the introduction. In the first experiment the length of the illumination interval is prolonged with 10 [mm], depicted in the second row. From the position where the CVP is prolonged, a larger cogging disturbance occurs, caused by the added zeroes without cogging compensation. This cogging disturbance becomes larger after the added zeroes, where the CCF is in "anti"-phase with the cogging force resulting in maximal cogging disturbance, see figure 3. In the second experiment

where the start position is shifted with 10 [mm], a maximal "mismatch" in phase occurs during the entire setpoint, depicted in the fourth row. The result is a maximal cogging disturbance causing a larger servo error during the entire interval, see figure 4. Obviously, the "mismatch" in phase is directly related to the start position and the periodic cogging disturbance. This mismatch is translated into a larger servo error in figure 5 and explains the periodicity of 20 [mm] which is exactly the periodicity of the cogging disturbance.

VI. RESULTS, COMPARISONS AND INTERPRETATIONS

The experiments performed on the actual SIRE T5 (see introduction) are reconstructed with the tuned model to check the performance of the model and CCPILC:

- the length of illumination interval is prolonged with 10 [mm]
- the start position is shifted with 10 [mm]

These experiments are performed with standard ILC, PILC and CCPILC, as can be seen in the following figures.

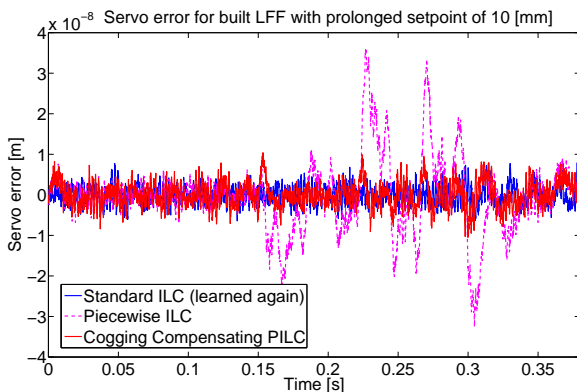

Fig. 17. Effect on servo error after prolonging the illumination interval with 10 [mm], with CCPILC, PILC and Standard ILC.

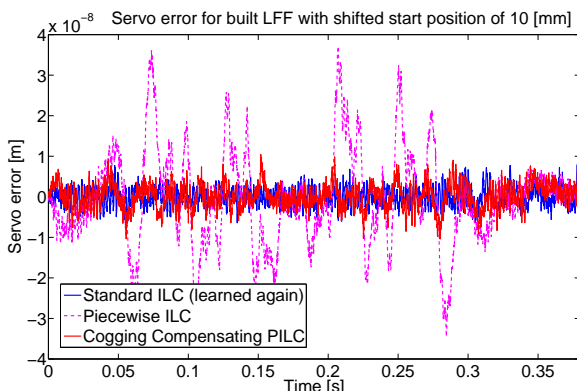

Fig. 18. Effect on servo error after shifting the start position with 10 [mm], with CCPILC, PILC and Standard ILC.

Comparing these simulated results with the measured data of figures 3 and 4 leads to the conclusion that the used model is a very good approximation of the real system. This is visible in the similar results in shape and magnitude of the PILC and the standard ILC.

Another conclusion is that the CCPILC does lead to a large improvement comparing to the PILC. As expected, its performance is comparable to that of standard ILC, although small traces of the cogging force are present in the servo error. A small oscillating mismatch in force ($F_{cog}(t) + CCF(t)$) will be present during the entire setpoint and causes at the beginning of the acceleration and at the end of the deceleration a maximum servo error. At these positions the velocity is lowest, such that a mismatch in force holds for a longer time period resulting in a larger error in position. In the most essential part of the setpoint, the CVP, the servo error is reduced to a maximum of 10 [nm]. This is an improvement of a factor 4 with PILC and a factor 40 comparing to the servo error after acceleration feedforward of 400 [nm], see figure 12.

VII. CONCLUSIONS

The tuned time varying non-linear model of the SIRET5 is accurate in the sense that the same inputs does lead to the same outputs as the measurements of the real system. This can be seen in figures 10 and 12, but also by comparing figures 3 and 4 with 17 and 18 respectively.

Lowering the cut-off frequency of the robustness Q -filter from 700 to 350 [Hz] shows a significant reduction in noise in the learned feedforward signal.

The Cogging Compensating Piecewise Iterative Learning Control (CCPILC) is applied to this model and shows a significant improvement with respect to the Piecewise ILC (see figure 17 and 18). The performance is comparable to standard ILC with the main advantage that the iterative learning procedure has to be performed only once for different start positions and lengths of illumination interval. This solves the main problems of ILC applied to a wafer stage [4]:

- *Standard ILC has limited performance in the face of position dependent dynamics.*
- *Standard ILC does not account for setpoint trajectory changes.*

The CCPILC is easy to implement because no extra information is needed besides the periodicity of the cogging force i.e. the distance between the coils of the permanent magnetic linear motor (PMLM).

Although the CCPILC leads to the desired performance on an accurate model, experiments on the real system have to confirm this.

REFERENCES

- [1] I. Rotariu, G. van Baars, and F. Sperling, "Iterative learning control applied to the sire-t5 short stroke test rig," 2002.
- [2] I. Rotariu, R. Ellenbroek, and M. Steinbuch, "Adaptive iterative learning control with application to a wafer stage," *to appear in IEEE Transactions on Control Systems Technology*.
- [3] I. Rotariu, R. Ellenbroek, G. Baars, and M. Steinbuch, "Iterative learning control for variable setpoints, applied to a motion system," *European Control Conference, University of Cambridge, UK, 2003*.
- [4] I. Rotariu, R. Ellenbroek, and M. Steinbuch, "Time-frequency analysis of a motion system with learning control," Philips CFT (NL).
- [5] I. Rotariu and E. Vullings, "Matching pursuit algorithm applied to an adaptive learning control system," 2005.
- [6] —, "Multi-dictionary matching pursuit for a servo error analysis applied to iterative learning control," 2005.

- [7] N. Bianchi, S. Bolognani, and A. Cappello, "Reduction of cogging force in pm linear motors by pole-shifting," in *IEE Proc.-Electr. Power Appl.*, vol. 152, no. 3, May 2005.
- [8] Z. Zhu, Z. Xia, D. Howe, and P. Mellor, "Reduction of cogging force in slotless linear permanent magnet motors," vol. 144, no. 4, July 1997, pp. 396–401.
- [9] R. Brydon, O. Maggiore, and M. Maggiore, "Implementation and model verification of a magnetic levitation system," *ACC Conference, Portland, OR, USA*, June 8–10 2005.
- [10] H. Ahn, Y. Chen, and H. Dou, "State-periodic adaptive compensation for cogging and coulomb friction in permanent-magnet linear motors," vol. 41, no. 1, January 2005.
- [11] T. de Vries, W. Velthuis, and L. Idema, "Application of parsimonious learning feedforward control to mechatronic systems," vol. 148, no. 4, July 2001.
- [12] B. Hennen, I. Rotariu, and M. Steinbuch, "Time-frequency analysis of position-dependent dynamics in an iteratively controlled waferstage," *b.a.hennen@student.tue.nl*, 2006.