

MASTER

Evaluation of data-centric process modeling approaches

Diaz Garcia, H.D.

*Award date:*  
2011

[Link to publication](#)

**Disclaimer**

This document contains a student thesis (bachelor's or master's), as authored by a student at Eindhoven University of Technology. Student theses are made available in the TU/e repository upon obtaining the required degree. The grade received is not published on the document as presented in the repository. The required complexity or quality of research of student theses may vary by program, and the required minimum study period may vary in duration.

**General rights**

Copyright and moral rights for the publications made accessible in the public portal are retained by the authors and/or other copyright owners and it is a condition of accessing publications that users recognise and abide by the legal requirements associated with these rights.

- Users may download and print one copy of any publication from the public portal for the purpose of private study or research.
- You may not further distribute the material or use it for any profit-making activity or commercial gain

**Take down policy**

If you believe that this document breaches copyright please contact us providing details, and we will remove access to the work immediately and investigate your claim.

# **Evaluation of Data-Centric Process Modeling Approaches**

Hector Daniel Diaz Garcia  
August 2011



# **Evaluation of Data-Centric Process Modeling Approaches**

*Master Thesis*  
**Business Information Systems**

Hector Daniel Diaz Garcia

Supervisors:

dr. ir. Hajo Reijers

dr. ir. Pieter van Gorp

Dr. Dirk Fahland

**Eindhoven, August 2011**



# Acknowledgements

*My master studies and this project are dedicated to my wife, Karla, for her infinite love and patience. This is the pinnacle of a dream that would have not been possible without her in my life.*

*All of this would have not been possible either without the care, support and love of my family. Esperanza, Raul, Daniela y Ana: this master is your master.*

*I want to thank dr. ir. Hajo Reijers for his priceless support and orientation and for being a role model to me. Thanks also to dr. ir. Pieter van Gorp for his helpful feedback and for trusting me as his assistant. Thanks to dr.ir. Irene Vanderfeesten for her valuable feedback and enthusiasm in this mission. I want to thank Dr. Dirk Fahland as well for his interest in my project.*

*Special thanks to the students and modeling practitioners that participated in the evaluation phase.*

*Thanks to all of my friends in Eindhoven. These two years were one of the most enriching and amazing experiences of my life and all of that because of you. Special thanks to Manuel and Santiago, my loyal friends and teammates. Alejandro, Andres, Armando, Cesar, Ezequiel, Guyon, Juanes and Rafael: thank you.*



## TABLE OF CONTENTS

<b>1</b>	<b>Introduction</b> .....	1
1.1	Research Questions.....	3
1.2	Research Approach .....	4
1.3	Previous Works .....	6
1.4	Document Structure .....	7
<b>2</b>	<b>Business Process Management</b> .....	8
2.1	Business Process Management Definition .....	8
2.2	Business Process Management Lifecycle .....	9
2.3	Business Process Modeling .....	11
2.3.1	Process Modeling Elements .....	12
2.3.2	Process Modeling Perspectives.....	13
2.3.2.1	Activity-Centric Process Modeling .....	14
2.3.2.2	Other process modeling perspectives.....	16
2.3.3	Process Modeling Techniques.....	18
2.4	Techniques for Evaluation of Business Process Modeling Methods .....	19
2.4.1	Selection of Evaluation Techniques.....	21
<b>3</b>	<b>Non-Empirical Evaluation of Data-Centric Modeling Approaches</b> .....	22
3.1	Methodology.....	22
3.2	Selection of Methods.....	22
3.3	Review of Modeling Approaches.....	24
3.3.1	Bridging Methods.....	24
3.3.1.1	Bridging Object-Oriented Modeling and Process Modeling Domains .....	25
3.3.1.2	TriGSflow.....	27
3.3.1.3	WASA <sub>2</sub> .....	28
3.3.2	Object Lifecycle-Based Process Models.....	28
3.3.2.1	Object-Centric Process Models .....	28
3.3.2.2	Object Lifecycle-Compliant Process Models.....	30
3.3.2.3	Artifact-Centric Process Models .....	31



3.3.2.4	Data-Driven Modeling and Coordination of Process Structures.....	34
3.3.3	Data-Driven Execution Methods .....	36
3.3.3.1	Product-Based Workflow Design .....	36
3.3.3.2	Case Handling .....	39
3.3.3.3	Document-Driven Workflows .....	40
3.4	Selection of Features .....	41
3.5	Evaluation Framework.....	42
<b>4</b>	<b>Empirical Evaluation of Data-Centric Modeling Approaches .....</b>	<b>47</b>
4.1	Evaluation of User Perceptions .....	47
4.1.2	Method Evaluation Model .....	48
4.1.3	Selection of Data-Centric Approaches.....	49
4.1.4	Construction of Models .....	50
4.1.4.1	Case Selection .....	51
4.1.4.2	Presentation of the content.....	51
4.1.4.3	Focus Groups .....	53
4.1.5	Questionnaire Design .....	53
4.1.6	Data Collection Protocol .....	54
4.1.7	Results and Findings .....	55
4.1.8	Limitations .....	58
4.2	Practitioners' Case Studies .....	59
<b>5</b>	<b>Conclusions.....</b>	<b>62</b>
	<b>References.....</b>	<b>64</b>
	<b>Appendix A. Reference Conceptual Map .....</b>	<b>73</b>
	<b>Appendix B. Methods Selection.....</b>	<b>74</b>
	<b>Appendix C. Methods Drives and Motivations.....</b>	<b>76</b>
	<b>Appendix D. Case Description .....</b>	<b>78</b>
	<b>Appendix E. Product-Based Workflow Design Models.....</b>	<b>80</b>
	<b>Appendix F. Data-Driven Process Structures Models.....</b>	<b>84</b>
	<b>Appendix G. Artifact-Centric Business Process Models .....</b>	<b>87</b>
	<b>Appendix H. Data-Centric Modeling Approaches Survey .....</b>	<b>95</b>

## LIST OF FIGURES

Figure 1.1 Research Approach .....	4
Figure 2.1 BPM Lifecycle by Weske .....	10
Figure 2.2 Modeling hierarchical decomposition .....	12
Figure 2.3 Process modeling perspectives .....	17
Figure 2.4 MOF Levels of process aspect .....	18
Figure 2.5 Perspectives for Empirical Evaluation of Process Modeling Techniques ....	20
Figure 3.1 Non-empirical evaluation methodology .....	22
Figure 3.2 Illustration of MERODE basic constructs .....	26
Figure 3.3 Metamodel for conceptual modeling .....	27
Figure 3.4 Transformation of object-behavior to activity-centric model .....	30
Figure 3.5 Creation of data-driven process structures .....	35
Figure 3.6 Product-data model example .....	37
Figure 3.7 Classification of Data-Centric Process Modeling Approaches.....	43
Figure 4.1 Approach for the evaluation of user perceptions .....	47
Figure 4.2 Method Evaluation Model.....	49
Figure 4.3 Population statistics .....	55
Figure 4.4 Perceived Ease of Use and Perceived Usefulness of modeling approaches	56
Figure 4.5 Perceived Ease of Use and Perceived Usefulness per groups of participants .....	57
Figure 4.6 Perceived Ease of Use and Perceived Usefulness of participants without previous knowledge.....	58
Figure A.1 Business Process Modeling Reference Conceptual Map .....	73
Figure E.1 Product-data model .....	83
Figure F.1 Custom bikes data model .....	84
Figure F.2 Lifecycle Coordination Model .....	86
Figure G.1 Business artifacts for the custom bikes case .....	87
Figure G.2 Business artifacts lifecycles.....	89

## LIST OF TABLES

Table 2.1 Process Modeling Objectives .....	11
Table 2.2 Process Modeling Perspectives .....	13
Table 2.3 Limitations of the activity-centric modeling perspective .....	15
Table 2.4 Process Modeling Evaluation Techniques.....	20
Table 3.1 Selected Methods.....	23
Table 3.2 Benefits of integration of object-oriented and workflow modeling.....	24
Table 3.3 Benefits of artifact-centric process modeling .....	32
Table 3.4 Production rules for example of product-data model [9] .....	38

Table 3.5 Differences between workflow management and case handling [37] .....	39
Table 3.6 Evaluation of data-centric approaches by flexibility type .....	46
Table 4.1 Selection of Modeling Notations .....	52
Table 4.2 Items per theory construct .....	54
Table 4.3 Constructs reliabilities .....	56
Table 4.4 Real usage scenarios .....	60
Table 4.5 Drivers in practical applications .....	61
Table B.1 Citations Count .....	75
Table C.1 Methods drives and motivators .....	77
Table E.1 Data Elements .....	80
Table E.2 Production rules .....	82

## 1 Introduction

The evolving importance of Business Process Management (BPM) over the last years can be proven by the increasing amount of academic and industrial research in the field, the number of BPM initiatives in all kinds of companies as well as the emergence of multiple BPM systems vendors. BPM current status is rooted in the process reengineering [1] and processes innovation [2] approaches of the nineties into a wider scope area aiming to improve operational performance using methods, metrics and software tools that allow the definition, design, enactment, monitoring and improvement of business processes.

BPM is based on the notion of a business process, “a set of logically related tasks performed to achieve a defined business outcome” [3]. According to Ould, three waves in business processes can be distinguished over the last decades [4]. In the first wave, processes were custom and modeled in terms of diagrams with simple sequential processes generally stored inside procedure manuals. In the second wave, processes were subordinated to ‘information’ by restraining business processes to the allowed information flows in the information systems; this wave is characterized by generic software with embedded workflow functionality like Enterprise Resource Planning (ERP) systems. Finally, in the third wave, the information dominance paradigm is replaced by the business process figure which determines what information will be kept: “process first, then information” [4].

Traditional approaches to business process and workflow modeling are based on this process-centric perspective in the sense that they are designed to specify the activities that need to be executed to achieve a certain goal, emphasizing the relationships between those activities, the workflow patterns and control of tasks, providing limited attention to data which is incorporated in posterior phases of the modeling process and mainly focused on the inputs and outputs of individual services [5]. Despite its wide acceptance, some limitations of this perspective are that workflows tend to be not understandable when processes grow in size and complexity [6], response times to process changes are high and the moving of contextual information to the background derives in errors and inefficiencies [7]. Such drawbacks have promoted the appearance of alternate approaches.

Nevertheless, a revival of the data perspective in process modeling has arisen over the last years as observed in the appearance of several data-oriented approaches to workflow and process modeling from industry and academia. These approaches intend to reconcile process and data by introducing data as the central entity that drives the

process modeling. Traditional approaches can be considered as verb-centric, while the new approach is noun-centric in the sense that first are identified the data and objects that are important to business and then, how these things are processed to achieve a certain goal [8]. This renewed data orientation in design and redesign of processes can also be found in the introduction of systems that accentuate the information being handled in business processes (e.g. case management systems).

Several approaches based on the data-centric workflow modeling paradigm have been proposed by academic and industry research institutions and they have also been tested in practice in several practical engagements and research scenarios (e.g. [9], [10]). Some work has been done to highlight the relations between the activity-centric and data-centric approaches [6], but there is little work focusing on the comparison of the different independent works on the latter perspective. A more profound analysis is needed on the data-centric modeling approaches since many methods with their own characteristics have appeared and it makes sense to understand their nature, commonalities and differences.

The aim of this master thesis is to provide knowledge and to give insights of the relative strengths and areas for improvement of the data-centric modeling approaches as well as of their differences and similarities, from both a theoretical and empirical perspective. The theoretical analysis consists of the study of literature on the topic aiming for the construction of a framework that allows characterizing the different approaches and gives insights on ways to enhance, improve and complement the current methods; this analysis represents a contribution of the foundational knowledge of this BPM research direction. Furthermore, the intention of the research is to study the empirical implications of the different methods in two directions. First, studying the benefits obtained from practice descriptions and, secondly, from a modeler's evaluation of the application of a set of selected methods on a common case.

## 1.1 Research Questions

The objective of this master thesis is to understand and compare the different data-centric business process and workflow modeling approaches. It aims to answer the following questions:

- 1) *What are the common and distinctive features of the various data-centric process modeling approaches?*
- 2) *What are the modelers' attitudes towards the application of the data-centric modeling approaches?*
- 3) *What are the contexts, advantages and disadvantages of the use of the distinct data-centric approaches in practice?*

These questions originate from the emergence of several independent approaches for the integration of process and data in process and workflow modeling and the objective is to answer these questions on a set of selected approaches. The first question corresponds to a theoretical study based on literature that aims to identify the distinctive features of each method since learning from their individual characteristics and advantages can help 1) to classify them, 2) to move towards more robust approaches and 3) to support the decision of selecting the most appropriate method according to the modeling objectives and context [11]. Furthermore, an analysis of the drives and intended benefits from which these methods were developed is made.

In information systems research, a general emphasis is given to the development of new system development methodologies and frameworks for their comparison, but their actual use or evaluation in practice is limited [12]. The second and third research questions aim to address this gap.

The second research question corresponds to the evaluation of the attitudes of process modelers with respect to the use of the methods. The focus of the assessment is on the Perceived Usefulness and Perceived Ease of Use as considered in the Method Evaluation Model [13], a variant of the Technology Acceptance Model [14].

The third research question intends to understand the benefits, improvements and disadvantages of the application of the selected set of data-centric approaches in practice, as well as the contexts and domains where they have been used. This knowledge is important since the validity of the methods can be established by their success in practice and may be valuable when determining the suitability of a method for a given situation.

Both theoretical and empirical perspectives provide a holistic approach by combining methods that contribute with richer outcomes to the body of knowledge of this research direction.

## 1.2 Research Approach

The research methodology consists of four major phases. Figure 1.1 indicates the document section where each phase is addressed.

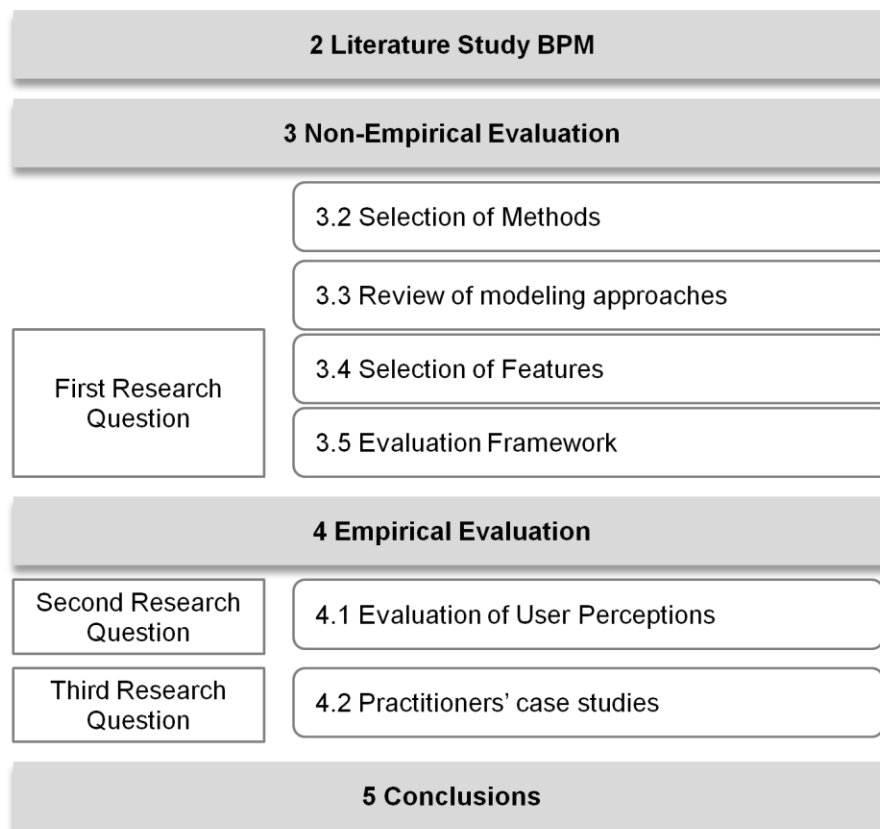

Figure 1.1 Research Approach

### ***Phase 1: Literature Study of BPM***

As preparatory phase of the research, a literature study is made to establish definitions for the key concepts in the Business Process Management discipline emphasizing the different process modeling perspectives.

## ***Phase 2: Theoretical Evaluation***

The second phase consists of a literature study and survey of the existing data-centric approaches. It provides theoretical foundations of each method as preliminary analysis to answer the three research questions. The different approaches are evaluated based on a feature comparison technique. Based on the collected literature, a set of key common and distinctive features is detected and used to build the comparison framework.

Although data-centric process modeling is a relatively novel approach, many publications and work related with the topic have been published by several academia and industry institutions and it is necessary to establish a methodological search strategy to secure the quality and relevance of the gathered material.

A data collection protocol is defined to secure the quality and relevance of the studied material; journal papers and conferences are selected as primary source of data and they are complemented with information and referrals provided by relevant actors in the domain.

Following the work by Bandara [15], three main criteria are defined for the bibliography search method: the domain (the field of knowledge where the research is conducted), the sources (databases and other resources where the information is obtained) and the search strategy (the set of search terms used during the collection strategy).

- The domains were selected going from the broad to the particular: Information Systems and Business Process Management. Information Systems correspond to the broader research domain that covers the design, analysis, support and improvement of information and communication technologies supporting organizational processes. Business Process Management is the systematic approach for the analysis, management, control and improvement of business processes in organizations.
- Journals and conferences are selected as the primary source of information for the selected domains. For assessing the relevance of publications, the citations count provided by search engines, e.g. Google Scholar, is used as criterion; in general a publication with a larger citation count is privileged over another with less citations.
- Finally, the search terms for the retrieval of documents are defined. For the specific case of searching data-centric process modeling approaches, the terms *business process modeling approaches*, *business process modeling paradigms* and *business process modeling methods* were used. After that a refinement was



made using selected keywords including: *information centric process*, *data centric process*, *data driven process*, *artifact centric process*, *product based process*, *document driven process* and *object centric process*. The same keywords were used interchanging the word *process* for *workflow*. Additionally, some other approaches cited in already extracted articles and direct referrals from researchers in the domain have been considered.

### **Phase 3: Empirical Evaluation**

The last phase of the research evaluates the practical implications of modeling business processes using the different approaches. The first empirical evaluation consists of the evaluation of the data-centric methods from a modeler's perspective. A questionnaire is used to evaluate the Perceived Usefulness and Perceived Ease of Use of the methods; the findings are valuable since the adoption and intention of use of modeling approaches is related with both dimensions. Practitioners and students are the target groups of the evaluation.

The second empirical evaluation consists of the study of the reported experiences of practitioners when using particular data-centric approaches in real scenarios. These practice descriptions provide a way of verifying the advantages and disadvantages of each method in certain contexts and serve as an additional source of data for empirical evaluation, useful as auxiliary tool for the assessment and selection of approaches.

### **Phase 4: Conclusions**

Finally, a global analysis is made from both theoretical and empirical phases to derive conclusions. Findings and future research opportunities are described.

## **1.3 Previous Works**

Most of the recent research emphasizes the exploration of the data-centric approaches from an individual perspective, i.e. they analyze the different possibilities of a particular approach with respect to its supporting methods, techniques and tools. For instance, from the methods perspective, a data-centric design methodology for business processes has been proposed for the artifact-centric modeling initiative [5]. Regarding languages, Product-based Workflow Design (PBWD) workflows may be represented by YAWL or Petri net techniques [9]; artifact-centric models have been represented using both procedural and declarative metamodels [5]. From the tools perspective, PBWD has

been tested and compared in FLOWer and Activity Manager systems [16]; the artifact-centric approach has been implemented in the IBM's FastPath tool and Siena prototype; and data-driven process structures are supported in the COREPRO modeler [17].

On the other hand, there is a limited amount of studies dedicated to the comparison of the different data-centric approaches. Künzle & Reichert [18] determined from literature the main characteristics needed for their object-aware processes and made a feature comparison of several approaches. Henriques & Silva [19] analyzed the support of data-related requirements like access and granularity for a number of object-oriented approaches. Regarding the theoretical evaluation, the present work extends these studies in two aspects: first, it evaluates a different set of methods e.g. it includes methods linking object-oriented and process modeling domains and, second, the evaluation is made across the drives behind the development of the methods, e.g. increased flexibility, process optimization, etc. Furthermore, the present study provides an empirical evaluation of the Perceived Usefulness and Perceived Ease of Use of a set of methods.

## 1.4 Document Structure

The remaining document is structured as follows:

- **Chapter 2 Business Process Management** introduces the Business Process Management discipline and defines its main concepts and terms.
- **Chapter 3 Data-Centric Modeling Approaches** documents the characteristics of a selected number of methods and provides the theoretical evaluation.
- **Chapter 4 Empirical Evaluation** describes the characteristics of the empirical evaluation of a selected number of methods and the results obtained.
- **Chapter 5 Conclusions** concludes the study and provides directions for future research.

## **2 Business Process Management**

This chapter provides an overview of the basic concepts and definitions used in Business Process Management with the purpose of establishing a consistent terminology and putting the research objects in context. Scientific literature is retrieved using the literature collection protocol and complemented with books specialized in the BPM topic. Section 2.1 gives definitions for business process, workflow and business process management. Section 2.2 describes the BPM lifecycle. Section 2.3 treats business process modeling elements and the limitations of the traditional activity-centric modeling approach. Section 2.4 explores the different techniques for evaluation of process modeling methods.

### **2.1 Business Process Management Definition**

Business Process Management (BPM) has emerged as an area of evolving significance in industry and research by providing ways for the achievement of operational efficiency in times when resource optimization and performance improvement are regular challenges for organizations. Factors driving organizations to engage in BPM initiatives include the formalization of existing processes, detection of needed improvements, facilitation of efficient process flows, increase of productivity, analysis of complex problems and regulations compliance [20].

According to Hammer [21], BPM has two primary intellectual antecedents. The first one is the modern quality movement that relies on statistics and metrics for measuring work in order to detect and address performance problems; this movement is characterized by approaches like the Total Quality Management focus of the eighties. The second antecedent corresponds to the Business Process Reengineering wave of the nineties as promoted by Hammer & Champy, which propose the fundamental rethinking and radical redesign of business processes to achieve sustained improvements. The fusion of these two approaches along with other influences such as Davenport's work on business process innovation [2] are the roots of modern BPM.

Business processes are the cornerstone of BPM. Many definitions have been proposed [1,4,22], but they all share the notions of people or entities executing activities where inputs are transformed into valuable outputs. The following are typical definitions for the term business process:

- Hammer defines a business process as “a collection of activities that takes one or more kinds of input and creates an output that is of value for the customer” [1].
- Ould defines a business process as “a coherent set of activities carried out by a collaborating group to achieve a goal”; they are fundamental building blocks of the organization and they are what the organization is about [4].
- a more detailed specification is given by the Workflow Management Coalition (WfMC) which defines it as “a set of one or more linked procedures or activities which collectively realize a business objective or policy goal, normally within the context of an organizational structure defining functional roles and relationships” [22].

Business processes may be enacted with support of information systems. Automation of business processes by information systems is made through a workflow, defined by the WfMC as “*the automation of a business process, in whole or part, during which documents, information or tasks are passed from one participant to another for action, according to a set of procedural rules*” [22].

The practice of BPM is related with activities that go beyond the only enactment of business processes: it also covers their control, monitoring, analysis and continuous improvement. Based on these notions, BPM can be defined as:

- “...concepts, methods and techniques to support the design, administration, configuration, enactment and analysis of business processes” [23].
- “a structured, coherent and consistent way of understanding, documenting, modeling, analyzing, simulating, executing and continuously changing end-to-end business processes and all involved resources in light of their contribution to business performance” [24].

The previous and following concepts treated in this chapter are provided in Appendix A as a Reference Conceptual Map. This type of map provides a big picture of the main related concepts in an easy-to-observe way and with their respective references [25].

## 2.2 Business Process Management Lifecycle

The previous definition of BPM implies an end-to-end approach to business processes in which several stages can be identified and whose logical dependencies form the BPM lifecycle. Figure 2.1 represents the BPM lifecycle according to Weske [23]; it includes design & analysis, configuration, enactment and evaluation of business processes with an emphasis on their Administration and Stakeholders. Other variants of the BPM lifecycle have been proposed by many authors, but in general they all reveal a cyclic nature and highlight the continuous improvement of business processes.

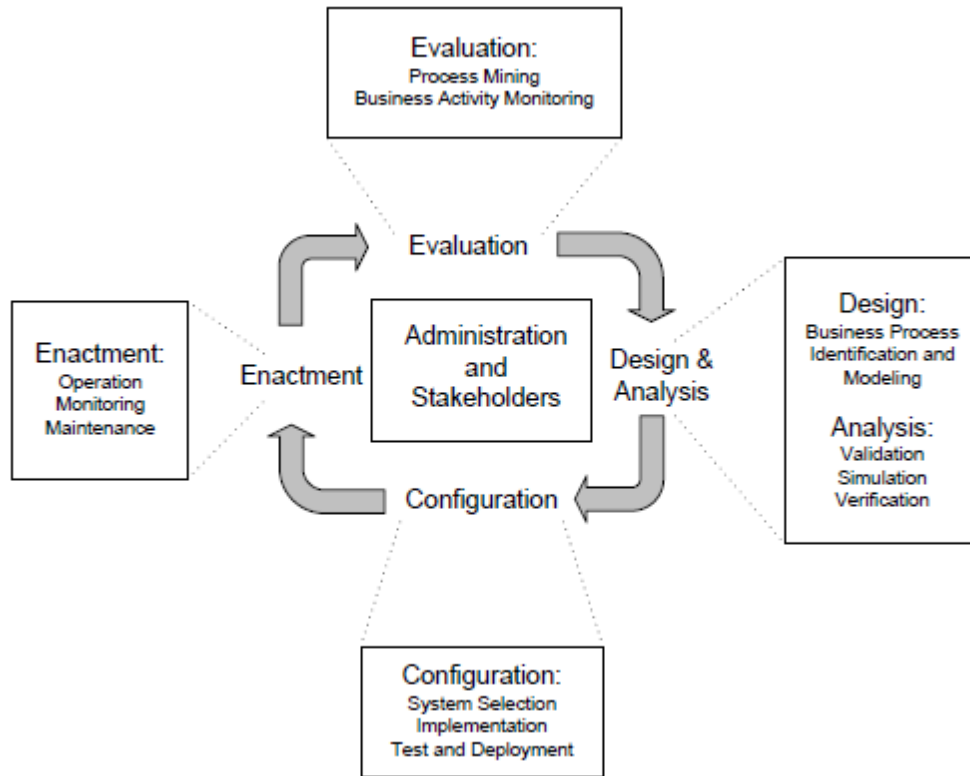

Figure 2.1 BPM Lifecycle by Weske [23]

BPM lifecycle is entered in the Design & Analysis phase, in which surveys and other instruments are used for the identification and later representation of processes via business process models. Modeling is the core sub-phase during the design stage [23]. These designs are validated with different stakeholders in the organization and simulation techniques can be used to support the validation. Also, verification techniques may be applied to check consistency and correctness of the designs.

In the configuration phase, business processes are implemented. This implementation may be supported by a Business Process Management System (BPMS), “a software system that is driven by explicit process designs to enact and manage operational business processes” [26]. The system needs to be selected, configured, tested and deployed. Additionally, business processes may be realized without these systems by implementing them as a set of procedures or policies that organization actors need to comply with [23].

The enactment consists in the actual execution of the business process by the actors of the organization. The execution of the process instances is controlled by the BPMS; the status of each instance is monitored and can be made available to stakeholders by the use of visualization techniques.

The evaluation phase provides information for the improvement of the business processes. For example, business process execution logs can be analyzed with process mining tools for the discovery, conformance, organizational analysis and performance analysis of business processes. Business Activity Monitoring tools use logged data to analyze operational processes and detect bottlenecks, flow times, etc. The information obtained from these techniques may result in the identification of issues and subsequent business process redesign initiatives.

## 2.3 Business Process Modeling

The BPM lifecycle exposes the importance of process modeling: it is only after the process has been designed and modeled that the other phases of the lifecycle can be enabled. Process modeling is a fundamental activity for organizations trying to engage in BPM initiatives since models can be used to communicate the current state of processes (as is) as well as the possible future scenarios (to be); models can also be used for the design of systems supporting the enactment of those processes. Before coming to a definition of business process model, it is important to consider that a model is a set of statements about some system under study [27], and the details captured in them are aligned with the objectives for what they are constructed and the use that they will be given. Curtis et al. [28] and Krogstie et al. [29] distinguish five main categories of objectives and correspondent uses of process modeling (cf. Table 2.1). Identification of the modeling purposes and uses is important since some modeling approaches may be more suitable for one specific purpose than others [30].

<b>Modeling objectives</b>	<b>Description</b>
Facilitate human understanding and communication	Human sense making and communication of aspects of an enterprise; support of the communication among different stakeholders.
Support process improvement	Basis for defining and analyzing a process; computer-assisted analysis to gain knowledge through simulation or deduction; detection of flow times, bottlenecks.
Support process management	For the adherence of work process to standards and regulations; models exist as reference point over time.
Automate execution support	Deployment and activation of the model with support of information systems for controlling behavior in an automated environment.
Automate process guidance	Automate tools for manipulating process descriptions; using the model as a context for a system development project without implementing it

Table 2.1 Process Modeling Objectives (adapted from [28], [29])

Business process modeling is the act of representing a process through a model. A process model:

- “describes, typically in a graphical way, the activities, events and control flow logic that constitutes a business process” [31];
- “consists of a set of activities and execution constraints between them” [23].

It is noticeable that these definitions of business process model emphasize the control flow perspective, typical of the traditional approaches of business process modeling.

### 2.3.1 Process Modeling Elements

Giaglis [32] proposes a hierarchical decomposition of business process and information systems modeling based on three elements: methodologies, techniques and tools (cf. Figure 2.2). According to this decomposition, modeling is supported by a number of *methodologies* which make use of several *techniques* supported by a number of *tools*.

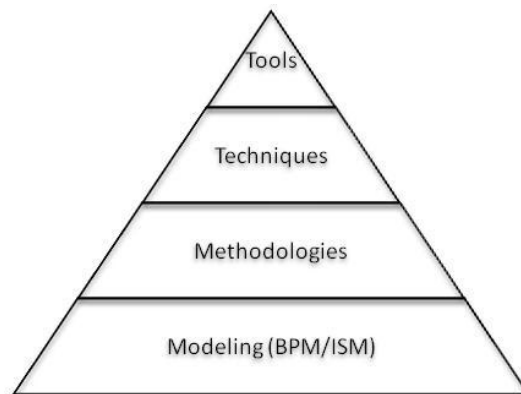

Figure 2.2 Modeling hierarchical decomposition [32]

*Methodology*, as considered by Giaglis, is used to refer to the modeling paradigm. A more precise definition given by Kettinger et al. [33] considers methodology as “a collection of problem-solving methods governed by a set of principles and a common philosophy for solving targeted problems”. A method is “an approach to perform a system development project, based on a specific way of thinking, consisting of directions and rules, structured in a systematic way...” [11]. Methods are supported by a set of guidelines, techniques and tools that drive the process of modeling.

Techniques, also named languages [15], refer to the diagrammatic or other notations used for representing, studying and analyzing business processes [32]. Examples of languages are Petri nets, Business Process Modeling Notation (BPMN), Event-driven Process Chain (EPC), UML activity diagrams, etc.

Tools refer to the software pieces or applications that support the modeling techniques and that facilitate the design, maintenance and distribution of process models [15]. Some well known vendors of BPM suites include IBM, Pallas Athena, Tibco, Oracle and MetaStorm among others. Tools may be compared in terms of e.g. simulation capabilities and cost of ownership.

These three elements are fundamental for the success of process modeling. A recent study by Basana [15] suggests factors that determine the success of modeling initiatives and their correspondent measures; factors are classified in modeling specific factors and context specific factors. The first refer to those factors intrinsic to the modeling activity, namely, the modeling method, the modeling language and the modeling tool (analogous to the hierarchical decomposition shown in Figure 2.1); the latter refer to those factors such as the modeler’s expertise, project management, user competence, etc., which are more related to the human aspect of the modeling activity.

### 2.3.2 Process Modeling Perspectives

Curtis et al. [28] distinguish four common perspectives in process representation: (1) functional represents the process elements or activities being performed; (2) behavioral represents the control-flow or sequencing of activities; (3) organizational represents the agents performing process elements and (4) informational means the information entities such as data, objects, artifacts, products, etc. that are created or handled during the process. These perspectives are shared by proponents of data-centric process modeling methods as shown in Table 2.2.

	<b>Functional/Behavioral</b>	<b>Organizational</b>	<b>Informational</b>
<b>Bhattacharya et al. [8]</b>	verb-centric: actions taken to achieve a goal; how things are processed		noun-centric: what is acted upon
<b>Luo &amp; Tung [34]</b>	activity perspective: how things are done; activities and relationships between activities	role perspective: who performs the activities	object perspective: informational entities handled or produced by a process
<b>Wang &amp; Kumar [35]</b>	process-based: processes consume, produce or transform information under a set of business rules	organizational-based: focus on utilization of organization resources	information-based: views processes as operations that are triggered as result of information changes

Table 2.2 Process Modeling Perspectives



Likewise, workflow specifications may be seen from a control-flow, data, resource and exception handling perspective [36]. Other approaches in workflow modeling consider the goal perspective; here the focus is on the higher level goals or business process objectives and their decomposition into lower level workflow schemas satisfying those goals [37]. Note from Table 2.2 that the classifications shown consider the functional and behavioral perspectives joined in the process-perspective: the activities and their sequencing.

Although processes are considered to be a combination of data, control and resources, the mainstream business process modeling techniques focus on the activities and their control flow [35,38] while the other perspectives are usually incorporated as a late addition.

### 2.3.2.1 Activity-Centric Process Modeling

As mentioned before, traditional techniques emphasize on the set of activities that stakeholders need to execute, the relations between them and their order of execution. A well known work in this tradition is the Workflow Patterns<sup>1</sup> initiative which initially described a vast set of control-flow patterns. Control-flow patterns describe the logical dependencies between various tasks such as sequencing, parallelism, synchronization, exclusive choice, etc.

Despite the popularity of techniques and tools based on the traditional approach, several limitations have encouraged the appearance of alternative methods that attempt to cover such restrictions. In general, activity-centric paradigm is effective when supporting standardized and production-oriented domains [38], i.e. processes that are highly structured and repetitive. In other less structured processes, models are kept simple by defining idealized versions of the actual processes and reducing its flexibility; this is done because adding all the exceptions and non-trivial scenarios into the models makes them complex and non-transparent for stakeholders. In the first case, users consider the prescribed process as too restrictive and inflexible and many times they end up bypassing the BPMS [7]; the second case leads to problems of maintainability and management because of the complexity of the process models [7].

### Limitations

Although activity-oriented modeling is the most used and accepted approach, this paradigm has several limitations. Table 2.3 shows a summary of the main issues of activity-centric modeling as pointed out by a number of data-centric modeling

---

<sup>1</sup> <http://www.workflowpatterns.com/>

approaches. The main problems can be grouped in four dimensions: contextual data, flexibility, process coordination and usability. The core problem, as suggested by van der Aalst, resides in the fact that routing is the only mechanism driving the workflow [7]. This classification is not absolute; notice for example that the usability problems as seen by the Case Handling approach derive from the fact that flexibility is provided by complex flow structures or by minimalistic approaches.

	Contextual Data	Flexibility	Process coordination/ consolidation	Usability
<b>Document-centric</b> [35]		Flexibility provided mostly by means of complex flow structures		
<b>Case Handling</b> [39]	Data is moved to the background resulting in errors and deficiencies	Workflows are too restrictive and have problems dealing with change. Focus is on what <i>should</i> be done instead of what <i>can</i> be done		Bypass of workflow system may occur if models are kept simple; management and maintenance issues when models capture all exceptions
<b>Data-driven process structures</b> [40]		Lack of flexible adaptation for development processes	Connection between data and process structures must be defined manually, leading to inflexible process coordination	Changes in data models need manual changes in process structure
<b>Artifact-centric</b> [5,41,42]	Hard to understand possible effects of tasks on business entities due to the limited incorporation of data (mainly only as inputs and outputs)		Problems in assembling workflows from existing services. Obstacles in consolidating processes	
<b>Object-centric</b> [38]	Treats real-world objects as secondary, but they are central in resolution of exceptions	Flexibility is provided by allowing runtime deviations or by minimalistic approaches of flow dependencies		

**Table 2.3 Limitations of the activity-centric modeling perspective**

Other limitations are that work is straight jacketed into activities and that routing is used for both work distribution and authorization [7]. The purpose behind recognizing the traditional approach limitations is to set the background and drives behind the emergence of alternative approaches. Workflow flexibility is a broadly studied topic as can be observed from the number of journals and workshops dedicated to flexible workflow support [7,38]; four ways in which flexibility can be achieved have been proposed: flexibility by design, flexibility by deviation, flexibility by under-specification and flexibility by change [43]. The process consolidation issues relates to consolidation

of processes across organizational boundaries while process coordination relates to the synchronization of a large number of sub-processes. The loss of contextual data causes losing a holistic perspective deriving in problems and errors. Finally, regarding usability, traditional approach may impose burdens on stakeholders in terms of maintainability and management or may make the system more a liability than an asset [7].

### 2.3.2.2 Other process modeling perspectives

The other approaches to process modeling are driven by data, resources and goals as the fundamental entities from which processes are modeled.

#### **Data-centric approaches**

The information-based (noun-centric, data-driven, etc.) perspective focuses on the informational entities handled in a process. These entities may be data, artifacts, products, documents, objects, etc. Process modeling methods based on this perspective use these entities as the central driver of the process modeling. The use of different information entities has derived in multiple methods including product-based, artifact-centric, document-driven and object-centric process modeling approaches, among others. Given the variety of names for this approach, in this document these methods are considered generically as data-centric modeling approaches and they are the focus of study of the next chapter.

#### **Organizational-based approaches**

The organizational perspective focuses on where and by whom in the organization process elements are performed [28]. The most well known work in this perspective is the Role Activity Diagram (RAD) approach by Ould [4]. A RAD shows the roles, activities, events and the interactions between roles in order to achieve a business goal. Process models are centered on the different roles and their interactions.

#### **Goal-oriented approaches**

These methods consider that business processes have to fulfill goals that are shared among process participants and hence they have to influence the design of conceptual process models. Goals are “statements which declare what has to be achieved or avoided in a business process” [44]. These methods are primarily concerned in constructing a process model from its functional goals; goals are broken into sub-goals until they are assigned to activities of a business process. Some methods based on this perspective are the goal-driven workflow modeling [37] and goal-oriented framework for specifying clinical guidelines [45].

Consider an example of the three modeling perspectives as defined in Table 2.2. In Figure 2.3 a simple process of a person entering a public bathroom is illustrated in the different modeling paradigms. The person pays the fee and switches on light; to leave he switches light off. Activity-centric perspective focuses on the tasks and their sequencing; data-centric emphasizes on the objects manipulated in the process and the organizational perspective focuses on the participating roles.

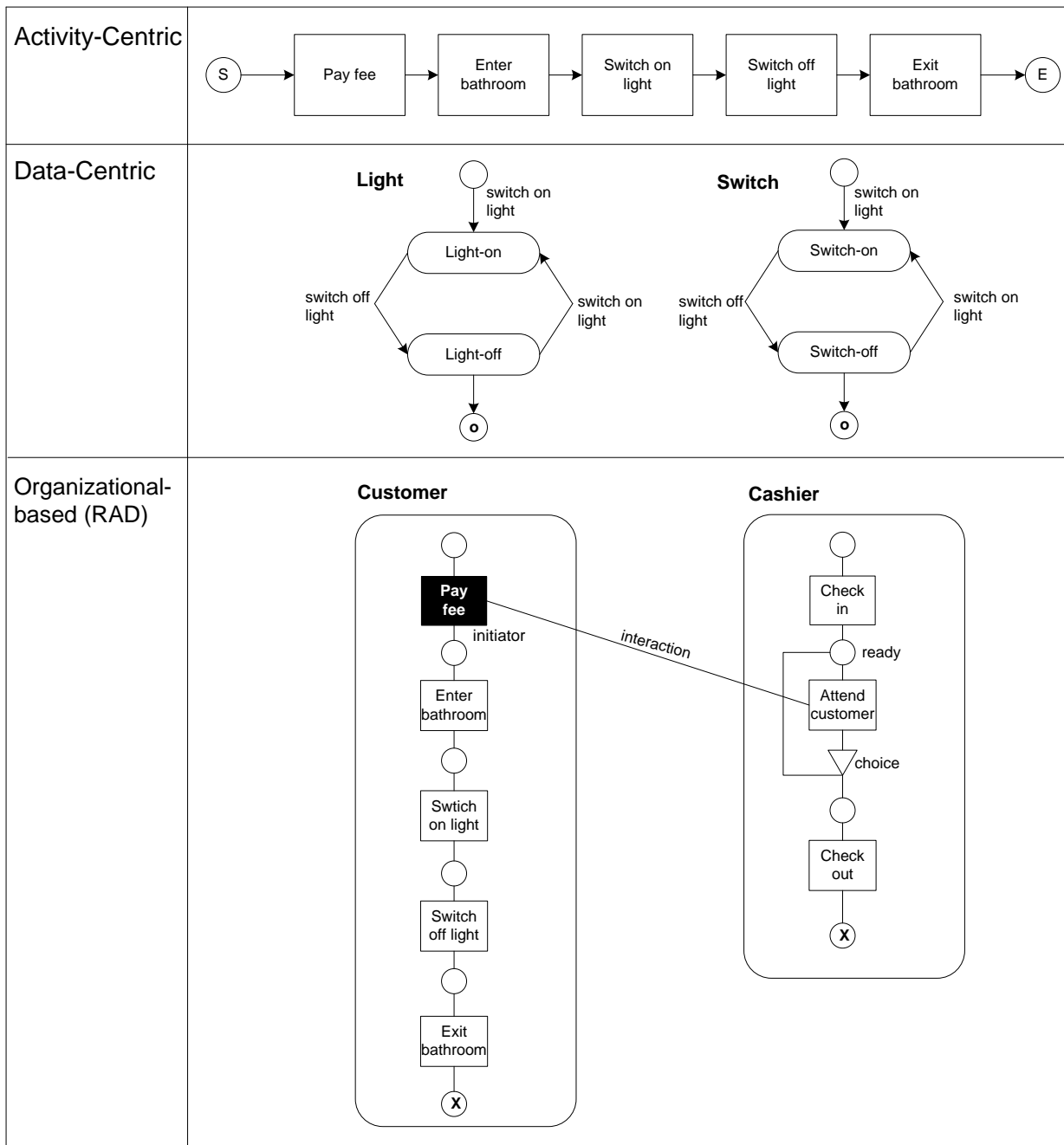

Figure 2.3 Process modeling perspectives (based on [46])

### 2.3.3 Process Modeling Techniques

As business process modeling becomes more popular the number of modeling techniques and tools increase. Techniques are used to express models by means of their constituting modeling concepts which allow modelers to explain reality in a certain way. Modeling concepts are characterized by their notation and their meaning.

Metamodels are a common approach for specifying modeling languages; they contain the concepts, notations and relations that can be used to model processes. Metamodeling is standardized in the Meta Object Facility by the Object Management Group as shown in Figure 2.4. Metamodels describe process models by means of notations; process models are used to describe process instances.

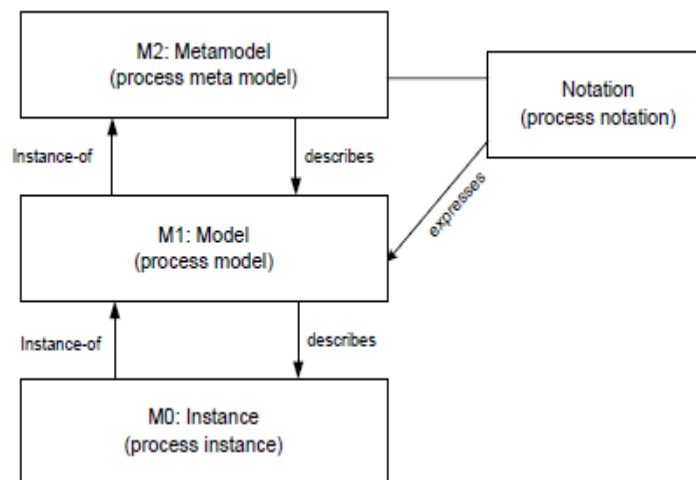

Figure 2.4 MOF Levels of process aspect [23]

A process model language consists of the syntax (notation) and semantics to specify a business process. The syntax of the language provides grammar, a set of constructs often represented by graphic symbols and rules for combining the constructs to create representations [47]. Semantics defines consistent interpretation for the process model to reflect the underlying process logic [48].

## 2.4 Techniques for Evaluation of Business Process Modeling Methods

As Business Process Management becomes more popular, more and more process modeling methods appear. Their evaluation becomes necessary since it: (1) allows for an understanding of their strengths and weaknesses, (2) serves as guidance for the next generation of methods, (3) serves as a tool for selecting methods and (4) it helps finding out which method is more suitable according to a given situation [11]. Siau & Rossi [11] made a review of the different Information Modeling evaluation techniques; these are broadly classified into non-empirical and empirical techniques as summarized in Table 2.4. The classification is complemented with practice descriptions as an empirical research method as proposed by Wynekoop [12].

<b>Non-Empirical Evaluation Techniques</b>	Feature Comparison	It is the most popular way of comparing methods. Researchers develop a checklist of method features and evaluate methods across them.
	Metamodeling	Consists of the use of a common metamodeling language and the mapping of methods to this super method. It can also relate to comparing models of methods by identifying their common parts.
	Metrics Approach	Compares methods through the use of metrics that measure the complexity of diagramming techniques. Metrics include the number of object types, number of relationship types, number of properties for a given object type and other aggregated metrics.
	Paradigmatic Analyses	These techniques apply a number of metaframeworks to position methods according to their underlying paradigms, i.e. their view of how Information Systems should be defined, view of the language, etc.
	Contingency Identification	Provide heuristics for minimizing risks and identifying the problems that are tried to address with the methods.
	Ontological Evaluation	Evaluates the constructs in existing methods by matching them with ontological constructs.
	Cognitive Psychology Based	Based on the cognitive aspects of modeling, for instance, the use of informational and computational equivalence for comparing methods.
<b>Empirical Evaluation Techniques</b>	Survey	Surveys gather data on attitudes, opinions, impressions and beliefs of subjects via questionnaires. Proponents of the technique suggest that the perceptions measured are important since the adoption of methods is based on their perceived usefulness and perceived ease of use.

Laboratory Experiment	Researchers manipulate independent variables (modeling constructs, methods, etc.) and measure the effect on the dependent variables (accuracy of modeling, accuracy of interpretation, etc.)
Field Experiment	Similar to laboratory experiments but taking place in real organizational settings.
Case Study	The subjects using a particular modeling method are observed by the researchers without any intervention. The objective is to describe the reality of a particular environment at a point in time.
Action Research	Researchers become part of the research by affecting and being affected by it. Generally, researchers take part as consultants and report their experience.
Practice Descriptions	Proponents accept practice descriptions as legitimate source of information on methods evaluation, though from a biased perspective.

Table 2.4 Process Modeling Evaluation Techniques (from [11,12])

Research in methods comparison has focused on non-empirical techniques and in particular on the construction of feature-based frameworks; in contrast, practical evaluation has been addressed only in a limited manner [12]. On this respect, Gemino & Wand propose a classification of procedures for empirical evaluation of conceptual modeling techniques [47]. This framework is based on the notions that simple comparison of methods based on their output models is shortsighted and an emphasis should be placed in the modeling language. Two perspectives are distinguished: (1) product i.e. the models obtained from the conceptual modeling and (2) process, the cognitive activity of understanding or creating a model. Furthermore, the focus of observation may be in the model creation or the model interpretation. Figure 2.5 shows the relations between these perspectives.

Criterion for comparison	Focus of observation			
	Script creation		Script interpretation	
	Product	Process	Product	Process
Effectiveness	Physical model (script)	Creating a model	Cognitive model in viewer	Understanding the model
Efficiency	Effort required to create a script		Effort required to interpret a script and develop domain understanding	

Figure 2.5 Perspectives for Empirical Evaluation of Process Modeling Techniques [47]

### 2.4.1 Selection of Evaluation Techniques

The use of different research methods and evaluation techniques is desirable since it provides a richer understanding of a research topic by focusing on different aspects of reality; the use of different methods for analysis allows to validate data and results, to discover fresh or paradoxical factors or to expand the scope of study by covering wider aspects of a situation [49]. Furthermore, the selection of business process modeling methods is influenced by conceptual and practical aspects [34] that need to be addressed and evaluated with adequate methodologies for each particular aspect. With these ideas in mind, data-centric approaches are evaluated in a holistic manner from a non-empirical and an empirical perspective. Non-empirical evaluations can help in better understanding the conceptual nature of the methods while empirical evaluation can report on practical adoption aspects that cannot be explained solely by theoretical studies.

For the non-empirical evaluation, a feature comparison technique was selected since: (1) it is the most accepted technique, (2) data-centric approaches are relatively recent and feature comparison provides a first glance at methods' characteristics that seems appropriate for the early stages of comparison studies, and (3) some methods are still evolving without a single dominant perspective for some of their elements (e.g. the wide variety of metamodels for artifact-centric approaches) making the selection of a single one a difficult task.

The empirical evaluation consists of two parts. (1) Practice descriptions are studied to obtain insights of the benefits and problems of the applications in real scenarios. Although there is a recognized bias for reporting only successful cases, an analysis of a number of cases could reveal patterns of outcomes of the methods' use [12]. (2) Following the propositions of Gemino & Wand, the empirical evaluation emphasizes the process modeling method from a script creation perspective. Particularly, this is analyzed focusing on the modelers' perceptions on the usefulness and ease of use of the modeling approaches based on the Method Acceptance Model [13]. Modelers' perceptions are collected via a survey, in which they evaluate the application of some methods on a common case.



### 3 Non-Empirical Evaluation of Data-Centric Modeling Approaches

The limitations of the traditional activity-centric process modeling have promoted the development of alternate methods that try to reconcile the data and process perspectives by treating information as a “first class citizen”. Numerous academic and industrial initiatives have resulted in a variety of methods with their own methodologies, metamodels and respective supporting tools. This chapter presents a literature review of the different methods and the feature-based evaluation framework. Section 3.1 describes the methodology followed for the non-empirical evaluation. Section 3.2 presents the selection of methods. Section 3.3 provides a review of the selected data-centric modeling approaches. Section 3.4 describes the features selected and Section 3.5 presents the feature-based evaluation.

#### 3.1 Methodology

The theoretical or non-empirical evaluation of the data-centric approaches is based on a feature comparison technique. The construction of the evaluation framework consisted in the following phases:

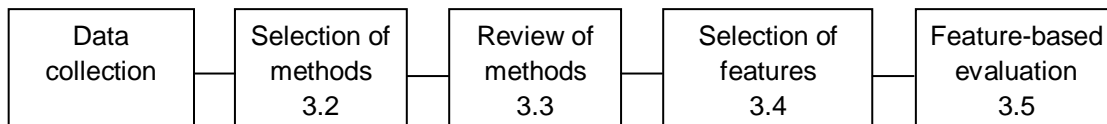

Figure 3.1 Non-empirical evaluation methodology

The data collection protocol defined in Section 1.31.2 was used to identify the distinct data-centric process modeling approaches. A set of them was selected to be analyzed in detail. From this review, a number of characteristics were selected to create the framework and to perform the feature-based evaluation. Each phase will be detailed in the remaining of this chapter.

#### 3.2 Selection of Methods

As result of the literature collection protocol, several methods attempting to reconcile data and process perspectives were identified. Due to scope limitations of the present research only a selected number of approaches are studied in detail. The selection

criterion was the number of citations per modeling approach. The selection procedure was performed as follows:

- 1) A list of publications and their citation count according to Google Scholar was obtained. The citation count is considered in this study as an indicator of the influence of an article. Since many publications may relate to a particular modeling approach, the most popular publication was used as reference; for most of the methods this publication corresponds to the seminal paper or the publication where the method was first introduced.
- 2) To obtain the most relevant studies, the methods in the higher half from the median value of the citations count were selected. The median value was considered since it is less susceptible to outliers and skewed data than the average and other centrality measures.

See Appendix B. Methods Selection for the analysis made for the selection of methods. A first examination of the methods resulted in the identification of characteristics that refer to the way that the distinct methods integrate the data perspective. These characteristics, besides being meaningful for the feature-based analysis, are useful to present the methods' review by means of classes of related methods. Basically, three groups are identified: 1) methods that link the object-oriented modeling and process modeling perspectives; 2) methods that define business processes based on objects' lifecycles; and 3) data-driven execution methods, methods that determine the sequencing of tasks based on the availability of data elements. These groups will be detailed in the remaining of this chapter. Selected methods are shown in Table 3.1.

<b>Bridging</b>	WASA <sub>2</sub> [50]; TriGSflow [51]
<b>Object lifecycle-based</b>	Artifact-centric process models [5,52,53]; data-driven process structures [54]; object-lifecycle compliant processes [55]; object-centric process models [38]
<b>Data-driven execution</b>	Product-based workflow design [9]; document-driven workflows [35];

Table 3.1 Selected Methods

Note that the object-centric process models method [38] does not comply with the defined selection criteria. As discussed later, increasing process flexibility is one of the main motivators of data-centric methods and the non-empirical evaluation performed precisely emphasizes that aspect. Due to this, a second purposeful, intensity sampling was performed; this type of sampling seeks for information-rich cases that manifest the phenomenon intensely [56], in this case process flexibility. This selection round resulted in the incorporation of object-centric process models, a method inspired in flexibility patterns.

### 3.3 Review of Modeling Approaches

This section presents a review of methods classified according to their data integration approach as defined in the previous section. First, a description of the type of data integration in process modeling is given and then a review of the methods supporting such data integration perspective.

#### 3.3.1 Bridging Methods

A number of approaches recognize the use of object-oriented modeling methods as mainstream for the analysis, design and development of information systems [57,58]. Object-oriented technology and workflow systems have had an independent evolution with their own formalisms, methods and tools and the bridging methods attempt to use the object-orientation principles to reconcile the process and data perspectives.

The separation of concerns is one of the principles for ensuring adaptability and maintainability of software systems; it dictates to keep process aspects separated from the domain model [59]. Domain modeling is mainly concerned with the specification of business object types, associations, their intra-object and inter-object behavior, and the relations between object types using notations like Unified Modeling Language (UML) class, state and collaboration diagrams [58]. The process aspects refer to the way of working in terms of actors, activities and workflows. Bridging methods respect this principle by only linking the domain modeling and process modeling products; this implies that process models are still created independently in an activity-centric perspective but, as will be explained in more detail, they are restricted by the behavioral aspects of the object types. Promoters of the bridging methods argue that the use of object-oriented technologies in workflow and process modeling can bring the same benefits as in software development processes, namely, the reuse of components and increase of maintainability [57,58,60]. A summary of the overall benefits in workflow modeling due to the integration with object-oriented modeling is shown in Table 3.2.

---

<b>Reusability</b>	Allows the reusability of data format descriptions [57] and the reuse of methods of objects in the implementation of activities. Object-oriented methods result in workflow object classes that can be reused, ported and adapted [57,60,61].
<b>Maintainability</b>	Because of its modularity and encapsulation, required changes in the functional part in an object-oriented implementation can be limited to the object classes involved [61].
<b>Complexity</b>	Use of OO analysis and OO design in workflow systems can help in managing complexity as in during software development [57].

---

Table 3.2 Benefits of integration of object-oriented and workflow modeling

Although it is not a process modeling approach, the analysis begins with MERODE, a methodology that illustrates the principles of object-oriented modeling and the metamodel that bridges the concepts of object-oriented and process modeling. After that, it follows a review of TriGSflow and WASA<sub>2</sub>, a couple of methods based on this *bridging* perspective.

### 3.3.1.1 Bridging Object-Oriented Modeling and Process Modeling Domains

Model-based Existence-Dependency Relationship Object-Oriented Development (MERODE) is an object-oriented systems development and enterprise modeling method from the early nineties that stemmed from the need of formality for verification and lacking of validation in other analysis methods. Similarly to other object-oriented paradigms, MERODE suggests a close tie of data and behavior around the concept of an object.

A system is considered as a set of interconnected objects. Objects should satisfy the following requirements [60]:

- An object has a state. The state of an object can be described by its attributes.
- An object shows some behavior
- An object corresponds to a real world concept
- An object has an identity
- An object exists for a period of time
- An object is always involved in at least two events: its creation and its ending.

A business model consists of object types, event types and the relationships between object types and event types. The static or structural aspects of object types are described by entity-relationship diagrams and an existence dependency graph; an object is existence dependent of another object if the life of the first object is contained in the life of the latter.

Objects interact with each other by being jointly involved in business events. Events are atomic units of action that can act upon an object by creating it, modifying it or ending it; in other words, they change the state of an object. An object-event table shows for each business event type the object types in which it acts upon and their effect on each object. Furthermore, object methods are defined based on the identified business events.

Finally, the behavior part is modeled also with sequence constraint diagrams. Business events are not allowed to occur in a random way during the lifecycle of an object, so they are subject to sequence constraints. The allowed sequence of events is described

by means of finite state machines or Jackson System Development (JSD) diagrams. Every object has a variable indicating its state and a description of the allowed sequences of event types.

Figure 3.2 shows the three basic constructs in MERODE for a library example. Part a) shows the object-relationship schema; part b) is the object-event table that indicates the action (create, modify or end) of each business event on the business objects and part c) shows the allowed sequencing of events in a finite state machine. The products of enterprise modeling methods like MERODE are used for implementing systems in classical and object-oriented environments. Business events are used as the key entities for linking the object-oriented and process perspectives.

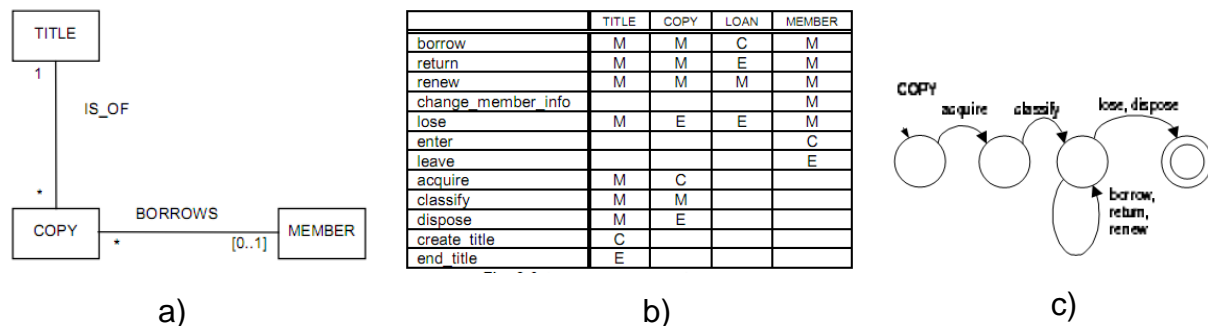

Figure 3.2 Illustration of MERODE basic constructs [60]

The object types, their internal behavior and the relations with each other are usual constructs of domain modeling. These constructs represent the data and functional structure; their isolation from the control or process part is a typical characteristic in traditional workflow modeling: the function-oriented part is supposed to be given while the control part is modeled and supported [61]. This lack of a functional view in process modeling causes that affectations in the functional part due to process changes may not be clearly detected. Business events are the key entities for linking the object-oriented and process modeling perspectives. The model in Figure 3.3 links the domain tier and workflow tier through business events. Business processes are modeled in terms of activities that indicate which business events they invoke; in the domain model, object classes indicate by which business events they are affected and business events also trigger the execution of an object's methods.

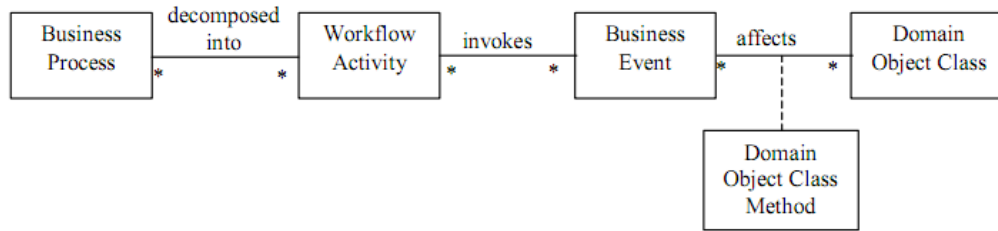

Figure 3.3 Metamodel for conceptual modeling [61]

As observed in the metamodel the key aspect of the integration of the data and process perspectives is linkage in the form of reusability of object's methods in workflow activities. It has to be noticed that both perspectives allow the definition of behavioral aspects in terms of sequencing of business events: in the domain layer by means of object state charts and indirectly in the workflow by defining sequences of tasks. To prevent inconsistencies, a distinction of types of constraints in business rules and business policies is proposed to separate business process aspects from object behavior. Business rules are those that always hold and should never be broken; these are placed in the domain model. Business policies are those that can be broken occasionally and they are placed in the process layer. From another perspective, sequences that come from a particular way of working are defined in the workflow part, and sequences that are inherent to the business should be put in the domain model [59]. This of course depends on the specific domain where the methodology is applied. This division has a way of preventing sequences violation in the process model; every time that a task invokes a business event this is validated in the domain layer, if a sequence is violated, then the event is rejected. However, this cannot prevent sequence violations of workflows at design time.

The following modeling approaches integrate objects' methods already existing in software systems into single workflow applications. From a pragmatic perspective, these approaches are suitable for organizations with a tradition of object-oriented technologies in their IT infrastructure that want to align their workflow facilities with that approach.

### 3.3.1.2 TriGSflow

TriGSflow is an object-oriented workflow system aiming to obtain the reusability and adaptability of the object-oriented principles into the process domain. This approach is based on three main principles: 1) it uses an object-oriented database system (GemStone) to build a workflow model; 2) it defines a role model to decouple activities from particular persons; and 3) it applies Event-Condition-Action rules for flexible execution of activities and coordination of resources [62].

As stated before, in object-oriented environments, the behavior of objects is realized by methods associated to classes. These methods are reused in TriGSflow for the implementation of activities linking the object-behavior modeling with process modeling as proposed in the metamodel in Figure 3.3. The rule-based paradigm specifies system behavior additional to the local object behavior in the domain modeling.

### 3.3.1.3 WASA<sub>2</sub>

WASA<sub>2</sub> [50] is a similar approach supporting the integration of business objects in workflow applications. It allows the initiation of external applications in heterogeneous environments to implement workflow activities and the integration of domain-specific business objects; it also allows dynamic modification of workflow instances. The approach is intended to provide workflow support in heterogeneous system environments so its platform is based on middleware standard CORBA and object-oriented design with UML.

## 3.3.2 Object Lifecycle-Based Process Models

The group of object lifecycle-based modeling methods also recognizes the maturity and extended use of object-centric modeling but, unlike the bridging methods, these methods do not only map or embed the informational and process modeling perspectives: they directly execute object-centric process models or generate activity-centric models from them. These methods use objects' lifecycles to provide structure to business process models; they argue that business processes can be seen as a set of interacting lifecycles of information objects. This section reviews object-centric process models from Queensland University of Technology, object-compliant processes from IBM Zurich Research Laboratory, artifact-centric models from IBM Watson Research Laboratory and data-driven process coordination from Ulm University and Daimler Chrysler.

### 3.3.2.1 Object-Centric Process Models

Object-Centric process models approach suggests a metamodel for defining process models centered on objects and a transformation mechanism of such models to activity-centric process models. The method argues that flexible processes can be designed on the base of objects' state machines communicating through signals: a business process model is composed of a set of business object types and their relations [38]. The

metamodel semantics is defined by Colored Petri Nets and it is inspired by three flexibility patterns frequently occurring during process execution [38]:

- Creation flexibility: allows a user to create a task on-demand during the execution of a process.
- Delegation flexibility: allows a user to transfer the control flow and context data from one executing task to a different one.
- Nesting flexibility: allows a user to create instances of sub-processes as needed.

Three business object types are the base of the proposed metamodel [38]:

- Coordination object: coordinates the creation of tasks and their synchronization.
- Job Object: coordinates the execution of a task.
- Referral object: allows referring a case to another coordination object out of the scope of the present one.

Behavior models represent the object's internal and external behavior through the use of communicating finite state machines. A state machine contains states which indicate a relevant phase in the object's lifecycle. The internal behavior of an object is expressed through transitions between states and the external behavior is represented through signals communicating different state machines [58]. State machines are defined using a metamodel inspired in FlowConnect, an object-oriented metamodel like MERODE.

A transformation algorithm from object-behavior models to activity-centric models is defined. Each state defined in FlowConnect contains an input and output gateway. These gateways are mapped each one to a task in the process model, hence generating one pre-task and one post-task for each state. The input set of a pre-task is obtained by analyzing all the incoming signals and transitions. The output set of a post-task is the union of the output gateway and all the outgoing signals in the pre-gateway. The obtained causal dependencies are represented in a heuristics net; the net is converted into a Petri Net in ProM and finally into a YAWL Model. Reduction rules are applied to the YAWL model to combine tasks and to eliminate silent transitions.



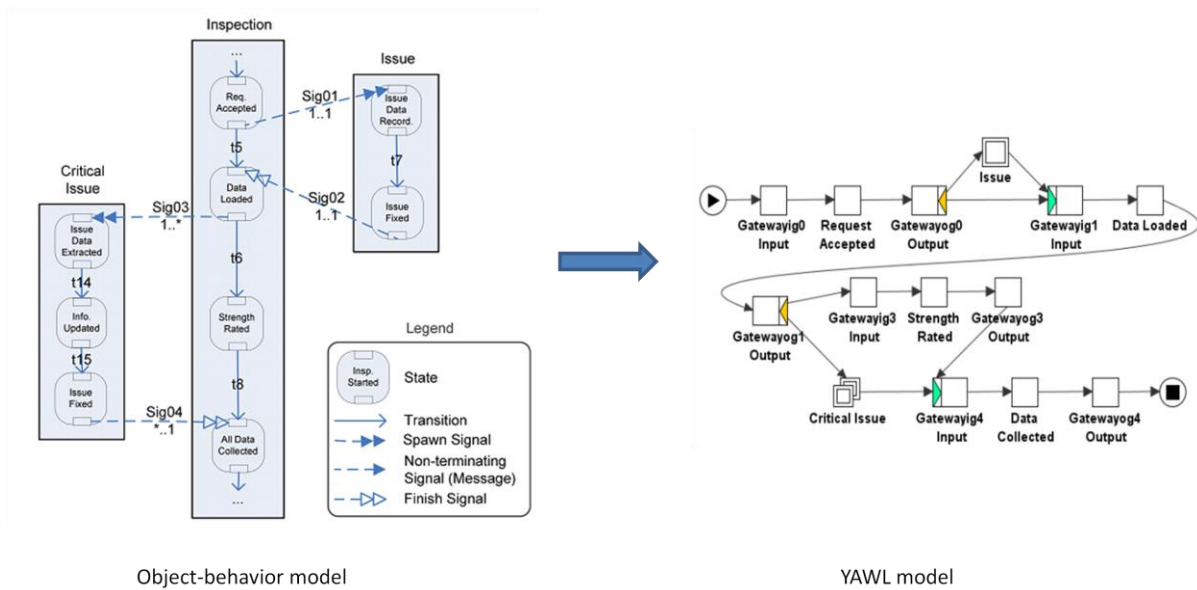

Figure 3.4 Transformation of object-behavior to activity-centric model (adapted from [58])

One prescribed usage scenario is for organizations trying to redeploy and to improve the level of alignment between their business processes and their applications designed based on object-oriented technologies. Transformation is especially useful when projects start using models from an object-oriented perspective and need to be changed to a process perspective [58].

### 3.3.2.2 Object Lifecycle-Compliant Process Models

IBM's object lifecycle-compliant process models are inspired by standardization and regulatory concerns existing in many industries like insurance, banking and healthcare. The objects used in the operations of these industries are standardized by reference data models (e.g. Sarbanes-Oxley, ACORD insurance data standards) that provide a common industry vocabulary that facilitates understanding, interoperability and ensure the fulfillment of legal regulations [55]. Because of these regulations, business processes are required to comply with the object lifecycles. Compliance is typically done by verifying violations in business processes and solving them, but this implies a long and complex process. Instead, the method constructs an activity-centric process model from the reference object lifecycles as a means to secure compliance directly from model construction.

Object lifecycles, usually represented by means of finite state machines, capture the different states and allowed transitions between those states. The transformation process first involves the manual identification of synchronization points. Synchronization events are those that make two or more objects to move to a different

state at the same time. The next steps are done automatically by formally defined algorithms. First, a set of actions is defined from the set of transitions in the object lifecycles; then, the sequencing of such actions is determined by examining their input and output sets. Afterwards actions are combined into process fragments connected to decision and merge nodes and, finally, process fragments are combined to generate a final model presented as an UML Activity Diagram.

A reverse transformation, i.e. from activity-centric process model to and object lifecycle representation, is also possible. This requires the activity-centric process model to include metadata to identify objects types and input/output states.

The key differences with object-centric process models reside in:

- 1) the target model notation. YAWL in object-centric models and Activity Diagrams in object-compliant models. Activity diagrams are flat meanwhile YAWL allows sub processes [58]. Nevertheless, the target language could be changed in both approaches;
- 2) the transformation method is fully-automatic in the object-centric approach while in object-compliance models synchronization points need to be identified manually; this is due to the fact that in the latter method there is no explicit communication between different state machines through signals;
- 3) object lifecycle-compliant method provides a transformation from object lifecycles to activity-centric process models and vice versa.

### 3.3.2.3 Artifact-Centric Process Models

IBM's proposal for the design of data-centric business process models is based around business artifacts and their lifecycles. Initial works based on the artifact concept define Operational Specifications of a business [52] and from there many research efforts, methods and metamodels have originated.

#### **Definition of Artifact**

An artifact, sometimes referred as a business record, is a concrete, identifiable, self-describing piece of information through which business stakeholders add value to the business [52]. They are key business-relevant objects that combine both data and behavioral properties that are used as primitive driving the process modeling [5]. Their main difference with objects as considered in object-oriented techniques is that "artifacts are pure instances rather than instances of a given predefined class" [52]. Typical examples of artifacts are *customer orders*, *insurance claims*, *invoices* and *trouble*

*tickets*; all of them contain a set of attributes and data that allows evaluating how business process goals are achieved.

Clearly, the features of classes are not missing in artifact-centric approaches. Instead, all such features are merged into the artifacts. In an Object-Oriented context, this would mean duplicating all class attributes into the objects that conform to that class. A business artifact can be characterized by the following properties [52,63]:

- A business artifact is a record meaningful to the business user.
- A business artifact has a unique identity and therefore cannot be broken up and reassembled.
- A business artifact is self-describing and contains all information pertinent to the business context.
- A business artifact has a lifecycle that describes the phases from its creation to completion.

The claimed benefits of the artifact-centric approach are layered around three dimensions as shown in Table 3.3. The approach argues that a business process can be defined as the process of business entities walking through their lifecycles, from their initial states to their final states. For each artifact in business, its lifecycle can be constructed and the collection of artifact lifecycles and the interaction between them specify operational models of the business; the state of a process is given by a snapshot of all artifacts at any time [5].

<b>Understanding and Communication</b>	Artifacts are basic blocks that enable a natural communication and intuitive way of thinking of business people about their operations [52,64]. The agreement on artifacts and its facilitation of communication is especially useful when consolidating business processes across boundaries (e.g. mergers or acquisitions) and in business transformations [42]. Artifact-centric models behavior use only a few business entities, reducing its size and complexity [6].
<b>Reusability/ maintainability</b>	Its design methodology allows changing at conceptual and workflow levels while preserving the same operations model [5]. The establishment of a library of artifact services enables their reuse and workflow composition [53]. It allows defining generic process models, “a family of variants of the same workflow model” [65]. A generic workflow schema is defined and it can be have multiple variations (e.g. in sequencing of services) to adequate to special circumstances [53,66].
<b>Execution</b>	Despite the fact that artifact-centric models are expressed in a way that is intuitive for business people, they include the formality needed for their automated implementation in a variety of tools [64].

**Table 3.3 Benefits of artifact-centric process modeling**

## Business Operation Models

The artifact-centric design methodology is based on the definition of a Business Operation Model (BOM). BOMs are defined across four different dimensions whose variations lead to a family of related artifact-centric process models. The four dimensions are: (1) business artifacts, (2) lifecycles, (3) services, and (4) the associations of services to artifacts. The definition of these dimensions provides a process specification at the logical level which is independent of a specific realization. BOMs serve as basis for system implementation and they are used as input for the conceptual flow and workflow realization phases. The four dimensions, which form the so-called BALSAs framework, are defined as follows [5]:

- **Business Artifacts Information Model.** The information models of artifacts are intended to hold all the information needed when completing business process execution. An artifact has an identity, it is traceable across the workflow and it contains the data and attributes that record information about the business operations. Common data models used for describing artifacts are nested name-value pairs, entity-relationship schemas and XML.
- **Macro-level Lifecycles.** Lifecycles represent key stages in the evolution of an artifact, from its creation to its final disposition and archiving. Lifecycles can be represented as a Finite State Machine or as state charts.
- **Services.** Services are units of work that make changes to one or more business artifacts. They may be fully automated or may involve human activity. Typically, several services are applied during each stage of the lifecycle of an artifact. Services are specified by their input and output artifacts and attributes, preconditions and conditional effects (IOPEs) or by more structured graphical representations. Services are defined in a manner largely independent of their sequencing providing a “library” of services associated to a family of artifact classes.
- **Associations.** Associations are used to constraint sequencing of services and to relate services and artifacts to form the micro-level lifecycle of artifact. Constraints may be defined using procedural techniques such as Flow charts and Petri Nets or by means of declarative specifications such as Event-Condition-Action rules (ECA rules). Rules specify the conditions to invoke a service and a set of rules define the business process.

The basic form of the framework, *BALSA Basic*, consists of Entity-Relationship models for specifying artifacts; finite state machines for lifecycle definition; definition of input, output, pre-conditions and effects for service specification; and ECA rules to define associations between services and artifacts. Other forms of the framework are based on

metamodels with artifacts, tasks, repositories and flow connectors as fundamental elements [67].

## Other Developments

Many research initiatives have stemmed from the artifact-centric paradigm. Regarding model transformation, Kumaran et al. define an algorithm for transforming activity-centric process models into artifact-centric models based on the identification of business entities and the input and output entities of each activity [6]. Battacharya et al. performed a static analysis of the reachability, dead-ends, redundancy, persistence, uniqueness and arrival properties of artifact-centric process models [8,68]. Liu et al. defined operational patterns that describe the most common behavior of artifacts [69]. Artifacts are used as the modeling paradigm in the Artifact-Centric Service Interoperation (ACSI) project<sup>2</sup>, an initiative supporting service collaborations across enterprises by means of interoperation hubs structured around business artifacts.

### 3.3.2.4 Data-Driven Modeling and Coordination of Process Structures

Data-driven process structures<sup>3</sup> [40,54] is another approach for process implementation rooted in the automotive industry. Its main objective is to reduce modeling efforts by increasing model reusability and maintainability [54]. The method argues that often the dependencies of sub-processes and their synchronization are strongly related to the relations existing between the product components. Coordination of such processes, called data-driven, and their dynamic adaptation on runtime are the main drives of the method.

The modeling framework is composed of the following elements [54]:

- **Data model.** Describes the structural properties of a product consisting of object types and their relation types. An object type represents an abstract or physical component and a relation type represents a single relationship and cardinality between two objects. In manufacturing environments, this can be related to product component schemas similar to those generated by Product Data Management Systems.
- **Lifecycles.** Define the internal dynamic behavior of an object through state transition systems. Each object is associated with a lifecycle representing the

---

<sup>2</sup> <http://www.acsi-project.eu/index.html>

<sup>3</sup> Be aware that the term data-driven modeling refers to a modeling approach while data-driven execution refers to one of the types of data integration defined in section .

different stages of an object through its lifetime. Conditional internal state transitions represent processes that modify an object and induce a state change.

- Lifecycle Coordination Model.** Defines the dependencies between different object lifecycles through external state transitions. State transitions of an object lifecycle do not depend exclusively on their internal processes but also on the states and state transitions of other objects. External transitions represent synchronization points between objects but can also be associated with the enactment of a process. The set of all lifecycles of all object types and their external state transition forms the Lifecycle coordination model.

These elements at model level are used to instantiate data structures and their related data-driven process structures as illustrated in Figure 3.5. A data model is defined for a product (step 1); then, a lifecycle is defined for each object and the coordination model indicating the relations between objects' lifecycles (dashed square in step 2). At instance level the data model is used to create data structures and their corresponding process structure (steps 3 and 4).

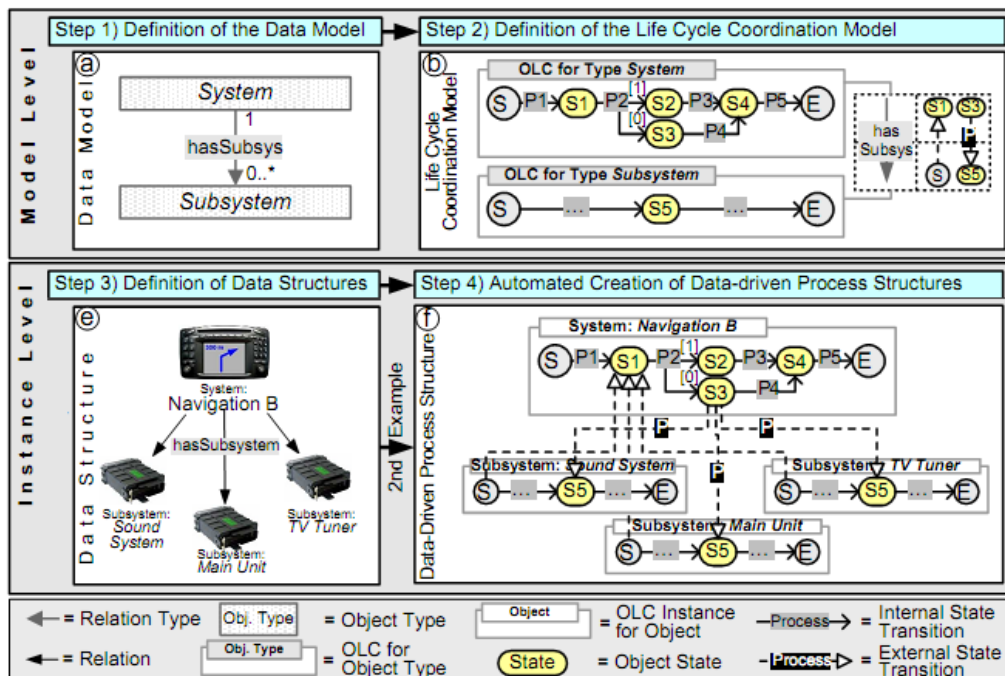

Figure 3.5 Creation of data-driven process structures [54]

Notice that, unlike artifact-centric approach, the method neglects descriptive object attributes in the data model since it argues that they do not influence the generation of the requested process structures.

Regarding dynamic adaptation, the method allows changes at data and process during runtime. It translates changes at the product (data) structure into their corresponding adaptations at the process structure while validating the adaptations to preserve consistency. Changes are permitted at the following levels: data structures, internal object lifecycle, object lifecycle structures and process and data states [40].

### 3.3.3 Data-Driven Execution Methods

The set of methods considered in this section argue that the dependencies between data elements can be used to derive workflow models. Furthermore, the sequencing or enablement of tasks is based on the data objects available. The methods considered in this perspective are Product Based Workflow Design, document-centric workflows and Case Handling approach.

#### 3.3.3.1 Product-Based Workflow Design

Product-Based Workflow Design (PBWD) is a data-centric business process (re)design method that is inspired by the manufacturing field, where production processes are derived from the Bill of Materials (BOM), i.e. production is driven by the structure of the product. The kinds of products considered in PBWD are information-intensive or administrative processes such as the handling of insurance claims, mortgage loans, etc. [9]. PBWD suggests that dependencies between data elements of such products can be used to generate workflow model designs. The method takes an analytical clean-sheet approach, meaning that the process is designed from scratch without considering existing processes or reference models and it privileges the use of formal theory techniques to derive process designs over participative approaches.

#### **Product-Data Model**

A *product-data model* is the central entity in PBWD for deriving a workflow model; it is composed by data elements and their logical dependencies. A product-data model consists of [9]:

- A set of data elements with a special *top element* i.e. the final data element or final *product*.
- Production rules indicating the different ways in which a data element can be produced based on the value of other information elements.
- A set of constraints that apply to each production rule: a production rule can only be applied if its correspondent constraints evaluate to true.

- The cost of using each production rule.
- The time that takes to use a production rule.
- The probability that each production generates an acceptable result.

The product-data model indicates different relations between data elements that can be used to obtain a value for the top element. It is possible that there are no constraints on applying a production rule or that no input data elements are required to produce the value for an element. Cost, time and probability are used as workflow design criteria, but other criteria may be defined as well.

In Figure 3.6 it can be observed an example of a product-data model. The top element, *a*, is the final data element produced in the process. There are three different ways or production rules that can determine the top element, each one represented by an incoming arc into the top element. Consider for instance that the top element *a* consists of a decision on the suitability to become a helicopter pilot; the decision is determined by several data elements such as the psychological fitness, physical fitness and previous results from the last two years (elements *b*, *c* and *d* respectively). Likewise, physical fitness is obtained from the quality of reflexes and quality of eyesight (elements *e* and *f* respectively).

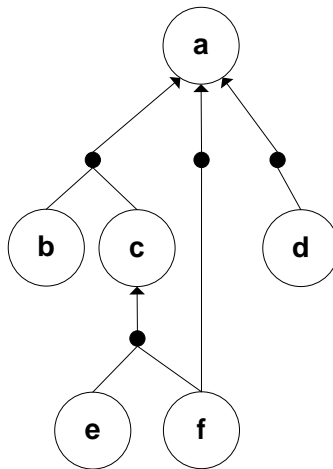

Figure 3.6 Product-data model example [9]

The input data sets of the three rules to determine the top element are:  $\{b,c\}$ ,  $\{d\}$  and  $\{f\}$ . The black dots represent joins of data elements in a production rule, for example,  $\{e,f\}$  are used to determine element *c* and  $\{b,c\}$  can determine *a*. The elements *b*, *d*, *e* and *f*, do not require of any other data elements to be produced and in consequence their production rules have an empty input data set. Constraints, costs, flow times and probability of success can be defined for each production rule as in Table 3.4.



$x$	$constr(x)$	$cst(x)$	$flow(x)$	$prob(x)$
$(a, \{b, c\})$	True	80	1	1.0
$(a, \{d\})$	$*d \in \{\text{suitable}, \text{not suitable}\}$	10	1	0.1
$(a, \{f\})$	$*f < -3.0$ or $*f > +3.0$	5	1	0.4
$(b, \{\emptyset\})$	True	150	48	1.0
$(c, \{e, f\})$	True	50	1	1.0
$(d, \{\emptyset\})$	True	10	16	1.0
$(e, \{\emptyset\})$	True	60	4	1.0
$(f, \{\emptyset\})$	True	60	4	1.0

Table 3.4 Production rules for example of product-data model [9]

### Workflow Generation

A workflow model derived from a product-data model consists of: (1) a set of tasks in which production rules are applied and (2) a set of execution sequences. The ordering of production rules/tasks is driven by optimization on the design criteria. For example, a workflow constructed considering flow time as performance criteria may favor parallel execution of tasks.

Construction of a workflow model from a product-data model can be done either manually, by grouping related data elements and their production rules into specific tasks, or automatically, using a variety of transformation algorithms [70]. Regarding maintainability, the effect of small changes to product-data models, such as addition and deletion of data elements and operations, can be determined in the process model and it may be updated without entirely regenerating it [71].

Translation of the product-data model to a suitable process model is not trivial task and it also conveys a loss in flexibility [72]. An alternative approach allows the direct execution of the product-data model without first generating a workflow model. This second approach, called Product-Based Workflow Support (PBWS) [72], suggests to the user at runtime the most proper task to be executed based on the available information for a case, the product specification and the performance objectives.

Although PBWD and data-driven process structures use data dependencies for deriving workflows, the first is more focused on informational products and the latter in physical products. Also, PBWD does not consider the lifecycles of objects for deriving such process dependencies.

3.3.3.2 Case Handling

Case handling is a paradigm for supporting knowledge intensive processes where the focus is on the data or product being manufactured during the process rather than on a purely control-flow perspective [7]. The core principles behind case handling are the following [39]:

- Prevention of context tunneling. All the information available of a case is provided to workers instead of just selected pieces of information shown when executing a specific task.
- Data-driven execution. Enablement of activities is based on data objects available for a case rather than just in fixed sequencing of activities. Data objects are evaluated through conditions in activities to decide its enablement.
- Data accessibility. Workers can view, add or modify data before or after the correspondent activities are executed.
- Separation of work distribution and authorization. A flexible query mechanism allows workers to navigate through active and completed cases.
- Implicit modeling. A *preferred* or *normal* flow of activities is still explicitly modeled, but available constructs like redo and skip of tasks offer more flexibility during runtime by allowing many execution paths without explicitly specifying them.

Table 3.5 summarizes the differences between traditional workflow management and case handling approaches.

	Workflow management	Case handling
Focus	Work-item	Whole case
Primary driver	Control flow	Case data
Separation of case data and process control	Yes	No
Separation of authorization and distribution	No	Yes
Types of roles associated with tasks	Execute	Execute, Skip, Redo

**Table 3.5 Differences between workflow management and case handling [39]**

In general, a data object is considered as a *piece of information* that carries out a value and which is present or not for a case. State of a case is given by the data objects present in a certain moment and not by the control-flow status [73]. Each activity is linked to a number of data objects. These can be classified as *mandatory* and/or *restricted* data objects. The former implies that a data object must be filled before an activity can be completed and *restricted* objects can only be modified in those activities for which the object is assigned as restricted. A third type of objects, *free*, can be changed anytime while the case is being handled.

Despite the increased flexibility, some shortcomings are also recognized in case handling [73]:

- Data maintenance. The approach requires maintaining all the information for a case that implies redundant data administration and maintenance costs. Possible solutions for this issue also have their drawbacks: moving all data to a case handling system contradicts the principles of original WfMS of keeping the data and process parts separated; making just a selection of the data available would lead to the traditional WfMS approaches.
- Concurrency. By having all data available for a case it is possible that two workers try to modify the same piece of information. Such situations may lead to inconsistencies. Using a lock mechanism to solve this would eliminate possibility of concurrent execution; separating sets of data to avoid this send us back to traditional WfMS.
- Implicit modeling. Offering more flexibility by allowing execution paths not visible in the models makes them harder to understand and demands more participant coordination. Also, many redo tasks may affect the process efficiency.

Some of the commercially available case handling systems include FLOWer from Pallas Athena, ECHO from Digital, Vectus from Hatton Blue and Staffware Case Manager. An alternative approach is to incorporate the case handling concepts in traditional WfMS in an effort to combine their benefits [39].

### 3.3.3.3 Document-Driven Workflows

Wang & Kumar [35] propose a framework for document-driven workflows. In this approach there is no predefined control flow. Their creation requires the input/output analysis of the tasks of a process to discover document dependencies. These document dependencies provide a partial ordering of the tasks that can be refined by defining additional constraints in the form of ECA rules. Tasks of the process are instantiated when their input documents exist. A process ends when the desired output documents are produced and changes to processes are performed instantly by changing constraints. A prototype was implemented in a RDBMS using Transact-SQL.

Drawbacks of the approach include the lack of visualization of the derived process. Critics argue that often some activities such as authorizations, approvals and communicating decisions go beyond pure document processing. The method proposed by Krishnan et al [74] precisely addresses this problem by incorporating in the same framework pure document-processing and other types of activities.

## 3.4 Selection of Features

The methods review provided insights about the concepts and characteristics of each modeling approach. For the evaluation, first it is needed to determine the features that methods will be evaluated across. The features were determined by iterative analyses and comparisons of the methods. Some of the reviewed publications have related work sections in which they make references and, for a few of them, explicit high-level comparisons with other methods; this information provided suggestions on the set of features to compare across. The set of methods was analyzed iteratively and two groups of features were detected: degree of data integration features and methods' drives.

### 3.4.1 Degree of Data Integration

As indicated before in Section 3.2, a first scan of methods resulted in the identification of different ways in which data is incorporated as modeling primitive across the various methods. These three perspectives provide different degrees of data integration.

- **Object-oriented linking.** Methods in this perspective are guided by the principle of separation of concerns and propose bridging the object-oriented and process modeling domains through the reuse of objects' methods.
- **Object lifecycle.** Several methods consider business processes as the process of business entities *moving through* their lifecycles, from their initial states to their final states [6]. Business processes are modeled as a set of object's which behavior is often modeled as state machines that indicate an object's relevant phases and the allowed transitions between them. Object lifecycle models provide the structure from which activity-centric models can be derived or they can be used directly for process execution.
  - **Objects interactions.** Besides providing structure of processes by defining object lifecycles, some approaches extend the object lifecycle approach by defining mechanisms for the synchronization of object instances executing in an independent, asynchronous manner (e.g. external transitions in data-driven modeling of process structures method); this permits the aggregation of multiple related instances and the definitions of coordination points to minimize process coupling [19]. Notice that providing objects interactions implies object lifecycle support.
- **Data-driven execution.** Sequencing of activities depends on a data perspective: activities are enabled based on data objects available for a case rather than just in a fixed sequencing of activities.

Some of these characteristics have also been recognized by other comparison researches. Künzle & Reichert [18] consider object lifecycles, objects interactions and data-driven execution. Similarly, the data-state reaction and data-state coordination proposed by Henriques & Silva [19] may be mapped to the object interactions and data-driven execution categories. The family of bridging methods is not considered in any of the published evaluations.

### 3.4.2 Drives

The posterior analyses of the methods resulted in the identification of several characteristics that are referred here as the methods' drives. Drives are related with the business process modeling concepts that promoted the development of a particular method and/or they intend to achieve. In general, the purposes for which data-centric approaches have been developed may range from: 1) providing better support for specific process modeling objectives (cf. Table 2.1) and 2) pursuing specific domain objectives as described in the methods' reviews (reusability/maintainability, increasing flexibility and context tunneling avoidance). Special attention is given to flexibility, a broadly studied and recurrently detected issue of the activity-centric modeling approaches. The drives and motivators dimension is particularly useful when choosing the most suitable among various methods according to the desired goals of the modeling effort. See Appendix C. Methods Drives and Motivations for a list of the explicit drives and their correspondent references.

## 3.5 Evaluation Framework

The constructed framework is shown in

Figure 3.7. The vertical axis corresponds to the type of data integration. Starting at the bottom part is the object-oriented linking, the *weakest* form of integration; then follows, methods providing structure through objects lifecycles; the next level is objects interactions, a more advanced way of providing structure to processes using lifecycles by providing synchronization mechanisms; and the top element corresponds to data-driven execution, where the sequencing of activities depends on the availability of data elements. The horizontal axis correspond to the modeling approaches drives. The first three elements correspond to a set of the modeling objectives as defined by Curtis [28]; the other concepts are related to the intended benefits of the modeling approaches. Curtis' original classification also includes *automate process guidance* and *automate execution support* as modeling objectives. These categories are not displayed in the framework since all of the methods are intended to be used as basis for controlling

behavior in an automated environment, i.e. all models are intended to derive in execution environments.

Each modeling approach is represented as a rounded rectangle and its size is dependent on the number of concepts they cover from the framework. As a matter of example, consider document-driven workflows which focuses on a data-driven execution type of data integration and its main purpose is to provide increased flexibility; the method is represented by a rounded rectangle of size 1. On the other hand, data-driven process structures integrate data by means of objects interactions focusing as well on increasing flexibility and reusability; this method is represented by the rounded rectangle of size 2 that covers these concepts.

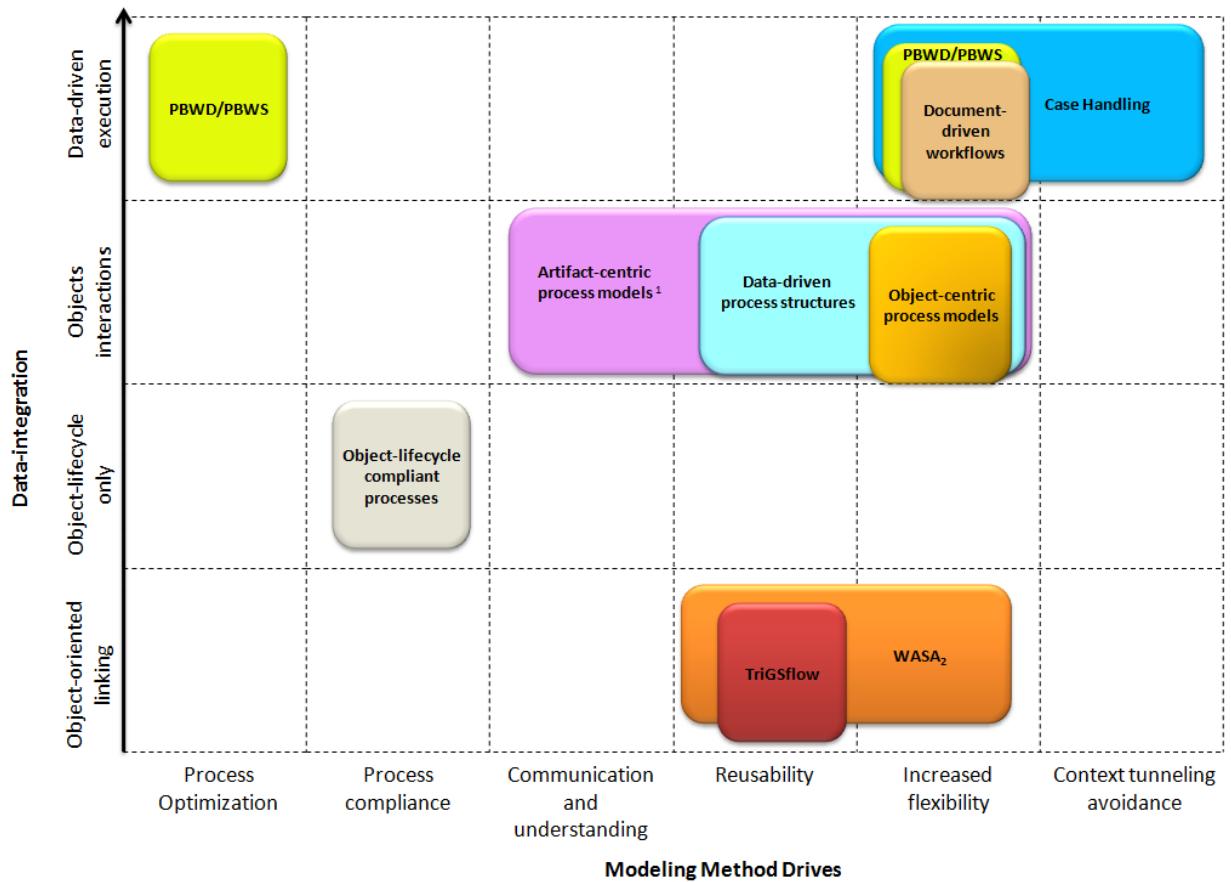

1. Objects interactions supported in declarative specifications (BALSA basic)

Figure 3.7 Classification of Data-Centric Process Modeling Approaches (format inspired in [75])

A drawback of this type of representation is that methods covering not adjacent concepts might be represented in more than one block. Notice for instance in Figure 3.7 that PBWD/PBWS appears twice since the layout of the dimensions does not allow presenting the concepts they cover in an integrated block. It should also be considered

that a method covering a bigger area is not necessarily *better* than another one; the graphic simply reflects the data-integration concepts and motivators from where the methods stemmed from. Furthermore, the graphic reflects that differences in methods may not be essential. Consider for example that artifact-centric process models has an objects interactions type of data integration (of course based on objects lifecycle); if lifecycles are defined according to the specifications provided by regulatory entities, then they may be considered as covering process compliance in the way that object-lifecycle compliant processes do. An example of these methods' *conceptual proximity* is that data-driven process structures could be defined as a procedural variation of the artifact-centric Balsa framework; also, consider the evaluation of case handling systems for PBWD support [76], two conceptually related approaches in the framework.

### Flexibility Evaluation

As identified in Table 2.3, lack of flexibility is one of the main limitations of traditional workflow management systems. Process flexibility can be defined as the ability of a process to deal with anticipated and unexpected changes by adapting the parts of the process that are affected by the change while preserving the essence of the unaffected parts [43]. Schonenberg et al. [43] propose a comprehensive taxonomy of process flexibility that serves as basis for the data-centric methods evaluation. Four different forms of process flexibility are considered in this classification:

- **Flexibility by Design.** It refers to the ability to incorporate known execution alternative paths at design time, allowing the selection of the most appropriate one at runtime. Typical control structures in procedural approaches allowing this type of flexibility include parallelism, choice, iteration, multiple instances and cancellation. In declarative approaches flexibility is achieved by reducing or weakening constraints without having to explicitly define the permitted execution paths. Similarly, implicit modeling allows multiple execution paths without explicitly defining them [73].
- **Flexibility by Deviation.** It allows deviating at run time from the prescribed or allowed execution paths without changing the process models. Operations supporting this kind of flexibility include undo, skip, and redo tasks, creating additional instances of a task and invoking not enabled tasks of a process.
- **Flexibility by Underspecification.** It allows executing incomplete process models at run time, i.e. processes that are not fully defined or that need to be adjusted at specific points in time. This is useful when an overall process structure is known, but the contents of a specific node need to be specified later in time. Van der Aalst [65] proposes to increase flexibility by defining generic process models, “a model that describes a family of variants of the same

workflow process”, that contain process fragments that are defined at runtime. Similarly, Mangan & Sadiq [77] propose creating generic, partially-defined models that are fully-specified at runtime and that may result in a unique model for each instance.

- **Flexibility by Change.** It refers to the ability to modify a process model at run time for one specific or all process instances. Weber et al. [78] define process change patterns as high-level adaptation patterns including adding/deleting fragments, moving/replacing fragments, adapting control dependencies and changing transition conditions; these changes are composed of change primitives like add node, remove node, add edge, remove edge, etc.

Data-centric approaches that argue to increase process flexibility are evaluated based on this classification. In Table 3.6, for each modeling approach it is described the way in which it complies with the applicable flexibility types.



Approach	Flexibility type			
	by design <sup>4</sup>	by deviation	by underspecification	by change
Object-centric	Delegation flexibility: Transfer of the context and data from one executing task to a different one.	Creation flexibility: allows invoking tasks in an unplanned manner.	Nesting flexibility: complement processes by instantiating nested sub-processes as needed	
Data-driven process structures			Although the object lifecycles of objects may be the same, the sub-processes modifying them may be different.	Allows changing data and process at design and runtime while ensuring process soundness
Document-driven workflows	There is no predefined control flow. Multiple execution paths are allowed; paths can be restricted by defining constraints (implicit modeling).			Changes are made instantly by changing constraints.
Case-Handling	Implicit modeling; only a <i>preferred</i> control flow is explicitly modeled	Undo, redo and skip of tasks are allowed.		
PBWD/PBWS	A given product-data model may generate numerous conformant workflow models with different sequencing of tasks according to the optimization criteria.			Updates process designs due to changes to the product-data model (only for PBWD).
WASA <sub>2</sub>				Dynamic changes by allowing workflow instances to be adapted at runtime
Artifact-centric			Object lifecycles provide a generic schema that can be specialized at association levels allowing multiple conformant workflow variations.	

Table 3.6 Evaluation of data-centric approaches by flexibility type

<sup>4</sup> Flexibility by design only considers extensions to the typical control structures (parallelism, choice, etc.)

## 4 Empirical Evaluation of Data-Centric Modeling Approaches

Research of Information Systems has emphasized in the development of new methods while their use and evaluation has been addressed only in a limited fashion; additionally, there is a lack of empirical research in the area [12,13]. Nevertheless, the selection of business process modeling methods and their *success* reflected in their impact and adoption in practice is affected by pragmatic aspects that can be analyzed and measured through empirical research techniques. This chapter presents the description of the empirical evaluation of the distinct data-centric modeling approaches and the results obtained using the two selected techniques: a survey for measuring the Perceived Ease of Use and Perceived Usefulness and the analysis of practitioners' case studies. Section 4.1 presents the evaluation of user perceptions. Section 4.2 presents an analysis of practitioner's case studies, the second technique used for empirical evaluation.

### 4.1 Evaluation of User Perceptions

The first empirical evaluation corresponds to the measurement of the Perceived Ease of Use and Perceived Usefulness of the methods according to the Method Evaluation Model. The evaluation is based on a survey technique in which participants rate their perceptions on the applicability of data-centric modeling methods on a common case. This section of the document introduces the Method Evaluation Model and then each phase of the evaluation approach is described.

#### 4.1.1 Methodology

The evaluation approach consisted in the phases shown in Figure 4.1. First, a number of data-centric approaches were selected for evaluation. Then, a case was selected and the correspondent models were constructed. A questionnaire to measure the user perceptions was crafted. The survey was launched on a web-based tool and finally the results were obtained and analyzed.

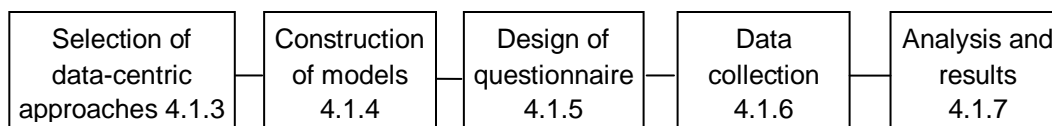

Figure 4.1 Approach for the evaluation of user perceptions

#### 4.1.2 Method Evaluation Model

As suggested by Gemino & Wand [47], the evaluation of modeling approaches by focusing only on the products of modeling (models or diagrams) is limited since different modelers using the same technique might produce different representations of a system, yielding to possibly distinct evaluation results. Instead of this, emphasis should be placed on the modeling technique and in general in the modeling approach. A well known work in this line of research is the Method Evaluation Model (MEM) by Moody [13], a theoretical framework for evaluation of Information Systems design methods. Moody's proposal is based on the Technology Acceptance Model (TAM) [14] which measures technology success based on how users accept or reject it. Moody's model adapts and enhances the TAM to make it suitable for the evaluation of technology design methods rather than the acceptance of particular technology artifacts.

MEM considers two primary dimensions to measure the success of Information Systems design methods: (1) actual efficacy, whether the method improves the performance of the task and (2) adoption in practice, whether the method is used in practice [13]. A summary of the MEM is shown in Figure 4.2. The constructs of the method can be classified in behavioral variables and psychological variables [79]. Behavioral variables correspond to actual aspects of the application of a method [13]:

- Actual Efficiency. The effort required to apply a method; it can be measured in terms of costs, time or effort.
- Actual Effectiveness. Refers to how well a method achieves its objectives by measuring e.g. the quality or quantity of the results.
- Actual Usage. The extent to which a method is used in practice.

Psychological variables correspond to the classical constructs of the TAM and can be defined in their adaptation to the MEM as follows [13]:

- Perceived Ease of Use. The extent to which a person believes that using a method will be free of effort.
- Perceived Usefulness. The extent to which a person believes that using a particular method will achieve its intended objectives.
- Intention to Use. The extent to which a person intends to use a method.

Intention to Use was empirically proven to be determined by the Perceived Ease of Use and Perceived Usefulness. Also, Ease of Use has an indirect affectation on the Intention to Use by its effect on the Perceived Usefulness [14].

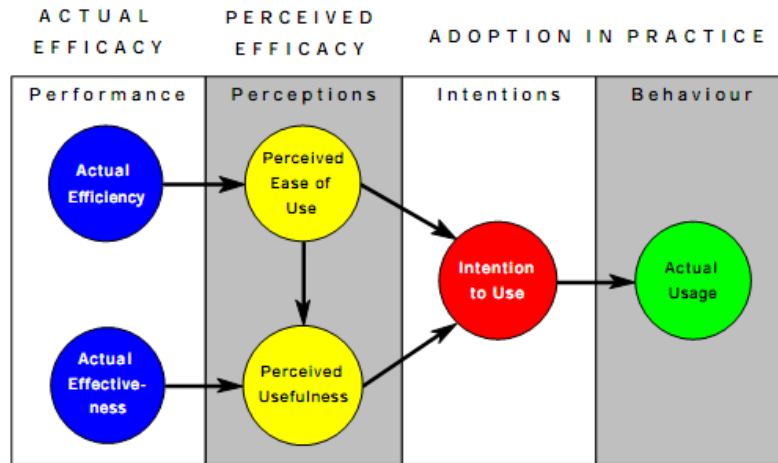

Figure 4.2 Method Evaluation Model [13]

Since some of the methods studied in this work are still in their conceptual phases or they are limited to academic environments, their measurement and adoption in practice is not feasible for all of them, preventing the use of these concepts as evaluation criteria. Furthermore, Moody suggests that Actual Efficiency and Actual Effectiveness affect the Intention to Use and Actual Usage of a method only via the perceptions on Ease of Use and Usefulness: “*subject reality* is more important than *objective reality*” [13]. Based on this, the focus of observation of this study is then on the Perceived Ease of Use and Perceived Usefulness.

The use of TAM and MEM as models for measuring user perceptions in business process modeling has been considered in other research environments. Maes & Poels incorporated TAM concepts for measuring the perceived quality of conceptual modeling scripts [80]. La Rosa et al. evaluated the perceived Ease of Use and Perceived Usefulness of patterns for reducing process model complexity [81]. Recker et al. measured user perceptions on configurable reference process models based on MEM [79]. Hug et al. used MEM concepts for qualitative evaluation of a method for defining Information Systems engineering processes [82]. Target populations in these studies consist mainly of groups of students and modeler experts.

#### 4.1.3 Selection of Data-Centric Approaches

As observed in the previous chapter, a number of data-centric modeling approaches have appeared recently in several research environments. For practical reasons and due to time and scope constraints, only a limited number of modeling approaches are evaluated. Selection of methods was made according to the following criteria:

- 1) Selected methods should be renowned. This based on the relevance or *popularity* of methods in terms of number of citations in publications.
- 2) The selected methods should cover the distinct groups of methods identified in the theoretical evaluation (bridging, object lifecycle-based, data-driven execution). This in order to gain insights of methods with different conceptual principles.
- 3) Novelty of the methods. Methods should increase prominence of the data perspective. Due to this, the family of *object-oriented linking* or *bridging* methods was not considered in the selection since they still rely on traditional activity-centric modeling techniques for the specification of processes.

The relevance of methods was obtained from the citation count analysis performed for the methods selection in the non-empirical evaluation (c.f. Appendix B). The top five cited methods, without considering bridging methods are: case handling and product-based workflow design from the data-driven execution group and artifact-centric process models, object-lifecycle compliant processes and data-driven process structures from the object lifecycle data integration group. From these candidates the following ones were chosen because it was possible to inquire the promoter researchers directly: 1) Product-Based Workflow Design from Eindhoven University of Technology, 2) Artifact-Centric Business Process Models from IBM Watson Research Laboratory and 3) Data-driven process structures from University of Twente, University of Ulm and Daimler Chrysler AG.

Altogether, the three methods cover the distinct types of data-integration concepts defined in Section 3.4, namely object lifecycles, objects interactions and data-driven execution.

#### 4.1.4 Construction of Models

The knowledge construction model proposed by Gemino & Wand [83] is used as guideline for the development of the process models. This model suggests three antecedent elements of the construction of conceptual models:

- Content to be delivered. In this case the selection of the business process that will be modeled using the different data-centric approaches.
- Presentation of the content. The selection of the grammars and the way that models are presented.
- Persons participating in the communication. The characteristics of the persons participating in the evaluation.

#### 4.1.4.1 Case Selection

The contents to be delivered refer to the “type of information contained within the cases” [47]. Some business case descriptions focus on process elements while others focus on static data structures. Since data-centric approaches combine control-flow and data perspectives, the selected business case should contain elements from both perspectives and also should cover the conceptual elements of all the selected modeling methods. In addition, the focus groups of the evaluation are students and modeling professionals from a variety of industries; hence, the use of cases from a generic domain that can be easily understood by all participants is preferred over descriptions of specialized fields whose technicalities and jargon may affect the evaluation.

Considering these restrictions, a theoretical case description that covers both data and process perspectives was chosen. The theoretical business case developed by Van Nuffel in his PhD thesis [84] about a custom bikes shop provides a *non-specialized*, intuitive domain case that covers process and data elements and the core conceptual elements considered by the modeling approaches to be evaluated. Appendix D. Case Description presents the adapted case description used in the present research.

#### 4.1.4.2 Presentation of the content

The method of presentation refers to the way in which the process models are presented [47]. Dimensions considered in this respect include:

- The choice of notations.
- Rules regarding the use of grammar and how it is applied.
- The way the models are presented (e.g. text, graphics, and animations).

### **Choice of Notations**

A set of supporting modeling concepts, metamodels and notations have been developed for each data-centric modeling approaches. For some of them there is a unique grammar proposition (e.g. object-centric process models) while other methods have developed a wide variety of metamodels (e.g. IBM artifact-centric processes). The selected modeling notations and constructs are presented in Table 4.1 .

Approach	Considered Notation
Product-Based Workflow Design (PBWD)	The notation for product-data model shown in Section 3.3.3.1 and introduced in [9,72] is the de facto notation and the one considered for this approach.
Data-driven process structures	The data and process structures metamodel elements considered in Section 3.3.2.4 and introduced in [54] are the currently supported in the COREPRO framework and the ones considered for this research.
Artifact-centric process models	There exists a wide variety of metamodels underlying artifact information models. The selected approach is the basic form of the BALSAs framework (cf. Section 3.3.2.3) [5].

Table 4.1 Selection of Modeling Notations

The selection of modeling notations for PBWD and data-driven process structures is straight-forward since they have a dominant, well-defined metamodel and corresponding modeling notation. On the other hand, artifact-centric process models have developed a wide variety of process models representations ranging from procedural to declarative approaches. The BALSAs<sub>basic</sub> framework was chosen because: (1) it represents the basic form of specifying business operational models [5], (2) the declarative approach used for specifying the associations layer is conformant with IBM's current research trend for specifying artifact models based on declarative approaches [53] (e.g. Project Artifact<sup>5</sup>).

### Rules regarding the use of grammar

The references cited in Table 4.1 describe the rules for specifying process models and they are used as primary source for this matter. This is complemented with additional documentation and material (e.g. additional publications, screen casts) that demonstrate the correct use of the modeling constructs. Furthermore, when available design guidelines were followed for the model's construction (e.g. keeping preconditions as minimal as possible when defining services in the artifact centric approach [5]) and constructions were validated with modeling experts.

### Method of Presenting

The different modeling constructs are presented in the same way for the three different modeling approaches. The material supplied to the participants of the evaluation for each modeling method includes:

<sup>5</sup> [http://domino.research.ibm.com/comm/research\\_projects.nsf/pages/artifact.index.html](http://domino.research.ibm.com/comm/research_projects.nsf/pages/artifact.index.html)

- Description of the modeling approach. An overview of the methods and an example to illustrate the method's concepts and rules.
- Process Models. The models and constructions developed according to each method are provided. To emulate comparable tool support in their creation, all models are designed using the Microsoft Windows diagram program Visio following the graphical elements suggested by each method. A comparable use of colors and size of models was intended.

See Appendix E, F and G for the constructed models of PBWD, data-centric process models and artifact-centric process models respectively.

#### 4.1.4.3 Focus Groups

The third aspect is to consider the characteristics of the target population and the selection of participant pools. The population of interest should have knowledge of conceptual modeling techniques, particularly in business process modeling. One of the main issues in the use of questionnaires is the low response rate of recipients [11]; to counterpart this, college students are commonly addressed communities in evaluation of conceptual modeling topics [13,85,86]. Based on this, the first selected group corresponds to Business Information Systems master students of Eindhoven University of Technology in The Netherlands; this group is characterized by having a formal instruction in business process modeling and Information Systems related topics. To gain external validity, the second group of participants is formed by process modeling professionals; this group has practical experience in conceptual and process modeling techniques in a variety of industrial backgrounds.

#### 4.1.5 Questionnaire Design

Typically, questionnaires are employed to measure the Perceived Ease of Use and Perceived Usefulness of conceptual modeling techniques. In these questionnaires, each item (question or statement) is measured using a Likert scale, a rating scale used for measuring attitudes [87]. Recker & Rosemann [88] developed a measurement instrument for the study of acceptance of process modeling diagrams that can be used as guidelines of empirical studies in business process modeling. In this research, they identified candidate items for measuring Perceived Usefulness and Perceived Ease of Use that were ranked by a panel of modeling experts; the result is a set of top candidate items for measuring those theory constructs. Similarly, Maes & Poels [80] defined items for measuring the same theory constructs for conceptual modeling scripts. To secure content validity, the items included in the questionnaire are based on these instruments using a 7-point Likert scale ranging from *Strongly disagree* to *Strongly agree*. The



selected questions for each theory construct are shown in Table 4.2. This set of questions is used to evaluate each data-centric modeling approach. Questions are adapted to indicate the name of the modeling approach currently evaluated (e.g. Product-Based Workflow Design where the expression “*the method*” appears). Questions are presented to the participant in a random order to minimize the effect that could induce monotonous responses to questions measuring the same construct [13].

Theory Construct	Item Definition
Perceived Usefulness	<ul style="list-style-type: none"> <li>• I found <i>the method</i> easy to learn</li> <li>• I would find creating process specifications using <i>the method</i> to be easy.</li> <li>• I would find it easy to model processes in the way I intended using <i>the method</i>.</li> </ul>
Perceived Ease of Use	<ul style="list-style-type: none"> <li>• Overall, I find <i>the method</i> useful for specifying processes.</li> <li>• I believe that this method would reduce the effort to model business processes.</li> <li>• Overall, I think using the method would be an improvement over a textual description of the business process.</li> <li>• I find the method useful for the purpose of providing input to systems design.</li> </ul>

Table 4.2 Items per theory construct (adapted from [80,88])

#### 4.1.6 Data Collection Protocol

The evaluation was crafted using a web-based survey tool<sup>6</sup>. The survey was validated by an academic process modeling expert and announced via e-mail. An online survey is convenient since it eliminates time and geographical constraints. The survey consists of the following parts:

- An introductory text with an explanation and characteristics of the survey.
- A section with demographic questions.
- Case Description
- Presentation of Modeling Approach 1 (method description and process models).
- Questions about Perceived Ease of Use and Perceived Usefulness for method 1.
- Presentation of Modeling Approach 2 (method description and process models).
- Questions about Perceived Ease of Use and Perceived Usefulness for method 2.
- Form for providing comments and feedback.
- End of Survey.

<sup>6</sup> <http://www.surveygizmo.com/>

Each participant is provided with process models for two modeling approaches. This means that there are three versions of the survey for the evaluation of the three data-centric modeling approaches (i.e. PBWD & artifact-centric, PBWD & data-driven process structures, artifact-centric & data-driven process structures). This strategy was defined considering the limited amount of time available of the participants and to prevent tediousness in respondents. The complete survey is included in Appendix H. Data-Centric Modeling Approaches Survey.

#### 4.1.7 Results and Findings

In total, 15 persons responded to the survey. The following table highlights the main demographic characteristics of the addressed population. The statistics and analyses presented in this section were performed using the software SPSS Statistics.

Aspect	Values	Percentage
<b>Sex</b>	Male	60%
	Female	40%
<b>Region</b>	Europe	66.67%
	Latin America	20%
	Asia	13.33%
<b>Modeling Expertise</b>	Novice	6.67%
	Intermediate	86.67%
	Expert	6.67%
<b>Modeling Uses</b>	Documentation	46.66%
	Process Management	60%
	Process Guidance	26.66%
	Process Improvement	80%
	Process Automation	46.66%
<b>Position</b>	Student	60%
	Solution Architect	13.33%
	Software Engineer	6.67%
	Process Analyst	6.67%
	Academic	6.67%
	Other	6.67%
<b>Industry</b>	Information Technology	33.33%
	Telecommunications	33.33%
	Healthcare	33.33%
<b>Knowledge of methods</b>	Product-Based Workflow Design	46.66%
	Artifact-Centric Process Models	13.33%
	Data-driven process structures	0.0%

Figure 4.3 Population statistics

Before analyzing the results obtained for Perceived Ease of Use and Perceived Usefulness, it is necessary to evaluate the reliability of their empirical indicators. Reliability corresponds to the internal consistency of a measurement instrument; the most commonly used test is Cronbach's alpha [88]; Cronbach's alpha reliability

coefficient ranges between 0 and 1. As a rule of thumb, results are considered internally consistent when Cronbach’s alpha is greater than 0.7 [13]. Table 4.3 shows Cronbach’s alpha for the two measured constructs showing values above 0.7.

Construct	Cronbach’s $\alpha$
Perceived Ease of Use	0.927
Perceived Usefulness	0.850

Table 4.3 Constructs reliabilities

The box plots in Figure 4.4 show the outcomes of the data analysis for the two measured constructs in a boxplot format. A boxplot (or box-and-whisker diagram) shows the median as a horizontal line in the box formed by the lower and upper quartiles; it also shows the minimum and maximum values and indicates observations considered as outliers, i.e. those that are numerically distinct from the rest of the data. Rather than observing at absolute values, the analysis will focus on the relationships between variables since generalizations can be drawn more safely from them [13]. In the left part of Figure 4.4, the Perceived Ease of Use of the three modeling approaches can be observed. Data-driven process structures is considered the least easy to use method; artifact-centric and product-based process models have similar medians for this construct. The relatively large size of the artifact-centric box indicates more dispersed observations. It can also be observed that most observations of data-driven process structures are on the low end of the scale. As observed in the right part of Figure 4.4, the three modeling methods are perceived to be useful (median 4.0 or higher); their median values are proximate to each other.

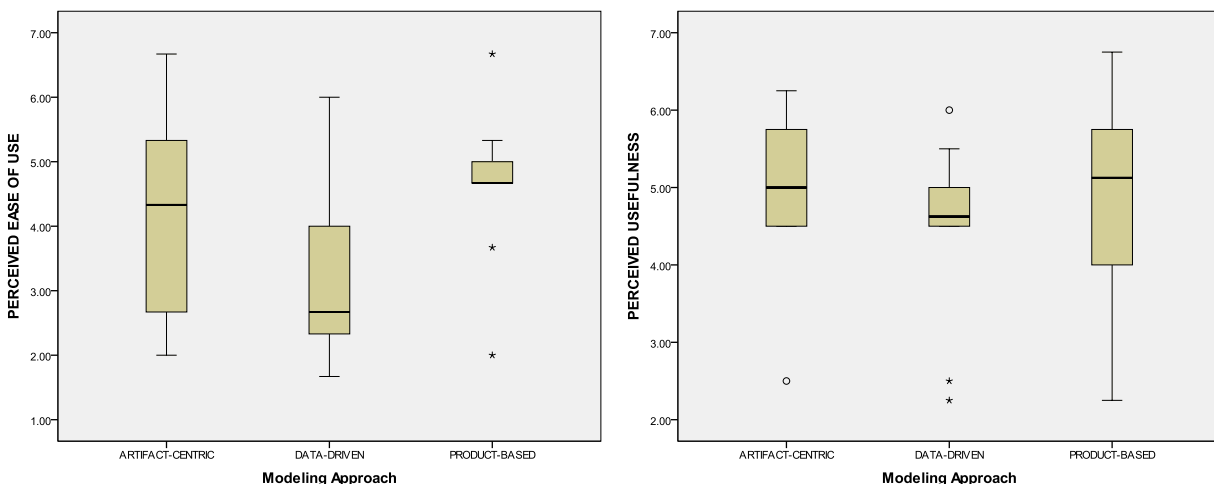

Figure 4.4 Perceived Ease of Use and Perceived Usefulness of modeling approaches

The evaluation targeted two populations with different characteristics and modeling expertise, namely students and process modeling professionals (nine and six participants respectively). Separate group analyses were performed to observe if the same tendencies are maintained across groups. The results obtained are shown in Figure 4.5. Regarding Perceived Ease of Use, the same general tendency is maintained across both groups: data-driven process modeling is rated lower compared with the other two methods which maintain proximate medians. Similarly, all methods have similar median rates of Perceived Usefulness across both groups (although data-driven median is evaluated slightly lower by the group of students).

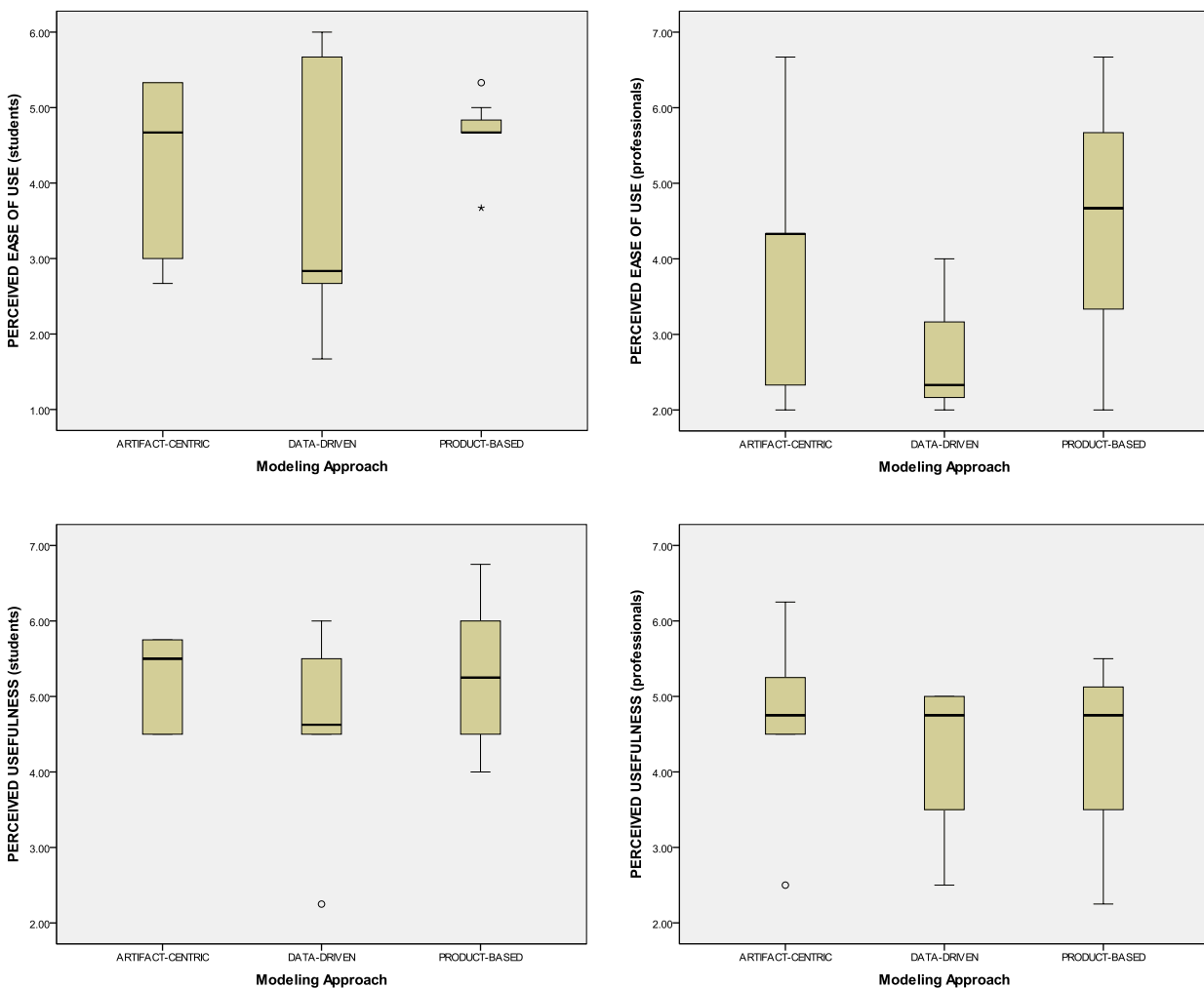

Figure 4.5 Perceived Ease of Use and Perceived Usefulness per groups of participants

Notice that, in general, modeling experts give lower rates than students. This may be explained by studies that show that when people are uncertain about their judgments because of their lack of experience or information, they are not likely to make extreme choices and they tend to centralize their responses [13].

Regarding potential bias due to previous education in some of the methods, the same analysis was conducted considering only participants (ten) without any knowledge of the methods they evaluated (cf. Figure 4.6). The same trend is maintained for the Perceived Ease of Use i.e. data-centric process models is considered the least easy to use method, followed by artifact-centric and product-based design with similar median values. Nevertheless, a change is observed with respect of the Perceived Usefulness. From having comparable median values, now the most perceived useful method is artifact-centric, followed by data-driven process structures and finally product-based workflow design.

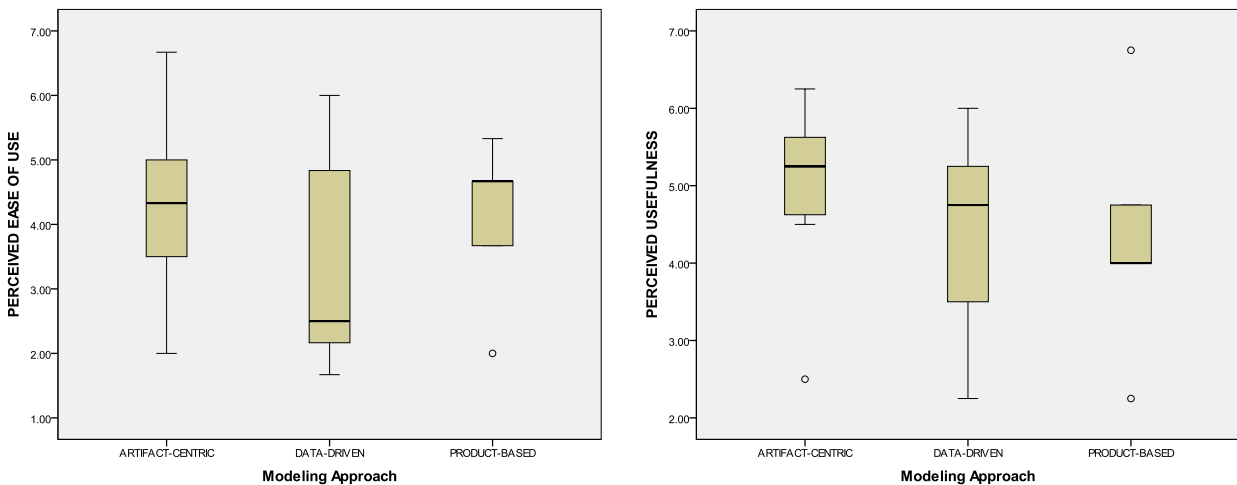

Figure 4.6 Perceived Ease of Use and Perceived Usefulness of participants without previous knowledge

#### 4.1.8 Limitations

The focus of observation of the empirical study was to gain initial insights on the Perceived Ease of Use and Perceived Usefulness of the modeling approaches. The results should be treated with caution and it should be considered within the limitations of the study. First, a common observation in studies comparing modeling methods and techniques is that results are sensitive to the type of case being used [47]. Although the business process case employed is generic in the sense that it does not demand specialized knowledge of a particular domain, results obtained from two or more cases of other domains would lead to stronger validity of the results. Second, the validity of the results could be increased by extending the sample size of participants. Further, most of the participants in the study were students; to increase external validity, the number of practitioners from different domains should be increased. Third, in this study participants received a limited amount of material to get acquainted with the methods. A further study should include formal training of the participants and the evaluation should take place in a more controlled environment, e.g. in a laboratory experiment. Especially for some methods, practice has shown that their true value and overall concepts are

agreed and understood after intensive workshops and group sessions with stakeholders [66]. Finally, it should also be considered the effect of previous knowledge and education of participants in some of the evaluated modeling approaches.

## 4.2 Practitioners' Case Studies

Behavioral variables of the MEM are measured through the Actual Effectiveness, Actual Efficiency and Actual Usage concepts. Approaches for obtaining actual usage include (1) field studies to examine the types of methodologies and the frequency in which they are used in industrial settings, and (2) the analysis of practitioner's descriptions with the experiences and results obtained using a particular methodology [12]. Capturing substantial and detailed data of adoption in practice to support this type of analysis may be an arduous and costly endeavor. As an alternative, the second approach based on practitioner's reports is taken to provide an overview of the reported benefits and usage scenarios of the data-centric modeling methods. Certainly, there is an inherent bias in reporting only successful cases from practitioners, but a general trend of benefits could be outlined when there is a substantial number of reported cases [12].

Table 4.4 depicts the industries where a certain modeling approach has been applied and their resulting benefits. Generally, it is observed that the reported benefits of the methods' practical applications comply with the drives and motivations behind each one (cf. Section 3.5). As expected, mostly only positive experiences were found in the studied publications.

<b>Modeling Approach</b>	<b>Industry</b>	<b>Case and Benefits</b>
Product-Based Workflow Design [72,71]	Financial	Redesign of an annual reporting process: <ul style="list-style-type: none"> <li>• 50% reduction of average throughput time</li> <li>• 60% fall of handovers</li> <li>• 18% reduction of control steps</li> </ul>
	Social Services	Redesign of a process for awarding unemployment benefits: <ul style="list-style-type: none"> <li>• 73% reduction of average throughput time</li> <li>• 10% of cases became fully automated</li> </ul>
Object-centric process models [38]	Social Services	Demonstrated patterns of flexibility of a social assistance process in a charity organization.

Modeling Approach	Industry	Case and Benefits
Data-driven process structures [54]	Automotive	Release Management process for electrical systems: <ul style="list-style-type: none"> <li>Modeling efforts reduced by more than 90%</li> <li>Mechanisms for easier maintenance of process models</li> </ul>
Case-Handling [39]	Social Services	Complaint and appeals department. Support of complex processes with many exceptions. No specific benefits are reported. Other application domains include: telecommunications, banks, government, real estate, education, security and IT companies.
Artifact-centric process models	Pharmaceutical [63]	Drug discovery process <ul style="list-style-type: none"> <li>Change management applied hierarchically from strategic layer down to implementation layer.</li> </ul>
	Financial [66]	IBM Global Financing processes <ul style="list-style-type: none"> <li>Definition of a global business operations model integrating knowledge “silos” and supporting local geographic variations</li> <li>Initial skepticism to the method required intensive workshops with executives</li> </ul>
	Financial [67]	Consolidation of processes of a health insurance company for providers management <ul style="list-style-type: none"> <li>Specifications of general processes allowing local variations</li> </ul> <p>Counter examples of the approach not providing significant value are where the primary concern is improvement at the level of functional-implementation details</p>
Object-compliant process models [55]	Financial	IBM Insurance Application Architecture <ul style="list-style-type: none"> <li>Validated conformance of business process models and object lifecycles</li> <li>Generation of new process models from object lifecycles</li> </ul>

Note: For WASA2, document-centric workflows and Trigsflow no relevant industry case studies were found in literature.

**Table 4.4 Real usage scenarios**

The application of the methods is usually triggered by the problems identified with traditional activity-centric process modeling (c.f. Section 2.3.2.1). For instance, the need to consolidate processes in a global standard supporting local geographic process variations motivated the application of the artifact-centric approach in IBM Global

Financing. Naturally, achieving the methods' intended objectives also triggers their application, like the demand for process flexibility of a charity organization and the application of object-centric process models [38]. From the reported cases, it can also be noticed that the scenarios where applied correspond to less structured, knowledge-intensive processes like those on financial and social services sector.

Table 4.5 presents another view of the relation between the intended benefits and the reported in practice descriptions. An unreported benefit does not have to be interpreted as it has not been achieved, but that the reviewed practice descriptions do not explicitly mention as one of the obtained benefits.

	<b>Process Compliance</b>	<b>Process optimization</b>	<b>Comm. and understanding</b>	<b>Reusability</b>	<b>Increased flexibility</b>	<b>Context tunneling avoidance</b>
Product-Based Workflow Design	-	+	-	-	o	-
Object-centric process models	-	-	-	-	+	-
Data-driven process structures	-	-	-	+	+	-
Artifact-centric process models	-	-	+	+	+	-
Object-lifecycle compliant process models	+	-	-	-	-	-

+: drive reported in practice descriptions      o: intended drive is not reported      -: not applicable drive

**Table 4.5 Drives in practical applications**

Although useful, decisive conclusions cannot be derived from this information since, as mentioned before, 1) there is an inherent bias to reporting only successful cases, 2) the number of reported cases is not substantial to determine a definite trend of the benefits due to the application of the methods. Furthermore, it is reasonable to expect that no one method will be appropriate for all scenarios and all applications.



---

## 5 Conclusions

This section concludes the study by elaborating on the research questions and providing directions for future research.

### ***First research question***

The first research question refers to the common and distinct features of the various data-centric modeling approaches. A number of features were selected from the literature review and methods were evaluated across them. The constructed framework helps in visualizing the *conceptual proximity* of the methods; it shows that differences between some methods are not fundamental and that some extensions and/or change of perspectives can expand the benefits, serving as a guide towards more robust approaches. The important aspect of process flexibility was emphasized in the evaluation.

### ***Second research question***

Rather than just developing more robust and technically superior methods, the success of a method is determined by its adoption in practice. This evaluation precisely addresses that issue by giving initial insights on the factors that determine the willingness of practitioners to use the studied methods. The Technology Acceptance Model and in particular its adaptation to modeling methods, the Method Evaluation Model, suggests that a method that is perceived as useful and easy to use would be likely to be adopted by potential users. The empirical evaluation in this study measured the Perceived Ease of Use and Perceived Usefulness from the scripts creation perspective; this is, from a modeler's perspective. In general, the evaluated methods are perceived as comparably useful by the sample population. On the other hand, observations indicate that respondents perceive one of the studied methods as less easy to use than the others. These trends are maintained across the different target groups.

### ***Third research question***

The third research question refers to the actual usage of the modeling approaches. The analyzed methods are in distinct phases of development and of adoption in practice. To gain initial insights of their use in real scenarios, an analysis based on practitioner's case studies was performed. Although the amount of data available may be considered limited and biased, we can derive from the reported experiences that the methods analyzed achieve their intended objectives in practice. Furthermore, for some of them, proponents recognize the drawbacks and scenarios were the application of the methods

has not provided significant value. This knowledge is valuable for methods selection according to the desired objectives.

### ***Future research***

The area of process modeling approaches that give data perspective a more prominent role is an evolving and promising research direction. Given the current tendency, it is expected that more research initiatives will derive in an increased number of methods and more extended adoption in practice. Regarding the evaluation of methods, some research lines can be envisioned. From the theoretical perspective, other features could be detected and used to expand and improve the proposed framework as well as to evaluate other methods. Moreover, other non-empirical evaluation techniques addressing other elements can be applied. These analyses will allow identifying the requirements and possibilities towards the definition of the new generation of modeling approaches. The present study provides initial insights on the empirical evaluation of methods; more controlled studies with formal training should be applied to increase the validity of the findings; also, the studies could be performed with a larger number of practitioners to gain external validity across several business domains.

There are many other aspects of data-centric approaches that demand further investigation. For instance, an evaluation of the variations of the artifact-centric paradigm is worth of a dedicated research. Also, the implications of these methods in other areas such as process mining are an interesting area to explore. Finally, further studies that analyze systematically the benefits obtained and the costs incurred when applying the methods in practice would provide insights on which approaches should be used in specific situations.

## References

1. Hammer, M., Champy, J.: Reengineering the corporation : a manifesto for business revolution 1st edn. Harper Business, New York (1993)
2. Davenport, T. H.: Process Innovation: Reengineering Work through Information Technology. Harvard Business School Press, Boston, Massachusetts (1993)
3. Davenport, T., Short, J.: The New Industrial Engineering: Information Technology and Business Process Redesign. Sloan Management Review, 11-27 (1990)
4. Ould, M.: Business Process Management: A Rigorous Approach 1st edn. The British Computer Society (2005)
5. Bhattacharya, K., Hull, R., Jianwen, S.: A data-centric design methodology for business processes. In : Handbook of Research on Business Process Modeling. Information Science Reference, London (2009) 503-531
6. Kumaran, S., Liu, R., Wu, F.: On the Duality of Information-Centric and Activity-Centric Models of Business Processes. Lecture Notes in Computer Science, 32-47 (2008)
7. van der Aalst, W. M. P., Berens, P. J. S.: Beyond workflow management: product-driven case handling. In : Proceedings of the 2001 International ACM SIGGROUP Conference on Supporting Group Work, New York (2001)
8. Batthacharya, K., Gerede, C., Su, J.: Static Analysis of Business Artifact-centric Operational Models. In : SOCA '07 Proceedings of the IEEE International Conference on Service-Oriented Computing and Applications, pp.133-140 (2007)
9. Reijers, H., Limam, S., van der Aalst, W.: Product-Based Workflow Design. Journal of Management Information Systems 20(1), 229-262 (2003)
10. Muller, D., Herbst, J., Hammori, M., Reichert, M.: IT Support for Release Management Processes in the Automotive Industry. In : Proc. of International Conf. on Business Process Management, pp.368-377 (2006)
11. Siau, K., Rossi, M.: Evaluation of Information Modeling Methods - A Review. In : Proceedings of the 31st. Hawaii International Conference on System Sciences, Kohala Coast, vol. 5, pp.314-322 (1998)

12. Wynekoop, J., Russo, N.: Studying system development methodologies: an examination of research methods. *Information Systems Journal* 7(1), 47-65 (1997)
13. Moody, D.: The method evaluation model: a theoretical model for validating information systems design methods. (2003)
14. Davis, F.: A technology acceptance model for empirically testing new end-user information systems: theory and results. Sloan School of Management, Massachusetts Institute of Technology (1986)
15. Bandara, W.: Process Modelling Success Factor and Measures. PhD Thesis, Queensland University of Technology, Brisbane, Australia (2007)
16. Reijers, H., Vanderfeesten, I., van der Aalst, W.: Case Handling Systems as Product Based Workflow Design Support. *Lecture Notes in Business Information Processing* 12(4), 187-198 (2009)
17. Muller, D., Reichert, M., Herbst, J., Poppa, F.: Data-driven design of engineering processes with COREPROModeler., pp.376--378 (2007)
18. Künzle, V., Reichert, M.: PHILharmonicFlows: towards a framework for object-aware process management. *Journal of Software Maintenance and Evolution: Research and Practice* (2011)
19. Henriques, R., Silva, A.: Object-Centered Process Modeling: Principles to Model Data-Intensive Systems., pp.683-694 (2010)
20. Havey, M.: *Essential Business Process Modeling*. O'Reilly Media (2005)
21. Hammer, M.: What is Business Process Management? In Rosemman, M., vom Brocke, J., eds. : *Handbook on Business Process Management 1* 1st edn. Springer (2010)
22. Workflow Management Coalition: Terminology & Glossary. In: Workflow Management Coalition. (Accessed 2011) Available at: [http://www.wfmc.org/standards/docs/TC-1011\\_term\\_glossary\\_v3.pdf](http://www.wfmc.org/standards/docs/TC-1011_term_glossary_v3.pdf)
23. Weske, M.: *Business Process Management: Concepts, Languages, Architectures*. Springer-Verlag (2007)
24. Krogstie, J., Aagesen, G.: Analysis and Design of Business Processes Using BPMN. In Rosemann, M., von Brocke, J., eds. : *Handbook on Business Process*

- Management 1 1st edn. II. Springer (2010)
25. Rodriguez-Priego, E., Garc a-Izquierdo, F., Rubio,  .: Modeling issues: a survival guide for a non-expert modeler. *Model Driven Engineering Languages and Systems*, 361--375 (2010)
  26. van der Aalst, W., ter Hofstede, A., Weske, M.: Business process management: A survey. *Business Process Management*, 1019--1019 (2003)
  27. Seidewitz, E.: What models mean. *Software, IEEE* 20, 26--32 (2003)
  28. Curtis, B., Kellner, M., Over, J.: Process Modeling. *Communications of the ACM* 35(9), 75-90 (1992)
  29. Krogstie, J.: Process Modeling Value Framework. In : *Enterprise Information Systems*. Springer Berlin Heidelberg (2008)
  30. Aguilar-Saven, R.: Business process modelling: Review and framework. *International Journal of Production Economics* 90(2), 129-149 (2004)
  31. Rosemann, M., Recker, J., Green, P., Indulska, M.: Business process modeling : perceived benefits. In : *Proceedings of the 28th International Conference on Conceptual Modeling*, pp.458-471 (2009)
  32. Giaglis, G.: A Taxonomy of Business Process Modeling and Information Systems Modeling Techniques. *The International Journal of Flexible Manufacturing Systems* 13, 209-228 (2001)
  33. Kettinger, W., Teng, J., Guha, S.: Business Process Change: A Study of Methodologies, Techniques, and Tools. *MIS Quarterly* 21(1), 55-80 (1997)
  34. Luo, W., Tung, Y.: A Framework for Selecting Business Process Modeling Methods. *Industrial Management & Data Systems*, 312-319 (1999)
  35. Wang, J., Kumar, A.: A Framework for Document-Driven Workflow Systems. *Lecture Notes in Computer Science*, 285-301 (2005)
  36. Workflow Patterns home page. In: Workflow Patterns Initiative. Available at: <http://www.workflowpatterns.com/>
  37. Browne, E. D., Schrefl, M., Warren, J. R.: A Two Tier, Goal-Driven Workflow Model for the Healthcare Domain. In : *Proceedings of the 5th International Conference on*

- 
- Enterprise Information Systems, vol. III, pp.32-39 (2003)
38. Redding, G., Dumas, M., Hofstede, A., Iordachescu, A.: A flexible, object-centric approach for business process modelling. *Service Oriented Computing and Applications* 4(3) (2010)
  39. van der Aalst, W. M. P., Wekx, M.: Case handling: a new paradigm for business process support. *Data & Knowledge Engineering* 53(2) (2005)
  40. Müller, D., Reichert, M. U., Herbst, J.: Flexibility of Data-driven Process Structures. In : *BPM 2006 International Workshops* (2006)
  41. Hull, R., Fritz, C., Su, J.: Automatic construction of simple artifact-based business processes. In : *Proceedings of the 12th International Conference on Database Theory*, pp.225-238 (2009)
  42. Bhattacharya, K., Liu, R., Wu, F.: Modeling Business Contexture and Behavior Using Business Artifacts. In : *19th International Conference Advanced Information Systems Engineering* (2007)
  43. Mulyar, N. A., Schonenberg, M. H., Mans, R. S., Russell, N. C., van der Aalst, W. M. P.: Towards a Taxonomy of Process Flexibility (Extended Version). *BPM Center Report*, BPMCenter.org (2007)
  44. Kueng, P., Kawalek, P.: Goal-based business process models: creation and evaluation. *Business Process Management Journal* 3, 17--38 (1997)
  45. Grando, A., Peleg, M., Glaspool, D.: A goal-oriented framework for specifying clinical guidelines and handling medical errors. *Journal of Biomedical Informatics*(43), 287-299 (2010)
  46. In: Swiss Informatics Group for Modelling. (Accessed 2008) Available at: [www.sigmo.ch/fileadmin/sigmo/documents/081112\\_BPMN-Overview.pdf](http://www.sigmo.ch/fileadmin/sigmo/documents/081112_BPMN-Overview.pdf)
  47. Gemino, A., Wand, Y.: A framework for empirical evaluation of conceptual modeling techniques. *Requirements Engineering* 9(4), 248-260 (2004)
  48. Lu, R., Sadiq, S.: A survey of comparative business process modeling approaches. In : *Proceedings of the 10th international conference on Business information systems*, pp.82-94 (2007)
  49. Mingers, J.: Combining IS research methods: towards a pluralist methodology.

- 
- Information Systems Research 12, 240--259 (2001)
50. Vossen, G., Weske, M.: The WASA2 object-oriented workflow management system., vol. 28, pp.587--589 (1999)
  51. Kappel, G., Lang, P., Rausch-Schott, S., Retschitzegger, W.: Workflow management based on objects, rules, and roles. Data Engineering Bulletin 18, 11--18 (1995)
  52. Nigam, A., Caswell, N.: Business artifacts: An approach to operational specification. IBM Systems Journal 42, 428--445 (2003)
  53. Hull, R.: Artifact-centric business process models: Brief survey of research results and challenges. On the Move to Meaningful Internet Systems: OTM 2008, 1152--1163 (2008)
  54. Muller, D., Reichert, M., Herbst, J.: Data-driven Modeling and Coordination of Large Process Structures. In : Proc. of International Conf. on Cooperative Information Systems, pp.131-149 (2007)
  55. Küster, J., Ryndina, K., Gall, H.: Generation of business process models for object life cycle compliance. Business Process Management, 165--181 (2007)
  56. Patton, M.: Qualitative evaluation and research methods. SAGE Publications, inc (1990)
  57. Wirtz, G., Weske, M., Giese, H.: The OCoN approach to workflow modeling in object-oriented systems. Information Systems Frontiers 3, 357--376 (2001)
  58. Redding, G., Dumas, M., Hofstede, A., Iordachescu, A.: Generating business process models from object behavior models. Information Systems Management 25, 319--331 (2008)
  59. Snoeck, M.: Separating business process aspects from business object behaviour. New directions in software engineering, by L. Amicorum, M. Verhelst, J. Vandernbulcke (Edt.), and M. Snoeck (Edt.)
  60. Snoeck, M., Dedene, G., Verhelst, M., Depuydt, A.: Object-oriented enterprise modelling with MERODE. Leuven University Press (1999)
  61. Snoeck, M., Poelmans, S., Dedene, G.: An architecture for bridging OO and business process modelling., pp.132--143 (2000)

62. Kappel, G., Rausch-Schott, S., Retschitzegger, W.: A framework for workflow management systems based on objects, rules and roles. *ACM Computing Surveys (CSUR)* 32, 27 (2000)
63. Bhattacharya, K., Guttman, R., Lyman, K., Heath III, F., Kumaran, S., Nandi, P., Wu, F., Athma, P., Freiberg, C., Johannsen, L.: A model-driven approach to industrializing discovery processes in pharmaceutical research. *IBM Systems Journal* 44, 145--162 (2005)
64. Cohn, D., Hull, R.: Business artifacts: A data-centric approach to modeling business operations and processes. *IEEE Data Eng. Bull* 32, 3--9 (2009)
65. van der Aalst, W.: *Flexible Workflow Management Systems: An Approach Based on Generic Process Models.*, vol. 10, p.186 (1999)
66. Chao, T., Cohn, D., Flatgard, A., Hahn, S., Linehan, M., Nandi, P., Nigam, A., Pinel, F., Vergo, J., Wu, F.: Artifact-based transformation of ibm global financing. *Business Process Management*, 261--277 (2009)
67. Bhattacharya, K., Caswell, N., Kumaran, S., Nigam, A., Wu, F.: Artifact-centered operational modeling: lessons from customer engagements. *IBM Systems Journal* 46, 703--721 (2007)
68. Bhattacharya, K., Gereade, C., Hull, R., Liu, R., Su, J.: Towards formal analysis of artifact-centric business process models. *Business Process Management*, 288--304 (2007)
69. Liu, R., Bhattacharya, K., Wu, F.: Modeling business contexture and behavior using business artifacts., pp.324--339 (2007)
70. Kamphuis, J., Vanderfeesten, I., Reijers, H., van Hattem, M.: From product data model to process model. *techreport* (2008)
71. Reijers, H., Vogelaar, J., Vanderfeesten, I.: Changing products, changing processes: dealing with small updates in product-based design., pp.56--61 (2010)
72. Vanderfeesten, I., Reijers, H., van der Aalst, W.: Product Based Workflow Support: A Recommendation Service for Dynamic Workflow Execution. *Design* 5074, 571--574 (2008)
73. Reijers, H., Rigter, J., van der Aalst, W.: The case handling case. *International Journal of Cooperative Information Systems* 12, 365--392 (2003)



- 
74. Krishnan, R., Munaga, L., Karlapalem, K.: XDoC-WFMS: A Framework for Document Centric Workflow Management System. *Conceptual Modeling for New Information Systems Technologies*, 348--362 (2002)
  75. Müller, D.: Management datengetriebener Prozessstrukturen. PhD Thesis, Ulm University (2009)
  76. Vanderfeesten, I., Reijers, H., van der Aalst, W.: Case Handling Systems as Product Based Workflow Design Support., vol. 12, p.187 (2008)
  77. Mangan, P., Sadiq, S.: On building workflow models for flexible processes. (2002)
  78. Weber, B., Rinderle, S., Reichert, M.: Change support in process-aware information systems-a pattern-based analysis. *Data Knowl. Eng* 66, 438--466 (2008)
  79. Recker, J., Rosemann, M., van der Aalst, W.: On the User Perception of Configurable Reference Process Models--Initial Insights. (2005)
  80. Maes, A., Poels, G.: Evaluating quality of conceptual modelling scripts based on user perceptions. *Data & Knowledge Engineering* 63, 701--724 (2007)
  81. La Rosa, M., ter Hofstede, A., Wohed, P., Reijers, H., Mendling, J., van der Aalst, W.: Managing process model complexity via concrete syntax modifications. *Industrial Informatics, IEEE Transactions on*, 1--1 (2011)
  82. Hug, C., Mandran, N., Rieu, D.: Qualitative evaluation of a method for information systems engineering processes., pp.257--268
  83. Gemino, A., Wand, Y.: Evaluating modeling techniques based on models of learning. *Communications of the ACM* 46, 79--84 (2003)
  84. van Neuffel, D.: Towards designing modular and evolvable business processes. PhD Thesis, Universiteit Antwerpen, Antwerpen (2011)
  85. Recker, J., Rosemann, M., van der Aalst, W.: On the User Perception of Configurable Reference Process Models--Initial Insights. (2005)
  86. Danesh, A., Kock, N.: An experimental study of process representation approaches and their impact on perceived modeling quality and redesign success. *Business Process Management Journal* 11, 724--735 (2005)

- 
87. Lewis-Beck, M., Bryman, A., Liao, T.: The Sage encyclopedia of social science research methods 1. Sage Publications, Inc (2004)
  88. Recker, J., Rosemann, M.: A measurement instrument for process modeling research: development, test and procedural model. *Scandinavian Journal of Information Systems* 22, 1 (2010)
  89. Marchetti, A., Tesconi, M., Minutoli, S.: Xflow: An xml-based document-centric workflow. *Web Information Systems Engineering--WISE 2005*, 290--303 (2005)
  90. Artifact-Centric Service Interoperation Project. In: ACSI Project. (Accessed 2011) Available at: <http://www.acsi-project.eu/papers/DoWPartB-tech.pdf>
  91. Kappel, G., Prdl, B., Rausch-Schott, S., Retschitzegger, W.: *TriGS, Active Object-Oriented Workflow Management.*, vol. 1060 (1995)
  92. Smith, H., Fingar, P.: *Business Process Management: The Third Wave* 1st edn. Meghan-Kiffer Press, Tampa, Florida (2002)
  93. Zlatkin, S., Kascheck, R., Pavlov, R., Shekhovtsov, V.: Towards Selecting Among Business Process Modeling Methodologies. In Abramowicz, W., Mayr, H., eds. : 9th International Conference on Business Information Systems (BIS 2006), Klagenfurt, Austria, pp.28-26 (2006)
  94. Hommes, B.-J., Van Reijswoud, V.: Assessing the Quality of Business Process Modeling Techniques. In : 33rd Hawaii International Conference on System Sciences, vol. 1 (2000)
  95. Rossi, M., Brinkkemper, S.: Complexity Metrics for Systems Development Methods and Techniques. *Information Systems* 21(2), 209-227 (1996)
  96. Reijers, H. A., Mendling, J., van der Aalst, W. M. P.: Seven process modeling guidelines (7PMG). *Information and Software Technology* 52(2), 127-136 (2010)
  97. Krogstie, J., Sindre, G., Jorgensen, H.: Process models representing knowledge for action: a revised quality framework. *European Journal of Information Systems*(15), 91-102 (2006)
  98. Rosemann, M., Becker, J., von Uthmann, C.: *Guidelines of Business Process Modeling*. In : *Business Process Management: Models, Techniques, and Empirical Studies*. Springer Berlin / Heidelberg (2000)

99. Kueng, P., Bichler, P., Kawalek, P., Schrefl, M.: How to compose an object-oriented business process model. Proceedings of the IFIP TC8, WG8 1, 94--110
100. Browne, E., Schrefl, M., Warren, J.: Goal-focused self-modifying workflow in the healthcare domain. In : Proceedings of the 37th Annual Hawaii International Conference on System Sciences (2004)
101. Van der Aalst, W., Weske, M., Grunbauer, D.: Case handling: a new paradigm for business process support. Data & Knowledge Engineering 53, 129--162 (2005)

## Appendix A. Reference Conceptual Map

The following reference conceptual map is provided as a summary of the business process modeling concepts covered in Chapter 2. The elements, objectives and approaches of process modeling are illustrated as well as the reference documents where they are stated.

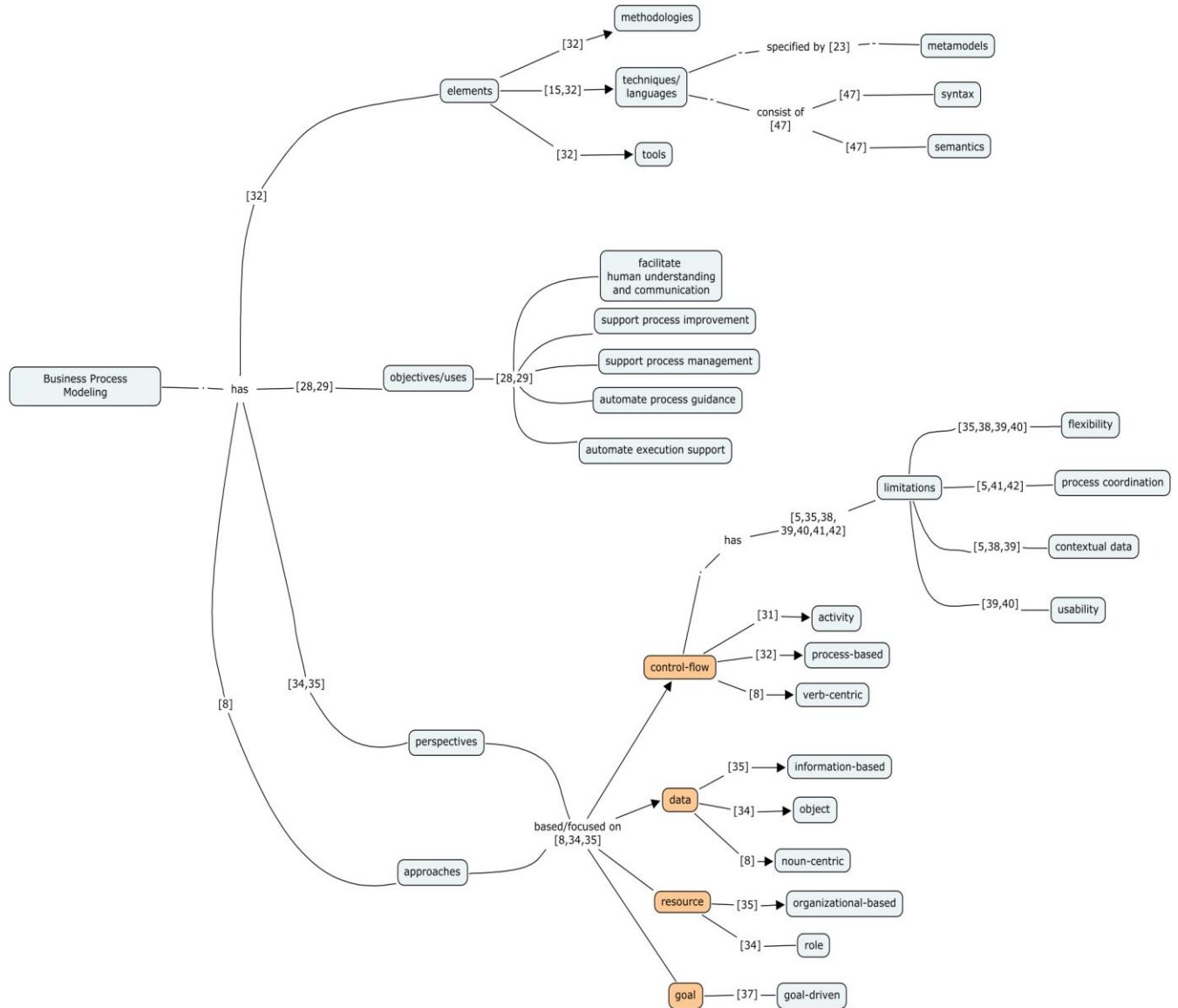

Figure A.1 Business Process Modeling Reference Conceptual Map

## Appendix B. Methods Selection

The following table shows the promoters and citation count of the main publication for each method.

	<b>Modeling approach</b>		<b>Main/seminal publication</b>	<b>Promoters</b>	<b>Citations</b>	<b>Tool Support</b>
Data-driven	Product-Based Workflow Design	2003	[9]	Eindhoven University of Technology	91	<ul style="list-style-type: none"> <li>• ExSpect toolbox</li> </ul>
	Case Handling	2005	[39]	Eindhoven University of Technology, Pallas Athena	268	<ul style="list-style-type: none"> <li>• Pallas Athena FLOWer</li> <li>• Staffware</li> <li>• Case Handler</li> <li>• COSA</li> <li>• Activity Manager</li> <li>• Vectus</li> </ul>
Object lifecycle	Artifact-Centric Process Models	2003	[52]	IBM Watson Research Laboratory	144	<ul style="list-style-type: none"> <li>• BELA's Fastpath tool</li> <li>• IBM WebSphere Process Server</li> <li>• Siena Prototype</li> </ul>
	Object-lifecycle compliance processes	2007	[55]	IBM Zurich Research Laboratory, University of Zurich	74	<ul style="list-style-type: none"> <li>• As extension of IBM WebSphere Business Modeler</li> </ul>
	Data-driven modeling and coordination of large process structures	2007	[54]	University of Ulm, University of Twente, Daimler Chrysler AG	47	<ul style="list-style-type: none"> <li>• COREPRO modeler</li> </ul>
	Object-centric business process models	2010	[38]	Queensland University of Technology, FlowConnect	7	<ul style="list-style-type: none"> <li>• FlexConnect</li> </ul>
	PHILharmonicFlows	2011	[18]	University of Ulm, Persis GmbH	6	<ul style="list-style-type: none"> <li>• Prototype</li> </ul>
Document-based	Document-driven workflow systems	2005	[35]	Pennsylvania State University	43	<ul style="list-style-type: none"> <li>• Prototype</li> </ul>
	XDoC-WFMS: A Framework for Document Centric Workflow Management System	2002	[74]	International Institute of Information Technology (India)	14	<ul style="list-style-type: none"> <li>• Information not available</li> </ul>
	XFlow: an XML-Based document-Centric Workflow	2005	[89]	Consiglio Nazionale delle Ricerche IIT	10	<ul style="list-style-type: none"> <li>• Prototype</li> </ul>
Bridging methods	WASA <sub>2</sub> [54]	1999	[50]	University of Münster	49	<ul style="list-style-type: none"> <li>• Prototype</li> </ul>
	TriGSflow (active object oriented)	2000	[62]	University of Linz	116	<ul style="list-style-type: none"> <li>• Prototype</li> </ul>

	workflow management)					
	Object Coordination Nets	2001	[57]	Westfälische Wilhelms-Universität, Technical University Universität-Gesamthochschule-Paderborn	31	• Prototype

**Table B.1 Citations Count**

Citations count median value: 47.

Statistics obtained at the beginning of the second quarter of 2011.

## Appendix C. Methods Drives and Motivations

The table below presents only a few extracts of publications where motivations of each method are explicitly stated and from where drives were inferred.

<b>Data-driven</b>	<p><b>Reusability:</b> “Our goal is to reduce modeling efforts for data-driven process structures by increasing model reusability and maintainability”. [54]</p> <p><b>Flexibility by change:</b> “In practice, data changes and process changes occur frequently. Flexibility and dynamic adaptation support are therefore not only required at the level of single process executions, but also at the process structure level” [54]. “Our approach enables a more flexible method for process modeling”. [40]</p> <p><b>Flexibility by underspecification: inferred</b> from the fact that the procedures or sub-processes modifying the different objects might differ; the method coordinated them but does not constrain the contents of each sub-process.</p>
<b>Artifact-centric</b>	<p><b>Reusability:</b> “At the philosophic level, business objects are intended to be re-usable across several or many enterprises, and focus on relatively small-grained collections of functionality“. [90]</p> <p><b>Reusability:</b> “..., to enable re-use and workflow composition (automated if possible). Analogous to the goals of semantic web services, it should be possible to establish a library of business process components which are easy to refine and compose together” [53]</p> <p><b>Flexibility by underspecification:</b> “The emerging challenge of generic/specialized is focused on the need to permit the specification of a generic workflow schema that can have multiple specializations, for use in different circumstances” [53]. “... additional conditions governing when an artifact can pass from one stage to another can be incorporated at the level of associations. This provides rich flexibility in terms of specializing the basic artifact lifecycle to fit with a variety of contexts” [5].</p> <p><b>Communication and Understanding:</b> “The artifact-centric approach enables rich, natural communication among diverse stakeholders about the operations and processes of a business, in ways that activity-flow based and document-based approaches have not.” [64]</p>
<b>Object-lifecycle compliant processes</b>	<p><b>Process compliance:</b> “Objects used in business process models are commonly standardized using reference models... The proposed approach is to use the reference object life cycles to generate an initial business process model that is compliant with these life cycles by construction.” [55]</p>
<b>Document-driven workflows</b>	<p><b>Flexibility by design:</b> “Document-driven workflow systems are more flexible than traditional control flow processes” [35]. Approaches based on control flow “cannot predict the upper boundary of the flexibility. In the document-driven architecture, this upper boundary is obviously the dependency between documents. The document-driven design can easily discover the hard dependencies and provides the upper boundary of flexibility”. [35]</p> <p><b>Flexibility by change:</b> “The process is very flexible and can be changed instantly by changing constraints” [35].</p>

<p><b>Object-centric process models</b></p>	<p><b>Flexibility patterns (design, underspecification, deviation):</b> “In our experience in applying object-oriented approaches to design process-aware systems that need to deal with ad-hoc situations, a range of requirements have been observed that are condensed into <i>three patterns of flexibility</i>... For example, delegation is a form of flexibility by design, creation is a form of flexibility by deviation, and nesting is a form of flexibility by underspecification.” [38].</p>
<p><b>TriGSflow</b></p>	<p><b>Reusability:</b> “Object-oriented Paradigm: The object-oriented paradigm supports among others the modeling of structure and behavior of problem domain objects which may be reused for building different workflow systems [...] The integration of internal object-oriented applications promotes the reusability of classes of the problem domain to which the business process belongs. In object-oriented applications behavior is realized by methods associated to classes. In TriGSflow these methods are reused for the implementation of activities.” [91]</p>
<p><b>WASA<sub>2</sub></b></p>	<p><b>Reusability:</b> “We put our emphasis on the following: [...] Integration: An important functionality of a workflow management system is the integration of existing software systems in a single workflow application. A recent trend towards developing information systems is using business objects. A workflow management system should support the integration of business objects in workflow applications”. [50]</p> <p><b>Flexibility by change:</b> “Flexibility: Support for partially specified or dynamically changing application processes is not available in first generation workflow management systems. This limitation creates one of the main obstacles for the deployment of workflow applications, because workflow users and workflow administrators often encounter situations which require a dynamic change...” [50]</p>
<p><b>Product-based workflow design</b></p>	<p><b>Process optimization:</b> “[...] we allow for multiple optimization criteria to be included simultaneously in ordering the tasks in a design” [9]. “we are focusing in this paper on the optimal choices for the case (i.e. regarding throughput time, cost, etcetera).” [72]</p> <p><b>Flexibility by change:</b> “[...] takes into consideration that any end product is subject to (frequent) change. [...] four change primitives are studied, and they are considered to be the only elemental changes needed to accomplish any other change to a product data model.” [71]</p>
<p><b>Case Handling</b></p>	<p><b>Context tunneling, flexibility:</b> “[...] By using a data-driven approach combined with implicit routing and carefully avoiding context tunneling, awareness and flexibility are improved”. [73]</p> <p><b>Flexibility by design:</b> “The modeling approach of CHS’s is called implicit modeling. [...] implicit modeling should support a better flexibility of the system. Note that this type of flexibility aims at expected exceptions.” [73]</p> <p><b>Flexibility by deviation:</b> “user of the system at runtime is able to redo, bypass or rollback these tasks, possibly diverging from the normal flow”. [73]</p>

Table C.1 Methods drives and motivators



## Appendix D. Case Description

Adapted from "Towards Designing Modular and Evolvable Business Processes", Pieter Van Nuffel, Universiteit Antwerpen 2011.

### Custom Bikes

A small company manufactures customized bicycles. Whenever the sales department receives an order, the order handling process starts. Due to the design complexity, every request to manufacture a customized bike denotes a separate order. In a first phase, the order is registered and added to the file of the existing customer. If a new customer places an order, a customer file will be created and the order is added. Then, the order is evaluated through (1) an engineering check and (2) a financial check. First, based on the number of parts and the way to procure them, the engineers determine the order type:

- If the bike consists of less than 100 parts, either bought or custom made, the order is categorized as "easy";
- If the bike has between 100 and 500 parts, the order is considered to be:
  - "easy": if all parts can be bought;
  - "difficult": if some parts need to be custom built.
- If the order consists of more than 500 parts, it is considered complex.

Second, the financial check depends on the outcome of the engineering check: if the order is easy and the calculated revenue of the order (which is done by a decision support system upon registration of the order) surpasses \$5,000, the order receives a financial OK status. A difficult order is only accepted if the revenue amounts to at least \$7,500; if the revenue ranges between \$5,000 and \$7,500, the order is attributed a Medium status. A complex order will only be accepted if the estimated revenue exceeds \$10,000, and receives a Medium evaluation if the revenue is between \$7,500 and \$10,000.

After the engineering and financial checks, a senior manager verifies the order to check whether it fits the style of the company. Orders with an OK financial status will be accepted, regardless of the manager's taste. Orders with a Medium financial evaluation will only be accepted if the evaluation of the manager is high. If the financial evaluation was not ok, the order will be rejected, unless it denotes a special purpose bike, which will always be produced. In case the order is rejected, the customer receives a notification. If the order is accepted, the storehouse and the engineering department are informed.

The engineering department starts with including the order in the production schedule and performs a number of assembly preparation tasks; the storehouse immediately processes the part list of the order and checks the required quantity of each part. If the part is available in-house (inventory), it is reserved. If it is not available, it is back-ordered. In that case, the lead-engineer will first draft each part's requirements. These part requirements are then submitted to different manufacturers. The quotes received from the manufacturers are then evaluated. This evaluation assesses both the quote and the manufacturer: payment terms, quality assurance and delivery options. After the quotes' evaluation, the best manufacturer is chosen for each part and the parts are ordered. If no manufacturer can be found for a part, a "back order failed" error

is thrown. At that moment, the company will contact the customer to inform him of the difficulties with the order and proposes him to submit a new order; the current order is canceled. If the order is canceled, the engineering department stops the preparation of the assembly, and the manufacturing planning is changed. The procured parts that were already reserved are released. When all parts are ready and the engineering department has planned the production of the bike, the bike is assembled. After assembly, the bike is shipped and invoiced. If the order value is less than \$15,000, the bike will immediately be shipped, otherwise it will be shipped after receiving the customer's payment.

## Appendix E. Product-Based Workflow Design Models

Specifications based on PBWD consist of the following elements provided for the custom bikes process:

- Description of data elements
- Description of the production rules
- Product-Data Model

### Data Elements

Data Element	Description
i1	Customer Order
i2	Customer File
i3	Bike number of parts
i4	Parts' way of procurement ( <i>custom, bought</i> )
i5	Order type ( <i>easy, difficult, complex</i> )
i6	Order revenue
i7	Order financial evaluation ( <i>OK, Medium, Not OK</i> )
i8	Style of the company guide
i9	Manager's evaluation of style
i10	Special purpose bike
i11	Order evaluation ( <i>accepted, rejected</i> )
i12	Production Schedule
i13	Part list (part/qty required)
i14	Inventory
i15	Parts Status
i16	Parts requirements
i17	Quotes
i18	Quotes' payment terms
i19	Quotes' quality assurance
i20	Quotes' delivery options
i21	Quotes' evaluation
i22	Vendors selection
i23	Backordered material ready
i24	Bike is assembled
i25	Order value
i26	Invoice
i27	Payment
i28	Shipment
i29	Decision to close an order

Table E.1 Data Elements

## Production Rules

The following table contains the production rules for the Product-Data Model. The input elements for each rule are enclosed in brackets {}; empty brackets denote that no input elements are needed for executing that rule. Constraint column includes those that apply to the production rule and the last column describes the production rule. \*i indicates the value for the data element i. The present design abstracts from the cost, time and probability elements.

Production rule	Constraint	Description
(i1,{} )	TRUE	Customer Order is received at sales department.
(i2,{i1})	TRUE	Order is added to customer's file. If customer is new, file is created first.
(i3,{i2})	TRUE	Determine bike's number of parts.
(i4,{i2})	TRUE	Determine way to procure parts: 'bought' or 'custom made'.
(i5,{i3,i4})	TRUE	Determine type according to order characteristics. If: <ul style="list-style-type: none"> <li>parts&lt;100 then order is Easy.</li> <li>100≤parts≤500. If parts can be bought then order is easy; if some parts need to be custom built then order Difficult.</li> <li>parts ≥500 then order is Complex.</li> </ul>
(i6,{i2})	TRUE	Decision support system calculates order revenue.
(i7,{i5,i6})	TRUE	Determine financial status of the order. <ul style="list-style-type: none"> <li>For Easy orders: If revenue&gt;\$5,000 then OK status; otherwise Medium status.</li> <li>For Difficult orders: If revenue&gt;\$7,500 then OK status; if \$5,000≤revenue≤\$7,500 then Medium status; otherwise Not OK status.</li> <li>For Complex orders: If revenue&gt;\$10,000 then OK status; if \$7,500≤revenue≤\$10,000 then Medium status; otherwise Not OK status.</li> </ul>
(i8,{} )	TRUE	Company guidelines on bikes' styles.
(i9,{i8})	TRUE	Manager evaluates bike according to company style guidelines.
(i10,{i2})	TRUE	Determine if order relates to a special purpose bike.
(i11,{i7})	*i7='OK'	Evaluate order. Order is accepted if financial status is OK.
(i11,{i7,i9,i10})	*i7='Medium' and *i9 defined and *i10 defined	Evaluate order. Order is accepted if financial status is Medium and Manager's evaluation is High; if manager's evaluation is not high then order is rejected unless it is a special purpose bike.
(i11,{i7,i10})	*i7='Not OK' and *i10 defined	Evaluate order. If financial status is 'Not OK' order is rejected unless it is a special purpose bike which is accepted.

Production rule	Constraint	Description
(i11,{i10})	*i10='TRUE'	Evaluate order. Order is accepted if it denotes a special purpose bike.
(i12,{i2,i11})	*i11='Accepted'	Include order in the production schedule.
(i13,{i2,i11})	*i11='Accepted'	Determine part list of accepted order (parts/quantity required).
(i14,{})	TRUE	Get Inventory.
(i15,{i13,i14})	TRUE	Get part status. If all parts are available then status is 'Reserved'; if some parts are missing then status is 'Backorder pending'.
(i16,{i15})	*i15='backorder pending'	Determine Part requirements for missing parts and submit to manufacturers.
(i17,{})	*i16 defined	Receive quotes from manufacturers.
(i18,{i17})	TRUE	Get Quotes' payment terms.
(i19,{i17})	TRUE	Get Quotes' quality assurance.
(i20,{i17})	TRUE	Get Quotes' delivery options.
(i21,{i18,i19,i20})	TRUE	Evaluate quotes according to payment, quality and delivery characteristics.
(i22,{i21})	TRUE	Vendors are selected based on quotes' evaluation or 'backorder failed' status is indicated if a part cannot be supplied.
(i23,{i22})	*i22!='backorder failed'	Procure parts with selected vendors and reserve them.
(i24,{i12,i15})	*i15='reserved' and *i12 defined	Assembly bike when all parts are reserved and production schedule is updated.
(i24,{i12,i15,i23})	*i15='backorder pending' and *i12 defined and *i23='reserved'	Assembly bike when production schedule is updated and backordered material is ready.
(i25,{i12})	TRUE	Determine order value.
(i26,{i24,i25})	*i24='assembled' and i25 defined	Generate invoice with order value.
(i27,{i26})	TRUE	Receive customer payment.
(i28,{i24,i25})	*i24='assembled' and *i25<\$15,000	Ship bike immediately if order value less than \$15,000.
(i28,{i24,i25,i27})	*i24='assembled' and *i25≥\$15,000	Ship bike after receiving payment if order value equal or more than \$15,000.
(i29,{i27,i28})	*i27 defined and *i28 defined	Close order when payment is received and bike is delivered.
(i29,{i11})	*i11='rejected'	Close order due to rejection.
(i29,{i22})	*i22='backorder failed'	Close order due to backorder failure; release reserved parts and cancel production order.

Table E.2 Production rules

Product-Data Model

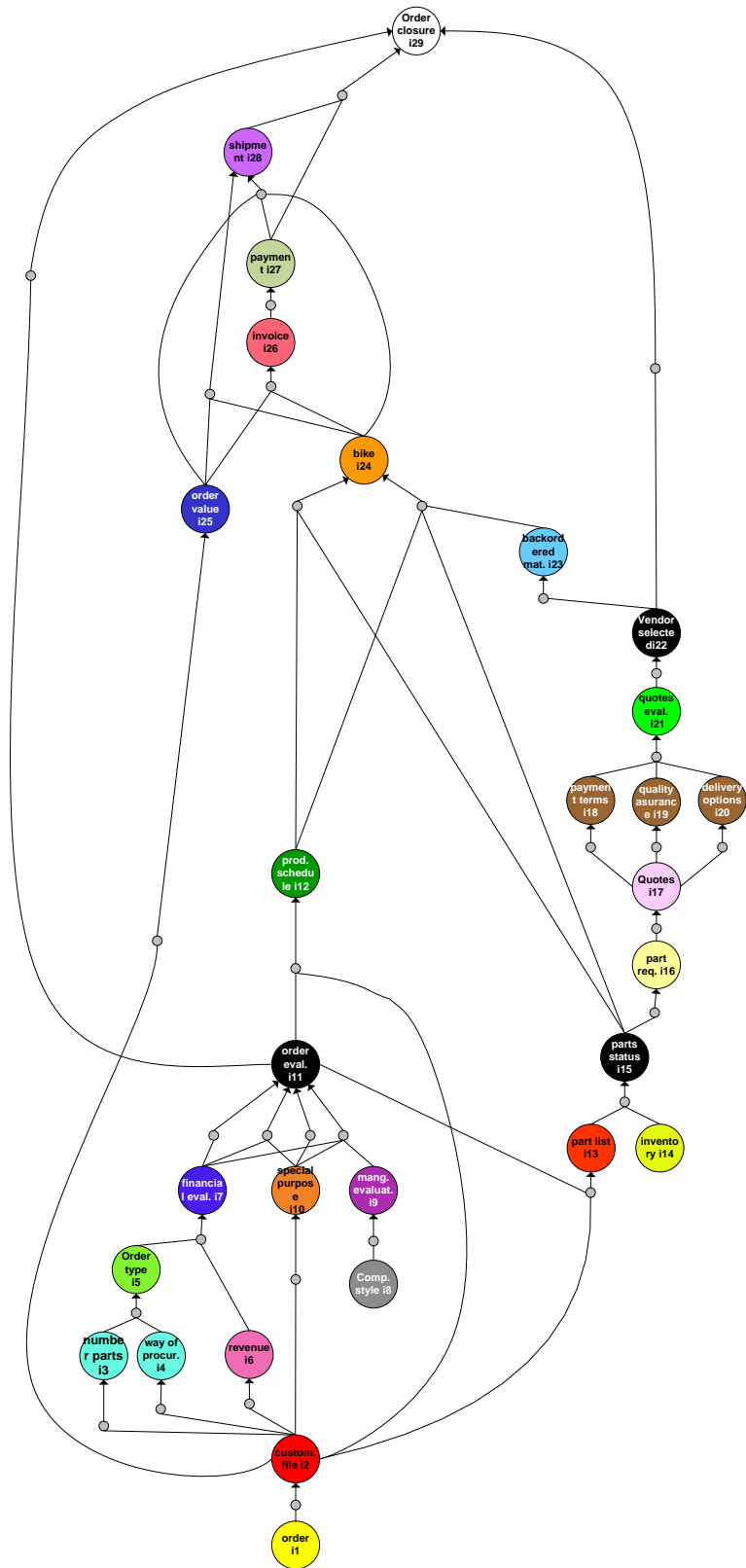

Figure E.1 Product-data model

## Appendix F. Data-Driven Process Structures Models

Data-driven process structures specifications consist of the following main elements:

- Definition of a data model: objects and their relation types
- Definition of each object's lifecycle: the different states of an object and the processes needed to process the object and transform its state
- Definition of sub-processes dependencies based on the objects relations

These elements allow the definition of multiple process structures (instance level).

### Data Model

Data model with the objects and relationships identified in the custom bikes case.

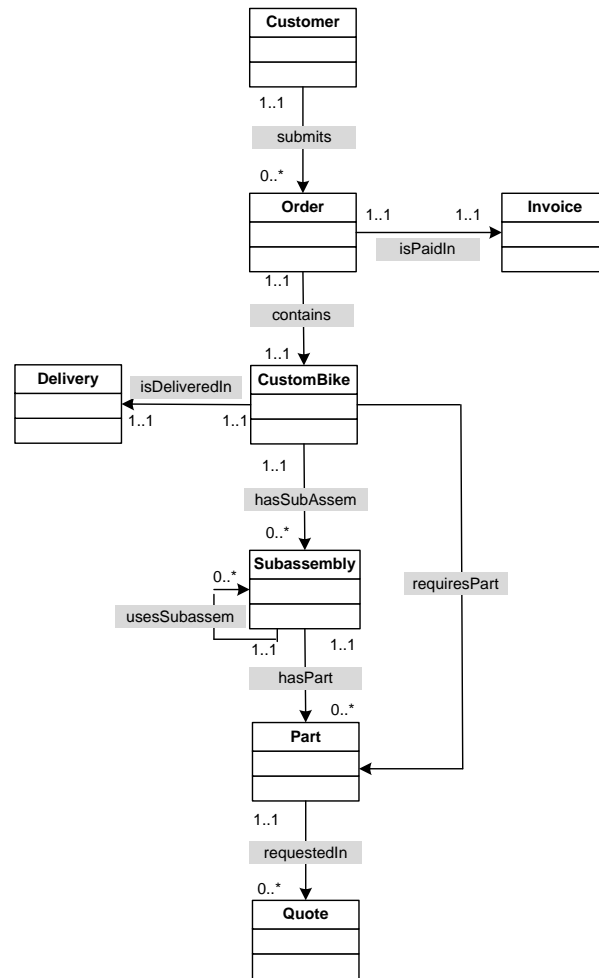
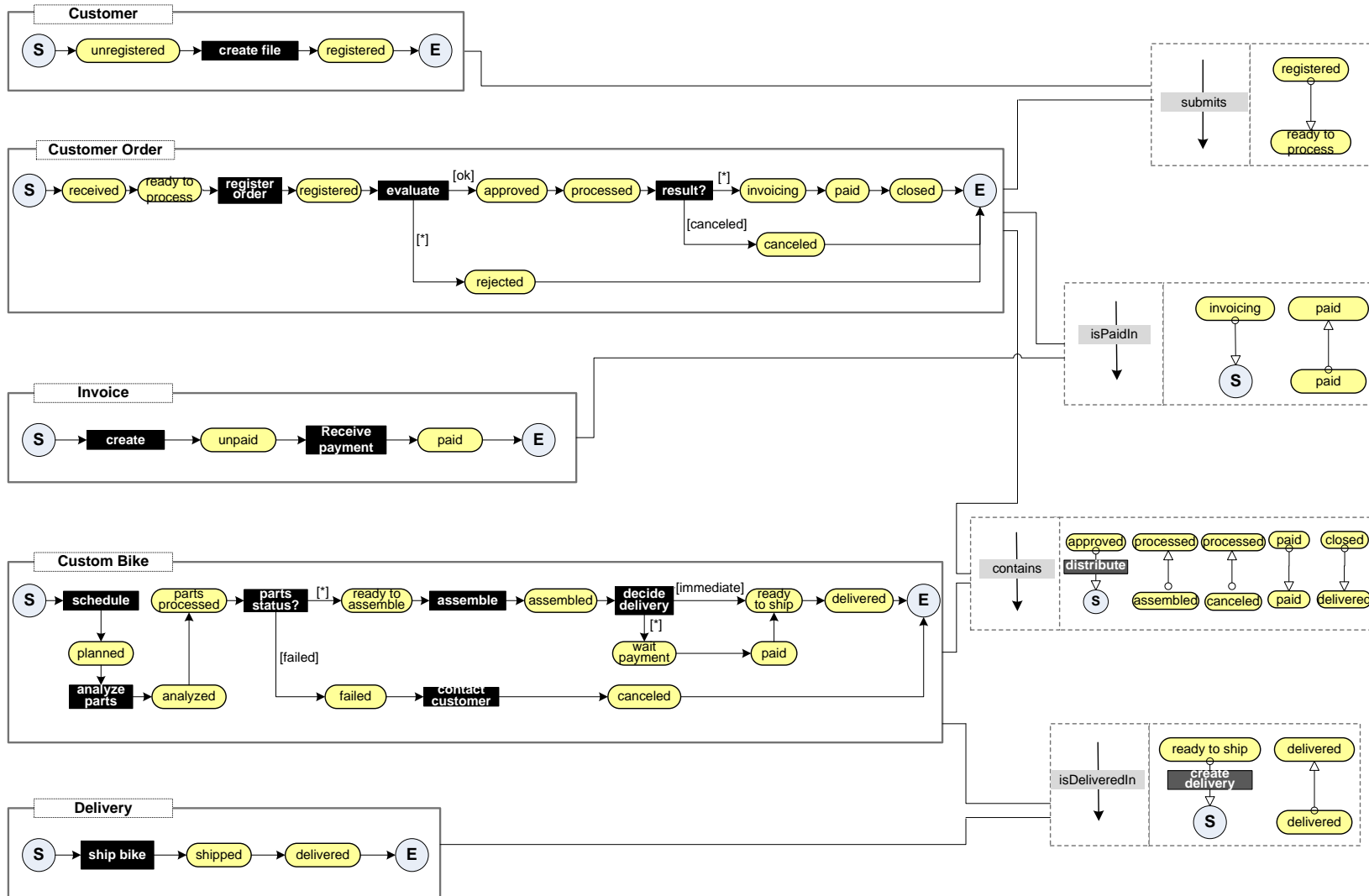
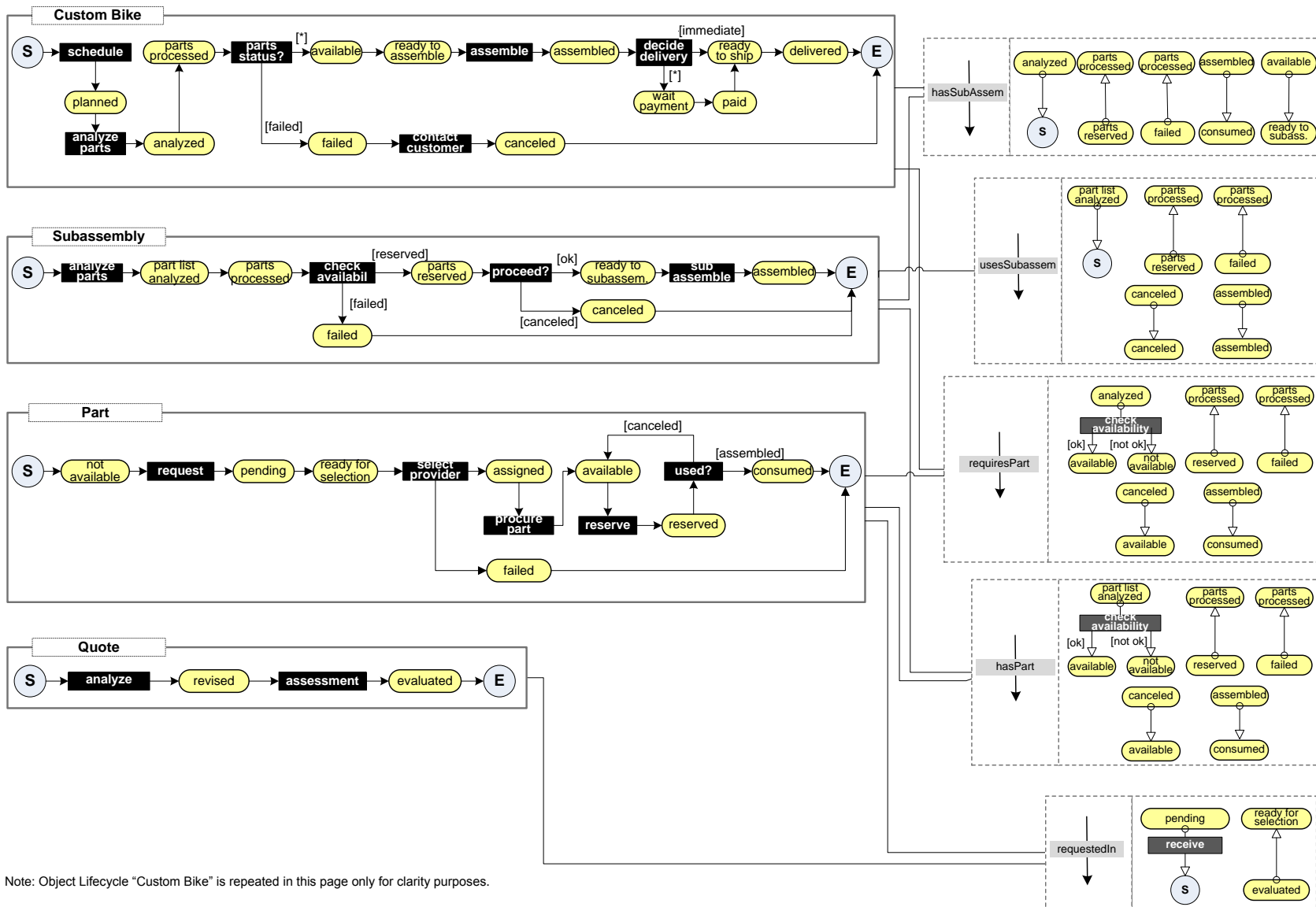

Figure F.1 Custom bikes data model

### Lifecycle Coordination Model







Note: Object Lifecycle "Custom Bike" is repeated in this page only for clarity purposes.

Figure F.2 Lifecycle Coordination Model

## Appendix G. Artifact-Centric Business Process Models

The basic form of the artifact-centric framework, called *BALSA<sub>Basic</sub>*, consists of Entity-Relationship models for specifying artifacts; finite state machines for lifecycle definition; definition of input, output, pre-conditions and effects for service specification; and ECA rules to define associations between services and artifacts.

### Business Artifacts Information Model

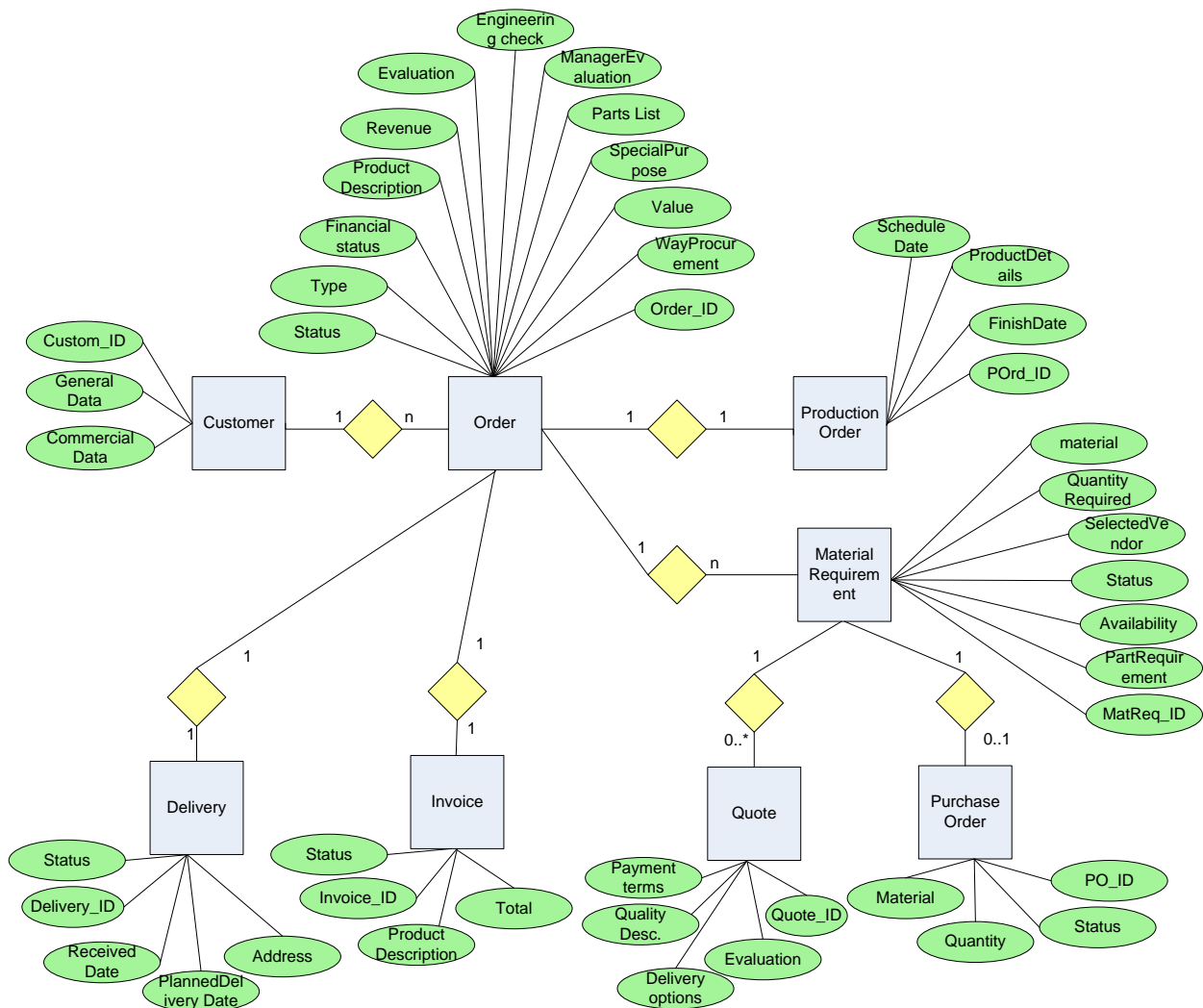
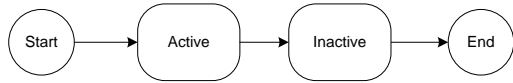

Figure G.1 Business artifacts for the custom bikes case

## Macro-Level Lifecycles

The following finite-state machines show the most relevant states for each business artifact. Consider that at this level transitions conditions are kept at a minimum level.

Customer



Order

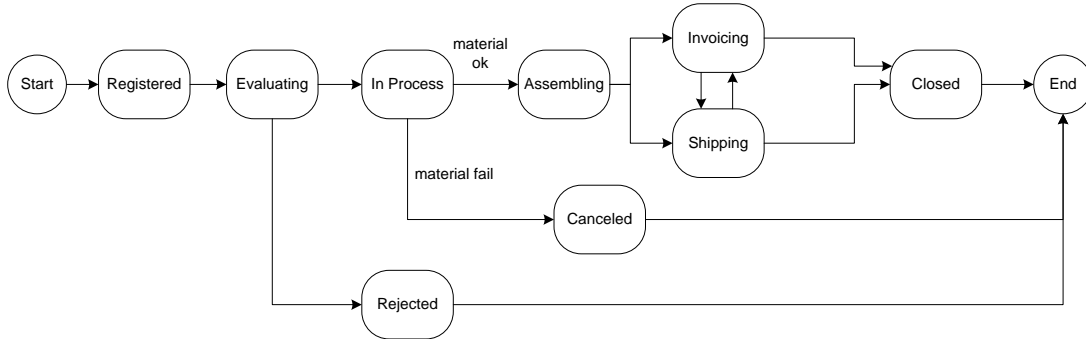

Delivery

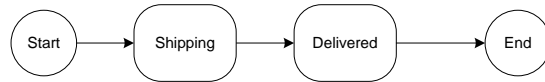

Invoice

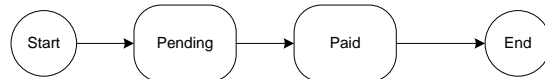

Production Order

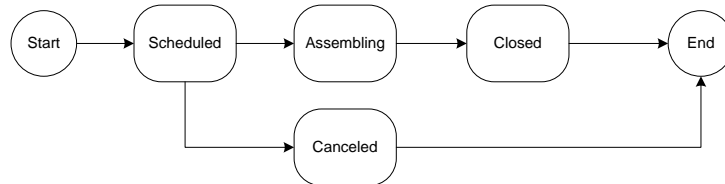

Material Requirement

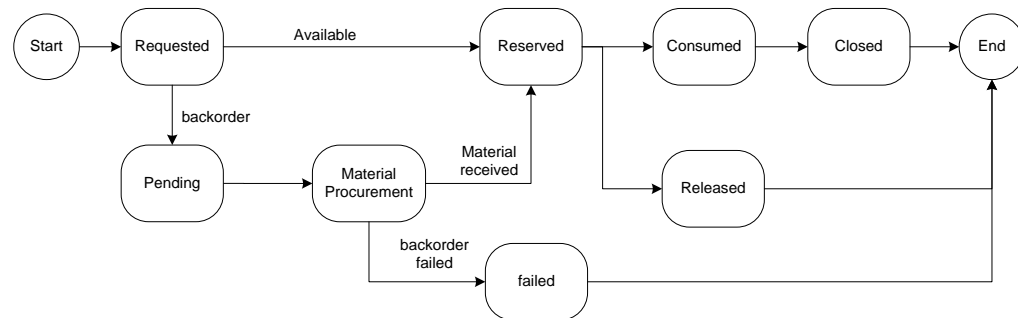

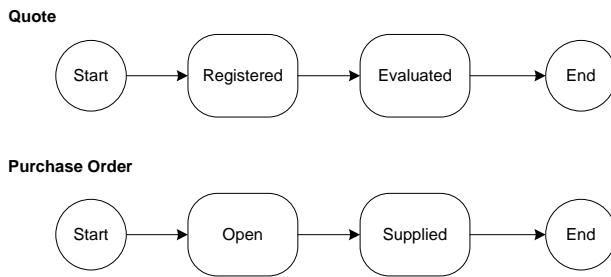

Figure G.2 Business artifacts lifecycles

### Services

Library of services associated to the business artifacts using the Input & Output artifacts, Preconditions and Effects.

<b>Service</b>	<i>CreateCustomerProfile</i>
Input	{}
Output	{c: Customer}
Pre-Condition	Non existing customer
Effects	DEFINED(c.Custom_ID) AND DEFINED(c.GeneralData) AND DEFINED(c.CommercialData) AND <b>Active(c)</b>

<b>Service</b>	<i>RegisterOrder</i>
Input	{c:Customer}
Output	{o:Order}
Pre-Condition	<b>Active(c)</b>
Effects	DEFINED(o.ProductDescription) AND DEFINED(o.PartsList) AND DEFINED(o.SpecialPurpose) AND DEFINED(o.Revenue) AND DEFINED(o.Value) AND DEFINED(o.WayProcurement) <b>Registered(o)</b>

<b>Service</b>	<i>EngineeringCheck</i>
Input	{o:Order}
Output	{o:Order}
Pre-Condition	DEFINED(o.PartsList) AND DEFINED(o.WayProcurement)
Effects	DEFINED(o.Type) if: <ul style="list-style-type: none"> <li>• parts&lt;100 then o.Type=Easy.</li> <li>• 100≤parts≤500. If parts can be bought then o.Type=Easy; if some parts need to be custom built then o.Type=Difficult.</li> <li>• parts ≥500 then o.Type=Complex</li> </ul>

<b>Service</b>	<i>FinancialCheck</i>
Input	{o:Order}
Output	{o:Order}
Pre-Condition	DEFINED(o.Type) AND DEFINED(o.Revenue)
Effects	DEFINED(o.FinancialStatus) <ul style="list-style-type: none"> <li>• For o.Type=Easy: If revenue&gt;\$5,000 then OK status; otherwise Medium status.</li> <li>• For o.Type=Difficult: If revenue&gt;\$7,500 then OK status; if \$5,000≤revenue≤\$7,500 then Medium status; otherwise Not OK status.</li> <li>• For o.Type=Complex: If revenue&gt;\$10,000 then OK status; if \$7,500≤revenue≤\$10,000 then Medium status; otherwise Not OK status.</li> </ul>

<b>Service</b>	<i>SeniorEvaluation</i>
Input	{o:Order}
Output	{o:Order}
Pre Condition	
Effects	DEFINED(o.ManagerEvaluation)

<b>Service</b>	<i>EvaluateOrder</i>
Input	{o:Order}
Output	{o:Order}
Pre-Condition	DEFINED(o.ManagerEvaluation) AND DEFINED(o.FinancialStatus) AND DEFINED(o.SpecialPurpose)
Effects	DEFINED(o.Evaluation) <ul style="list-style-type: none"> <li>o.Evaluation='accepted' if: (FinancialStatus='Medium' and ManagerEvaluation='High') or (FinancialStatus='OK') or (SpecialPurpose=TRUE).</li> <li>o.Evaluation='rejected' otherwise.</li> </ul>

<b>Service</b>	<i>GenerateProductionOrder</i>
Input	{o:Order}
Output	{p:ProductionOrder}
Pre-Condition	o.Evaluation='Accepted'
Effects	DEFINED(p.ScheduledDate) AND DEFINED(p.ProductDetails) AND DEFINED(p.POrd_ID) <b>Scheduled</b> (p)

<b>Service</b>	<i>GenerateMaterialRequirement</i>
Input	{o:Order}
Output	{m1,m2,..,mx:MaterialRequirement}
Pre-Condition	o.Evaluation='Accepted'
Effects	for each material in o.PartList: DEFINED(m.Material) AND DEFINED(m.QuantityRequired) AND DEFINED(m.Availability)  If m.quantityRequired>available then m. Availability = 'Backorder pending' else m. Availability = 'Available' <b>Requested</b> (m)

<b>Service</b>	<i>Request for Quote</i>
Input	{m:MaterialRequirement}
Output	{m:MaterialRequirement}
Pre-Condition	m.Status='Backorder pending'
Effects	DEFINED(m.PartRequirement)

<b>Service</b>	<i>Receive Quote</i>
Input	{m:MaterialRequirement}
Output	{q:Quote}
Pre-Condition	m.Status='Backorder pending'
Effects	DEFINED(q.Quote_ID) AND DEFINED(q.PaymentTerms) AND DEFINED(q.QualityDes) AND DEFINED(q.DeliveryOptions) <b>Registered</b> (q)

<b>Service</b>	<i>EvaluateQuote</i>
Input	{q:Quote,m:MaterialRequirement}
Output	{q:Quote}
Pre-Condition	m.Status='Backorder pending'
Effects	DEFINED(q,*)

<b>Service</b>	<i>SelectVendor</i>
Input	{ q1,...,qx:Quote, m:MaterialRequirement }
Output	{m:MaterialRequirement}
Pre-Condition	DEFINED(q.Evaluation) for all q
Effects	DEFINED(m.SelectedVendor) If no vendor is selected then m.SelectedVendor='backorder failed'

APPENDIX G. ARTIFACT-CENTRIC BUSINESS PROCESS MODELS

<b>Service</b>	<i>GeneratePurchaseOrder</i>
Input	{m:MaterialRequirement,q:Quote}
Output	{p:PurchaseOrder}
Pre-Condition	m.SelectedVendor!= 'backorder failed'
Effects	DEFINED(p.Material) AND DEFINED(p.Quantity) AND DEFINED(p.Status) AND DEFINED(p.PO_ID) <b>Open</b> (p)

<b>Service</b>	<i>ReceiveMaterial</i>
Input	{p:PurchaseOrder,m:MaterialRequirement}
Output	{p:PurchaseOrder,m:MaterialRequirement}
Pre-Condition	
Effects	DEFINED(p.Status) AND DEFINED(m.Availability)

<b>Service</b>	<i>CancelOrder</i>
Input	{o:Order,m1,...,mx:MaterialRequirement}
Output	{o:Order,m1,...,mx:MaterialRequirement}
Pre-Condition	
Effects	DEFINED(o.Status) AND DEFINED(m.Status) for all Material Requirement m1..mx

<b>Service</b>	<i>AssemblyBike</i>
Input	{o:Order,m1..mx:MaterialRequirement, p:ProductionOrder}
Output	{o:Order,m1..mx:MaterialRequirement, p:ProductionOrder}
Pre-Condition	Reserved(m) for all m AND Scheduled(p)
Effects	DEFINED(o.Status) AND DEFINED(m.Status) AND DEFINED(p.Status) AND DEFINED(p.FinishDate)

<b>Service</b>	<i>ShipBike</i>
Input	{o:Order,p:ProductionOrder}
Output	{o:Order,d:Delivery}
Pre-Condition	Closed(p)
Effects	DEFINED(o.Status) AND DEFINED(d.PlannedDeliveryDate) AND DEFINED(d.Address) AND DEFINED(d.Delivery_ID) <b>Shipping</b> (d)

<b>Service</b>	<i>Invoicing</i>
Input	{o:Order}
Output	{o:Order,i:Invoice}
Pre-Condition	
Effects	DEFINED(o.Status) AND DEFINED(i.*) <b>Pending</b> (i)

<b>Service</b>	<i>ContactCustomer</i>
Input	{o:Order,c:Customer}
Output	{o:Order}
Pre-Condition	
Effects	DEFINED(o.Status) <b>Pending</b> (i)

## Associations

Associations are specified using Event-Condition-Action rules indicating which services are applied on which artifacts and when. Rules with no triggering events indicate that the action can be fired anytime that the condition is true.

<b>Rule 1</b>	<i>Register New Customer</i>
Events	Order is received
Conditions	Customer is not registered
Actions	<b>invoke</b> <i>CreateCustomerProfile()</i>
<b>Rule 2</b>	<i>Register Order</i>
Events	New Order is received
Conditions	Active(Customer)
Actions	<b>invoke</b> <i>RegisterOrder(Customer c)</i>
<b>Rule 3</b>	<i>Perform Engineering Check</i>
Events	Request by performer to Execute Engineering Check on <i>Order o</i>
Conditions	Registered(o)
Actions	<b>invoke</b> <i>EngineeringCheck (Order o)</i> <b>change state to</b> <i>Evaluating(o)</i>
<b>Rule 4</b>	<i>Perform Financial Check</i>
Events	Request by performer to Execute Financial Check on <i>Order o</i>
Conditions	DEFINED(o.Type) AND DEFINED(o.Revenue)
Actions	<b>invoke</b> <i>FinancialCheck (Order o)</i>
<b>Rule 5</b>	<i>Perform Senior Evaluation</i>
Events	Request by performer to Execute Senior Evaluation on <i>Order o</i>
Conditions	DEFINED(o.Type) AND DEFINED(o.FinancialStatus)
Actions	<b>invoke</b> <i>SeniorEvaluation (Order o)</i>
<b>Rule 6</b>	<i>Evaluate Order</i>
Conditions	For Order o: DEFINED(o.Type) AND DEFINED(o.FinancialStatus) AND DEFINED(o.ManagerEvaluation)
Actions	<b>invoke</b> <i>EvaluateOrder(o)</i>
<b>Rule 7</b>	<i>RejectOrder</i>
Events	Order o.Evaluation is assigned
Conditions	o.Evaluation='rejected'
Actions	<b>invoke</b> <i>ContactCustomer(Order o, Customer c)</i> <b>change state to</b> <i>Rejected(o)</i>
<b>Rule 8</b>	<i>Accept Order</i>
Events	Order o.Evaluation is assigned
Conditions	o.Evaluation='accepted'
Actions	<b>change state to</b> <i>InProcess(o)</i>
<b>Rule 9</b>	<i>Create Production Order</i>
Events	Order o enters state InProcess
Conditions	True
Actions	<b>invoke</b> <i>GenerateProductionOrder (Order o)</i>

APPENDIX G. ARTIFACT-CENTRIC BUSINESS PROCESS MODELS

<b>Rule 10</b>	<i>Material Requirement Request</i>
Events	Order o enters state InProcess
Conditions	True
Actions	<b>invoke</b> GenerateMaterialRequirement (Order o)
<b>Rule 11</b>	<i>Not Available Material</i>
Conditions	Material Requirement m.Availability='Backorder pending'
Actions	<b>change state to</b> Pending(m)
<b>Rule 12</b>	<i>Reserve Material</i>
Conditions	Material Requirement m.Availability="Available"
Actions	<b>change state to</b> Reserved(m)
<b>Rule 13</b>	<i>Request for Material</i>
Events	Request by Performer to Execute Request for Quote for Material Requirement m
Conditions	m.Availability='Backorder pending'
Actions	<b>invoke</b> RequestForQuote(Material Requirement m) <b>change state to</b> MaterialProcurement(m)
<b>Rule 14</b>	<i>Receive Quote</i>
Events	Quote q is received from Provider
Conditions	Quote for pending material m
Actions	<b>invoke</b> ReceiveQuote(Material Requirement m)
<b>Rule 15</b>	<i>Evaluate Quote</i>
Events	Request by Performer to Execute Evaluate Quote
Conditions	Quote for pending material m
Actions	<b>invoke</b> EvaluateQuote(Quote q, Material Requirement m)
<b>Rule 16</b>	<i>Select Vendor</i>
Events	Request by Performer to Execute Select Vendor
Conditions	For each Quote q of Material Requirement m, q.Evaluation is Defined
Actions	<b>invoke</b> SelectVendor(Quote q1,...,qx, MaterialRequirement m)
<b>Rule 17</b>	<i>Backorder failed</i>
Events	Selected Vendor for Material Requirement m is defined
Conditions	m.SelectedVendor="backorder failed"
Actions	<b>change state to</b> Failed(m)
<b>Rule 18</b>	<i>Submit Purchase Order</i>
Events	Selected Vendor for Material Requirement m is defined
Conditions	m.SelectedVendor!="Failed"
Actions	<b>invoke</b> GeneratePurchaseOrder(MaterialRequirement m,Quote q)
<b>Rule 19</b>	<i>Receive Material</i>
Events	Material sent by provider
Conditions	Exists an Open Purchase Order p for Material Requirement m
Actions	<b>invoke</b> ReceiveMaterial(Purchase Order p, Material Requirement m) <b>change state to</b> Supplied(p) <b>change state to</b> Reserved(m)
<b>Rule 20</b>	<i>Cancel Order</i>
Events	For the first Material Requirement m that is defined with m.SelectedVendor="backorder failed"



APPENDIX G. ARTIFACT-CENTRIC BUSINESS PROCESS MODELS

---

Conditions	m.SelectedVendor="backorder failed"
Actions	<b>Invoke</b> CancelOrder(o) <b>Change state to</b> Canceled(o) <b>Change state to</b> Released(m) for all Reserved(m) of Order o <b>Change state to</b> Canceled(p) for Production Order p
<b>Rule 21</b>	<i>Start Assembling</i>
Events	Request by Performer to Execute Assembly Bike for Production Order p
Conditions	For all Material Requirement m1..mx: Reserved(m) AND Scheduled(p) AND InProcess(Order o)
Actions	<b>Invoke</b> AssemblyBike(Order o, Material Requirement m, Production Order p) <b>Change state to</b> Assembling(p) <b>Change state to</b> Assembling(o) <b>Change state to</b> Consumed(m) for all m
<b>Rule 22</b>	<i>Bike is Assembled</i>
Events	ProductionOrder p.FinishDate is defined
Conditions	True
Actions	<b>Change state to</b> Closed(p)
<b>Rule 23</b>	<i>Ship Bike</i>
Conditions	(Closed(Production Order) AND Order.Value<15000) OR (Closed(Production Order) AND Order.Value≥15000 AND Paid(Invoice))
Actions	<b>Invoke</b> ShipBike(Order o, Production Order p) <b>Change state to</b> Shipping (o)
<b>Rule 24</b>	<i>Bike is Delivered</i>
Events	Delivery d.ReceivedDate is Defined
Conditions	True
Actions	<b>Change state to</b> Delivered(d)
<b>Rule 25</b>	<i>Process Invoice</i>
Events	Request by Performer to execute Invoicing
Conditions	Production Order p.FinishDate is defined
Actions	<b>Invoke</b> Invoicing(Order o) <b>Change state to</b> Invoicing(Order o)
<b>Rule 26</b>	<i>Payment is Received</i>
Events	Payment for Invoice i is received
Conditions	True
Actions	<b>Change state to</b> Paid(Invoice i)
<b>Rule 27</b>	<i>Close Order</i>
Conditions	Paid(Invoice i) AND Delivered(Delivery d)
Actions	<b>Change state to</b> Closed(Order o)

## Appendix H. Data-Centric Modeling Approaches Survey

### Page 1. Introduction

Dear participant:

The present research aims at analyzing different characteristics of process modeling methods that make a more extensive use of data. Unlike the traditional activity-centric approaches where the focus is mainly on the sequencing and control of activities, the data-oriented methods presented here consider data as the central entity that drives the process modeling.

In the following pages you will learn different modeling methods and observe different ways of modeling a common case. After that you will answer some questions on your thoughts on each modeling method. The questions are directed to your thoughts as the process modeler and for each method. A description on the rules of each method and their respective models will be given to you as input to answer some questions. When answering the questions consider that all methods have comparable tool support.

This survey is targeted at conceptual and process modeling practitioners, researchers and students. All the information provided will be treated confidentially and used for the only purpose of this research. Answers will not be linked directly to any respondent and they will be used only for obtaining statistics relevant to this study.

The survey takes around 45-60 minutes. Especially the reading of the applications of the methods to the case description will take some time. It is also possible to take the survey in different sessions by using the "Save and continue survey later" button located at the top of every page in the survey.

The survey is conducted by:

Hector Diaz, master student at Eindhoven University of Technology

under the supervision of

dr.ir. Hajo Reijers

If you have any questions or wish to know more about the present research, please do not hesitate to contact me:

[h.d.diaz.garcia@student.tue.nl](mailto:h.d.diaz.garcia@student.tue.nl)

Thank you for your participation.

Kind regards,

Hector Diaz

**Page 2. Demographic Questions**

1.) What is your gender?

- Male
- Female

2.) What is your age?

- Under 18
- 18-24
- 25-34
- 35-50
- Older than 50 years

3.) What region do you live in?

- Asia
- Africa
- Europe
- North America
- Latin America
- Australia

4.) What is your position?

- Academic
- Student
- Business Analyst
- Solution Architect
- Software Engineer
- Developer
- Process Owner
- Process Manager
- Process Analyst
- Process Administrator
- Other

**Page 3. Organization Information**

5.) What is your company size?

- Less than 20
- 20-99
- 101-1000
- 1001-5000
- More than 5000

6.) Which option better describes your company primary business activity?

- Energy
- Basic Materials (Chemicals, Metals, Construction Materials, etc.)
- Industrials (Capital Goods, Transportation, Commercial & Professional Services)
- Consumer Goods & Services (Food, Retailing, Media, Automobiles, etc.)
- Financial Services/Insurance
- Healthcare
- Information Technology
- Telecommunication Services
- Utilities (Electric, Gas, Sanitation, Water)
- Public Administration (Government)

**Page 4. Your Experience with Business Process Modeling**

7.) How experienced are you in Business Process/Conceptual Modeling?

- Novice
- Intermediate
- Expert

8.) For which purposes have you done process modeling? Select all that apply

- Documentation/Requirement Analysis
- Process Management
- Process Guidance
- Process Improvement/Simulation
- Process Automation
- Not Applicable

9.) How many years of experience do you have with process modeling?

- 0-1 year
- 2-4 years
- 5-10 years
- 11-20 years
- Over 20 years

10.) Which of the following modeling techniques are you familiar with? Check all that apply

- Data Flow Diagram
- Event-Driven Process Chains (EPCs)
- HIPO Charts
- Unified Modeling Language (UML)
- EPCs
- BPEL
- IDEF
- State Transition Diagram

- Structured Charts
- System Flowcharts
- Workflow Modeling
- Entity-Relationship Diagrams (ER)
- Petri nets
- YAWL
- Business Process Modeling Notation (BPMN)
- Other
- Business Process Execution Language (BPEL)

11.) Are you familiar with any of the following modeling methods?

- Product-Based Workflow Design
- Artifact-Centric Modeling Method
- Data-Driven Process Structures (COREPRO)

### Page 5. Case Description

See Appendix D. Case Description.

### Page 6. Method 1 (e.g. Product-Based Workflow Design)

This page includes a document with the description of the Product-Based Workflow Design Method and its respective models.

Please open the document below and read the method description carefully. Observe how the Custom Bikes case is modeled based on this method.

The document with the method description and respective models can be obtained here:  
Product-Based Workflow Design

You can once again open the Custom Bikes case description document here: Case Description

After reading the method description and observing the method's constructs please proceed to the following page to answer some questions.

### Page 7. Method 1 (e.g. Product-Based Workflow Design) Questions

12.) I found Product-Based Workflow Design easy to learn.

- Strongly disagree
- Disagree
- Somewhat disagree
- Neither agree nor disagree

- Somewhat agree
- Agree
- Strongly agree

13.) I would find creating process specifications using Product-Based Workflow Design to be easy.

- Strongly disagree
- Disagree
- Somewhat disagree
- Neither agree nor disagree
- Somewhat agree
- Agree
- Strongly agree

14.) I would find it easy to model processes in the way I intended using Product-Based Workflow Design.

- Strongly disagree
- Disagree
- Somewhat disagree
- Neither agree nor disagree
- Somewhat agree
- Agree
- Strongly agree

15.) Overall, I find Product-Based Workflow Design useful for modeling processes.

- Strongly disagree
- Disagree
- Somewhat disagree
- Neither agree nor disagree
- Somewhat agree
- Agree
- Strongly agree

16.) I believe that this method would reduce the effort to model business processes.

- Strongly disagree
- Disagree
- Somewhat disagree
- Neither agree nor disagree
- Somewhat agree
- Agree
- Strongly agree

17.) Overall, I think using the method would be an improvement over a textual description of the business process.

- Strongly disagree
- Disagree
- Somewhat disagree
- Neither agree nor disagree
- Somewhat agree
- Agree
- Strongly agree

18.) I find the method useful for the purpose of providing input to systems design.

- Strongly disagree
- Disagree
- Somewhat disagree
- Neither agree nor disagree
- Somewhat agree
- Agree
- Strongly agree

**Page 8. Method 2**

Same description as Page 6 adapted for Method 2.

**Page 9. Method 2 Questions**

Same description as Page 7 adapted for Method 2.

**Page 10. Finish**

This is the end of the questionnaire.

26.) Please use the space below to provide any comment or feedback regarding the questionnaire or project.

27.) If you wish, you can provide your e-mail address to keep you informed on the results of the project.

\_\_\_\_\_

**Page 11. Thank You!**

Thank you for your participation in this project. Your answers are very important to us.